

Optronics

Optronics

www.optronics.com

2014 2015





One bright idea after another

Founded in 1972, Optronics is America's largest offshore manufacturer of vehicle safety and interior lighting for original equipment manufacturers and the aftermarket. We have achieved market leading positions through our commitment to customer satisfaction, industry compliance/ quality standards, frequent new product introductions and investment in the future.

Optronics is based in Tulsa, OK with manufacturing, testing and distribution centers in Oklahoma, Indiana, Toronto and Asia. We reliably supply our extensive OEM and aftermarket customer base who rely on the efficiencies of just-in-time inventories. With manufacturing at our ISO/TS-16949, ISO 14001, OHSAS 18001 and ISO 50001 facility in Taiwan, Optronics offers our customers manufacturing and quality excellence in competitive markets.

With complete design and FMVSS 108 testing capabilities located in Taiwan and Oklahoma, Optronics operates a two-tiered quality and compliance testing program. We can deliver the product you need with the confidence you deserve. Compliance documentation is maintained by PO and is available upon request.

Our dedication to product development has resulted in the broadest line of LED safety lighting in the industry. Product design and innovation is our core competency. Our in-house art production department provides our multi-industry customers with constant, current marketing material to help drive their business and profitability.

Muskogee, OK



Elkhart, IN



Tainan City, Taiwan

MEMBER OF:



All Optronics products conform to
DOT/SAE/FMVSS/CMVSS 108 standards
where applicable when applied according to
federal lighting requirements

CONTENTS

LED TRUCK & TRAILER LIGHTING	2 - 133
Head Lights	2
Sealed Stop/Turn/Tail Lights & Parking/Turn Signals	4
Surface Mount Combination Tail Lights & Kits	26
Back-Up Lights	46
Flashing Warning Lights	54
Millennium Series	56
Sealed Marker/Clearance Lights	62
Surface Mount Marker/Clearance Lights.....	88
ID Light Bars.....	101
License Plate Lights.....	105
Utility & Interior Lights	109
Work/Flood Lights.....	127
INCANDESCENT TRUCK & TRAILER LIGHTING	134 - 199
Sealed Recess Mount Stop/Turn/Tail Lights.....	134
Surface Mount Combination Tail Lights & Kits	137
Back-Up Lights	153
Millennium Series™ Marker/Clearance Lights.....	155
Sealed Marker/Clearance Lights	157
Surface Mount Marker/Clearance Lights.....	166
ID Light Bars.....	180
License Plate Lights.....	183
Utility & Interior Lights	193
Work/Flood Lights.....	197
RV LIGHTS & ACCESSORIES	200 - 230
ACCESSORIES - CONSPICUITY, MOUNTING, WIRING	231 - 258
FMVSS LIGHTING REQUIREMENTS	259 - 265
INDEX	266 - 273

Optronics International

OKLAHOMA: 401 South 41st Street East, Muskogee OK 74403
toll free: 800-364-5483 • phone: 918-683-9514 • fax: 918-683-9517

INDIANA: 420 Roske Drive, Elkhart IN 46516
toll free: 800-826-5483 • phone: 574-389-0040 • fax: 574-389-0041
website: www.optronicsinc.com • email: sales@optronicsinc.com



HLL88/89 SERIES DOT Compliant High and Low Beam Sealed LED Headlamps



HLL88LB



HLL89HB

- Replace standard 4" x 6" sealed beam halogen and HID headlamps
- Light output whiter than incandescent for greater visibility
- Long lasting, energy efficient – diodes last up to 50 times longer than incandescent, draw less than 1 amp
- Dual power: use with 12VDC or 24VDC systems
- Hard wired with standard H4 3-blade connector; 16 gauge, 7-inch leads
- Die cast aluminum construction with powder coat finish resists corrosion
- Tough polycarbonate lens

BULK P/N	POLYPACK P/N	DESCRIPTION	QTY
LOW BEAM HEADLAMP - 8 DIODES			
HLL88LB	HLL88LBP	12-24VDC Low beam	1
HIGH BEAM HEADLAMP - 8 DIODES			
HLL89HB	HLL89HBP	12-24VDC High beam	1

HLL88LB: 12.8VDC - 23.7W / 28VDC - 23.7W

HLL89HB: 12.8VDC - 23.7W / 28VDC - 23.7W

IP67 rating: protected from dust and capable of withstanding water immersion, offering increased reliability and service life

FMVSS	HL
MATERIALS	Polycarbonate lens, aluminum housing
VOLT/AMP	12.8VDC - 0.85A
WT/DIMS	1.14 lbs. / 6.563" x 4.188" x 3.313"
WARRANTY	Three Year Warranty

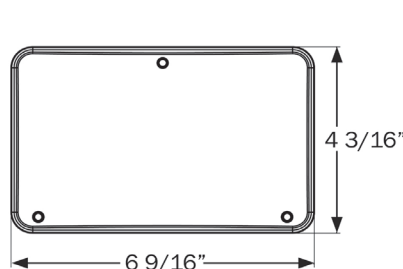

HLL90 SERIES

DOT Compliant High/Low Beam Sealed LED Headlamp



- Replace standard 7" sealed beam halogen and HID headlamps
- Light output whiter than incandescent for greater visibility
- Long lasting, energy efficient – diodes last up to 50 times longer than incandescent, draw less than 1 amp
- Dual power: use with 12VDC or 24VDC systems
- Hard wired with standard H4 3-blade connector; 16 gauge, 7-inch leads
- Die cast aluminum construction with powder coat finish resists corrosion
- Tough polycarbonate lens



HLL90HLB



BULK P/N	POLYPACK P/N	DESCRIPTION	QTY
HIGH/LOW BEAM HEADLAMP - 16 DIODES			
HLL90HLB	HLL90HLBP	12-24VDC High/low beam	1

High Beam: 12.8VDC - 23.68W / 28VDC - 22.4W

Low Beam: 12.8VDC - 23.04W / 28VDC - 22.4W

IP67 rating: protected from dust and capable of withstanding water immersion, offering increased reliability and service life

FMVSS	HL
MATERIALS	Polycarbonate lens, aluminum housing
VOLT/AMP	12.8VDC - High Beam 1.85A / Low Beam 1.80A
WT/DIMS	2.05 lbs. / 7" x 7" x 2.8"
WARRANTY	Three Year Warranty

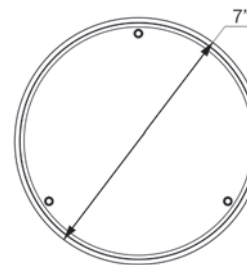



STL101 GROMMET MOUNT SERIES GloLight™ 4" Sealed LED Lights



STL101RB



STL101RCB



STL101AB



STL101ACB

- Sonically sealed, waterproof
- Mount in any 360 degree position
- Available in tinted and clear lens models
- Available with standard PL-3 or optional weathertight connection

BULK P/N	POLYPACK P/N	DESCRIPTION	QTY
----------	--------------	-------------	-----

RED STOP/TURN/TAIL LIGHT - 21 DIODES

STL101RB	STL101RBP	PL-3 connection	10
STL101RMB	STL101RMBP	Weathertight connection	10
STL101RCB	STL101RCBP	Clear lens, red diodes, PL-3	10
STL101RCMB	STL101RCMBP	Clear lens, red diodes, weathertight	10

YELLOW PARKING/TURN SIGNAL - 21 DIODES

STL101AB	STL101ABP	PL-3 connection	10
STL101ACB	STL101ACBP	Clear lens, yellow diodes, PL-3	10

ACCESSORIES

A45GB	A45GBP	Grommet	50
A45PB	A45PBP	Pigtail, 3-wire	100
A47PB	A47PBP	Right angle pigtail, 3-wire	100
A45PMB	A45PMBP	Weathertight pigtail	100
AL45PWTB	AL45PWTBP	Weathertight to PL-3 adaptor	50
BK45BB	BK45BBP	Black steel bracket	10
A45BB	A45BBP	Black plastic flange	100
A45SB	A45SBP	Stainless steel mounting flange	20
A45CGB	A45CGBP	Chrome grommet cover	20

FMVSS	Red S2 T2 I6; Yellow I6 P
MATERIALS	Polycarbonate lens and housing
VOLT/AMP	Red: 12.8VDC - .375A Stop/Turn, .145A Tail Yellow: 12.8VDC - .315A Turn, .143A Parking
WT/DIMS	.35 lbs. / 4.313" dia (PL-3: 2.188" D; Weathertight: 1.53" D)
WARRANTY	Lifetime LED Warranty



4 5/16"

Depth varies; see above for dimensions

HOLE CUT-OUT: 4.5"



STL101 FLANGE MOUNT SERIES GloLight™ 4" Sealed LED Lights with Mounting Flange

- Sonically sealed, waterproof
- Flange mount for security, theft reduction
- Available in tinted and clear lens models
- Available with standard PL-3 or optional weathertight connection

BULK P/N	POLYPACK P/N	DESCRIPTION	QTY
RED STOP/TURN/TAIL LIGHT - 21 DIODES			
STL101RFB	STL101RFBP	PL-3 connection	10
STL101RFMB	STL101RFMBP	Weathertight connection	10
STL101RCFB	STL101RCFBP	Clear lens, red diodes, PL-3	10
STL101RCFMB	STL101RCFMBP	Clear lens, red diodes, weathertight	10
ACCESSORIES			
A45PB	A45PBP	Pigtail, 3-wire	100
A47PB	A47PBP	Right angle pigtail, 3-wire	100
A45PMB	A45PMBP	Weathertight pigtail	100
AL45PWTB	AL45PWTBP	Weathertight to PL-3 adaptor	50
BK45BB	BK45BBP	Black steel bracket	10
A101TRSSB	A101TRSSBP	Stainless steel trim ring	50
A42GB	A42GBP	Mounting gasket, black	100

FMVSS	Red S2 T2 I6
MATERIALS	Polycarbonate lens and housing
VOLT/AMP	Red: 12.8VDC - .375 Stop/Turn, .145A Tail
WT/DIMS	.38 lbs. / 5.48" x 5.48" x 1.53"
WARRANTY	Lifetime LED Warranty

Industry-standard connections
Easy retrofit of lights to existing harness



Standard PL3 connection

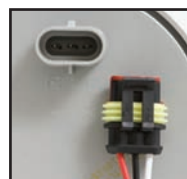

Weathertight connection

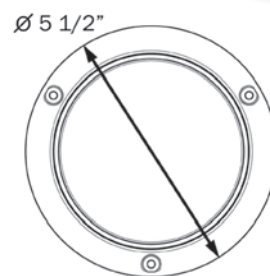
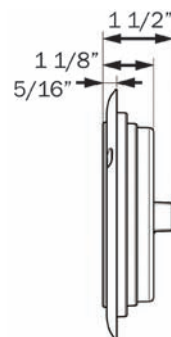

HOLE CUT-OUT: 4.5"

STOP/TURN

TAIL LIGHT



STL101RFB



STL101RCFB

SEALED STOP/TURN/TAIL & PARKING/TURN SIGNALS



STL43 SERIES 4" Round Sealed LED Lights

- Sonically sealed, waterproof
- Kits include grommet and plug
- Mount in any 360 degree position
- Available in 12V and 24V models
- Available with standard PL-3 or optional weathertight connection



STL43RB



STL53RCB



STL43AB

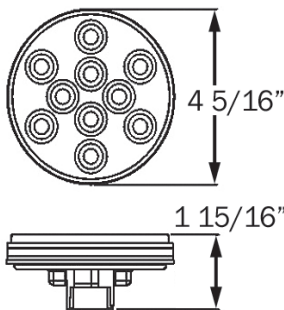

HOLE CUT-OUT: 4.5"

BULK P/N	POLYPACK P/N	DESCRIPTION	QTY
RED STOP/TURN/TAIL LIGHT - 10 DIODES			
STL43RB	STL43RBP	PL-3 connection, 12V	10
STL43RKB	STL43RKBP	Kit with A45GB & A47PB, PL-3, 12V	10
STL43R24B	STL43R24BP	PL-3 connection, 24V	10
STL43RMB	STL43RMBP	Weathertight connection, 12V	10
STL43RM24B	STL43RM24BP	Weathertight connection, 24V	10
STL53RCB	STL53RCBP	Clear lens, red diode, PL-3	10
YELLOW PARKING/TURN SIGNAL - 10 DIODES			
STL43AB	STL43ABP	PL-3 connection, 12V	10
STL43A24B	STL43A24BP	PL-3 connection, 24V	10
STL43AKB	STL43AKBP	Kit with A45GB & A47PB, PL-3, 12V	10
ACCESSORIES			
A45GB	A45GBP	Grommet	50
A45PB	A45PBP	Pigtail, 3-wire PL-3	100
A47PB	A47PBP	Right angle pigtail, 3-wire PL-3	100
A45PMB	A45PMBP	Weathertight pigtail	100
AL45PWTB	AL45PWTBP	Weathertight to PL-3 adaptor	50
BK45BB	BK45BBP	Black steel bracket	10
A45BB	A45BBP	Black plastic flange	100
A45SB	A45SBP	Stainless steel mounting flange	20
A45CGB	A45CGBP	Chrome grommet cover	20

RETAIL

STL43RK		12V kit with A45GB & A47PB, clam	6
---------	--	----------------------------------	---

FMVSS	Red S T I P2; Yellow I6 P
MATERIALS	Polycarbonate lens and housing
VOLT/AMP	Red: 12.8VDC - .360A Stop/Turn, .030A Tail Yellow: 12.8VDC - .310A Turn, .046A Parking
WT/DIMS	.265 lbs. / 4.313" x 4.313" x 1.938"
WARRANTY	Lifetime LED Warranty

STL42 SERIES 4" Round Sealed LED Lights with Mounting Flange

- Sonically sealed, waterproof
- Flange mount for security, theft reduction
- Red available with standard PL-3 or optional weathertight connection

BULK P/N	POLYPACK P/N	DESCRIPTION	QTY
RED STOP/TURN/TAIL LIGHT - 10 DIODES			
STL42RB	STL42RBP	Black flange, PL-3	10
STL42RMB	STL42RMBP	Black flange, weathertight	10
YELLOW PARKING/TURN SIGNAL - 10 DIODES			
STL42AB	STL42ABP	Black flange, PL-3	10
STL42AMB	STL42AMBP	Black flange, weathertight	10
ACCESSORIES			
A45PB	A45PBP	Pigtail, 3-wire PL-3	100
A47PB	A47PBP	Right angle pigtail, 3-wire PL-3	100
A45PMB	A45PMBP	Weathertight pigtail	100
AL45PWTB	AL45PWTBP	Weathertight to PL-3 adaptor	50
BK45BB	BK45BBP	Black steel bracket	10
A42FCB	A42FCBP	Chrome flange cover	100
A5TRSSB	A5TRSSBP	Stainless steel trim ring	100
A42GB	A42GBP	Mounting gasket, black	100

FMVSS	Red S T I P2; Yellow I6 P
MATERIALS	Polycarbonate lens and housing
VOLT/AMP	Red: 12.8VDC - .413 Stop/Turn, .026A Tail Yellow: 12.8VDC - .310 Turn, .046A Parking
WT/DIMS	.617 lbs. / 5.5" x 5.5" x 1.938"
WARRANTY	Lifetime LED Warranty



STL42RB



STL42AB

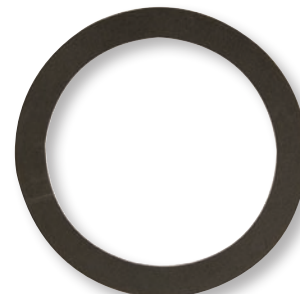

A42GB

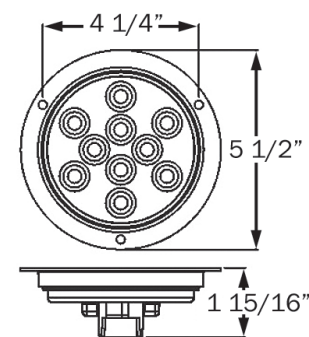

HOLE CUT-OUT: 4.5"



STL43 REFLEX FLANGE SERIES 4" Round Sealed LED Lights with Reflex Mounting Flange



STL43RBX



STL43ABX

- Sonically sealed, waterproof
- Flange mount for security, theft reduction
- Accepts standard PL-3 connector
- Reflex flange meets SAE A for reflector

BULK P/N	POLYPACK P/N	DESCRIPTION	QTY
RED STOP/TURN/TAIL LIGHT - 10 DIODES			
STL43RBX	STL43RBXP	Red reflex flange, gasket, PL-3	10
STL43RBHX	-	Red reflex flange, hard wire, gasket	10
YELLOW PARKING/TURN SIGNAL - 10 DIODES			
STL43ABX	STL43ABXP	Yellow reflex flange, gasket	10
ACCESSORIES			
A45PB	A45PBP	Pigtail, 3-wire PL-3	100
A47PB	A47PBP	Right angle pigtail, 3-wire PL-3	100

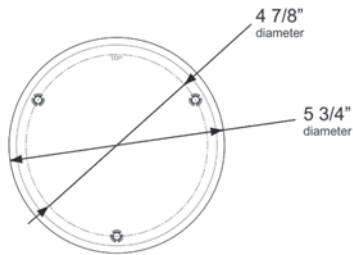

HOLE CUT-OUT: 4.5"

FMVSS	Red S T I; Yellow I6 P; Reflex A
MATERIALS	Polycarbonate lens and housing
VOLT/AMP	Red: 12.8VDC - .413 Stop/Turn, .026A Tail Yellow: 12.8VDC - .310 Turn, .046A Parking
WT/DIMS	.397 lbs. / 5.75" x 5.75" x 1.625"
WARRANTY	Lifetime LED Warranty

STL13 SERIES FLEET Count™ 4" Round Sealed LED Stop/Turn/Tail Lights

- Sonically sealed, waterproof
- Available in grommet and flange mount models
- Available with standard PL-3, male pin, weathertight or hard wired connections
- Retail kit includes grommet and plug



STL13RB



HOLE CUT-OUT: 4.5"

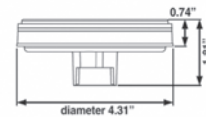

BULK P/N	POLYPACK P/N	DESCRIPTION	QTY
RED STOP/TURN/TAIL - 7 DIODES			
STL13RB	STL13RBP	PL-3 connection	10
STL13RMB	STL13RMBP	Weathertight connection	10
STL13RGB	STL13RGBP	Male pin connection	10
STL13RH1B	STL13RH1BP	Hard wired, PL-3 female plug	10
STL13RH3B	STL13RH3BP	Hard wired, .180 male bullets	10
STL13RFB	STL13RFBP	Flange, PL-3	10
STL13RFMB	STL13RFMBP	Flange, weathertight	10

ACCESSORIES

A45GB	A45GBP	Grommet	50
A45PB	A45PBP	Pigtail, 3-wire PL-3	100
A47PB	A47PBP	Right angle pigtail, 3-wire PL-3	100
A45PMB	A45PMBP	Weathertight pigtail	100
AL45PWTB	AL45PWTBP	Weathertight to PL-3 adaptor	50
BK45BB	BK45BBP	Black steel bracket	10
A45BB	A45BBP	Black plastic flange	100
A45SB	A45SBP	Stainless steel flange	20
A42FCB	A42FCBP	Chrome flange cover	100
A5TRSSB	A5TRSSBP	Stainless steel trim ring	100
A45CGB	A45CGBP	Chrome grommet cover	20

RETAIL

STL13RK		Kit with A45GB & A47PB, clam	6
STL13RS		Light only, clam	6

FMVSS	STI
MATERIALS	Polycarbonate lens and housing
VOLT/AMP	12.8VDC - .234A Stop/Turn, .033A Tail
WT/DIMS	STL13 grommet mount: .265 lbs. / 4.31" x 4.31" x 1.81" STL13 flange mount: .275 lbs. / 5.5" x 5.5" x 1.938"
WARRANTY	Lifetime LED Warranty



STL13RFB

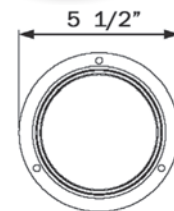

HOLE CUT-OUT: 4.5"

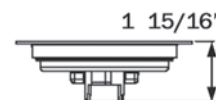

STL13RGB male pin connection





STL23 SERIES Miro-Flex™ 4" Round Sealed LED Lights

- Sonically sealed, waterproof
- Mount in any 360 degree position
- Accepts standard PL-3 plugs
- Available in 12V and 24V models



STL23RB



STL23CCRB



STL23AB

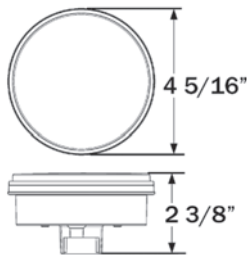

HOLE CUT-OUT: 4.5"

BULK P/N	POLYPACK P/N	DESCRIPTION	QTY
RED STOP/TURN/TAIL - 12 DIODES			
STL23RB	STL23RBP	PL-3 connection, 12V	10
STL23CCRB	STL23CCRBP	Clear lens, red reflector, PL-3, 12V	10
STL23R24B	STL23R24BP	PL-3 connection, 24V	10
YELLOW PARKING/TURN SIGNAL - 16 DIODES			
STL23AB	STL23ABP	PL-3 connection, 12V	10
STL23A24B	STL23A24BP	PL-3 connection, 24V	10
ACCESSORIES			
A45GB	A45GBP	Grommet	50
A45PB	A45PBP	Pigtail, 3-wire PL-3	100
A47PB	A47PBP	Right angle pigtail, 3-wire PL-3	100
BK45BB	BK45BBP	Black steel bracket	10
A45BB	A45BBP	Black plastic flange	100
A45SB	A45SBP	Stainless steel flange	20
A45CGB	A45CGBP	Chrome grommet cover	20

FMVSS	Red S T I; Yellow I P
MATERIALS	Polycarbonate lens and housing
VOLT/AMP	Red: 12.8VDC - .208 Stop/Turn, .013A Tail 24.0VDC - .171 Stop/Turn, .061A Tail Yellow: 12.8VDC - .310 Turn, .046A Parking 24.0VDC - .171 Stop/Turn, .061A Tail
WT/DIMS	.265 lbs. / 4.313" x 4.313" x 1.938"
WARRANTY	Lifetime LED Warranty

STL543 SERIES

HyperX® 4" Round Sealed LED Stop/Turn/Tail Light

- Sonically sealed, waterproof
- Mount in any 360 degree position
- Accepts standard PL-3 plugs
- 12 diodes and contemporary, automotive style optics

HYPERX

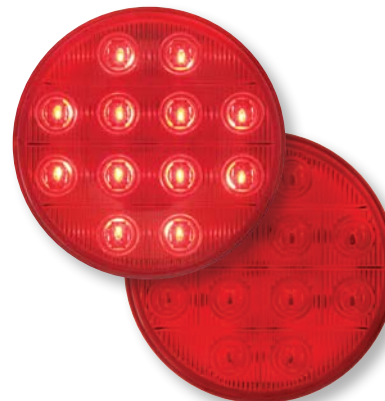

STL543RB

BULK P/N	POLYPACK P/N	DESCRIPTION	QTY
RED STOP/TURN/TAIL - 12 DIODES			
STL543RB	STL543RBP	PL-3 connection	10
ACCESSORIES			
A45GB	A45GBP	Grommet	50
A45PB	A45PBP	Pigtail, 3-wire PL-3	100
A47PB	A47PBP	Right angle pigtail, 3-wire PL-3	100
BK45BB	BK45BBP	Black steel bracket	10
A45BB	A45BBP	Black plastic flange	100
A45SB	A45SBP	Stainless steel flange	20
A45CGB	A45CGBP	Chrome grommet cover	20

FMVSS	S T I
MATERIALS	Polycarbonate lens and housing
VOLT/AMP	12.8VDC - .208 Stop/Turn, .013A Tail
WT/DIMS	.265 lbs. / 4.313" x 4.313" x 1.938"
WARRANTY	Lifetime LED Warranty

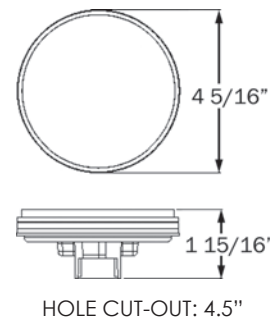

SEALED STOP/TURN/TAIL & PARKING/TURN SIGNALS



STL55 SERIES High LED Count 4" Round Sealed Lights for Recess Mount



STL55RB

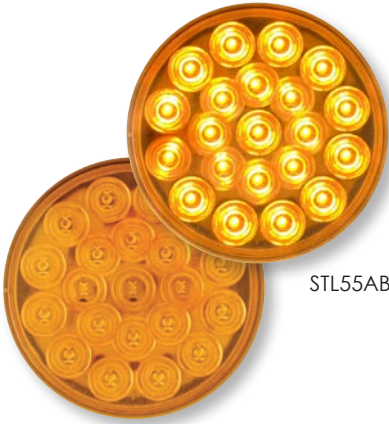

STL55AB

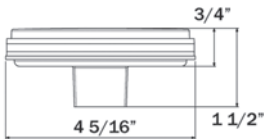

HOLE CUT-OUT: 4.5"

- Sonically sealed, waterproof
- 21 LEDs for high diode count appearance
- Mount in any 360 degree position
- Accepts standard PL-3 plugs; red available with optional weathertight connection



BULK P/N	POLYPACK P/N	DESCRIPTION	QTY
RED STOP/TURN/TAIL - 21 DIODES			
STL55RB	STL55RBP	PL-3 connection	10
STL55RFMB	STL55RFMBP	Weathertight connection	10
YELLOW PARKING/TURN SIGNAL - 21 DIODES			
STL55AB	STL55ABP	PL-3 connection	10
ACCESSORIES			
A45GB	A45GBP	Grommet	50
A45PB	A45PBP	Pigtail, 3-wire PL-3	100
A47PB	A47PBP	Right angle pigtail, 3-wire PL-3	100
A45PMB	A45PMBP	Weathertight pigtail	100
AL45PWTB	AL45PWTBP	Weathertight to PL-3 adaptor	50
BK45BB	BK45BBP	Black steel bracket	10
A45BB	A45BBP	Black plastic flange	100
A45SB	A45SBP	Stainless steel flange	20
A45CGB	A45CGBP	Chrome grommet cover	20

FMVSS	Red S T I; Yellow I6 P
MATERIALS	Polycarbonate lens and housing
VOLT/AMP	Red: 12.8VDC - .208 Stop/Turn, .013A Tail Yellow: 12.8VDC - .310 Turn, .046A Parking
WT/DIMS	.265 lbs. / 4.313" x 4.313" x 1.938"
WARRANTY	Lifetime LED Warranty

STL111 GROMMET MOUNT SERIES GloLight™ 6" Sealed LED Lights

- Sonically sealed, waterproof
- Mount in any 360 degree position
- Available in tinted and clear lens models
- Available with standard PL-3 or optional weathertight connection



SEALED STOP/TURN/TAIL & PARKING/TURN SIGNALS

BULK P/N	POLYPACK P/N	DESCRIPTION	QTY
RED STOP/TURN/TAIL LIGHT - 22 DIODES			
STL111RB	STL111RBP	PL-3	10
STL111RMB	STL111RMBP	Weathertight	10
STL111RHB	STL111RHBP	Hard wired	10
STL111RCB	STL111RCBP	Clear lens, red diodes, PL-3	10
STL111RCMB	STL111RCMBP	Clear lens, red diodes, weathertight	10
YELLOW PARKING/TURN SIGNAL - 22 DIODES			
STL111AB	STL111ABP	PL-3	10
STL111ACB	STL111ACBP	Clear lens, yellow diodes, PL-3	10
ACCESSORIES			
A70GB	A70GBP	Grommet	50
A45PB	A45PBP	Pigtail, 3-wire	100
A47PB	A47PBP	Right angle pigtail, 3-wire	100
A45PMB	A45PMBP	Weathertight pigtail	100
AL45PWTB	AL45PWTBP	Weathertight to PL-3 adaptor	50
BK70BB	BK70BBP	Black steel bracket	10
A77SB	A77SBP	Gray steel bracket	20

RETAIL			
TLL112RK		Try Me kit with (2) ea. STL111RB, A70GB and A47PB, clam	2

FMVSS	Red S2 T2 I6; Yellow I6 P
MATERIALS	Polycarbonate lens and housing
VOLT/AMP	Red: 12.8VDC - .59A Stop/Turn, .295A Tail Yellow: 12.8VDC - .515A Turn, .27A Parking
WT/DIMS	.35 lbs. / 6.5" x 2.25" x 1.75"
WARRANTY	Lifetime LED Warranty

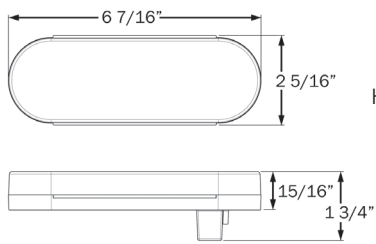
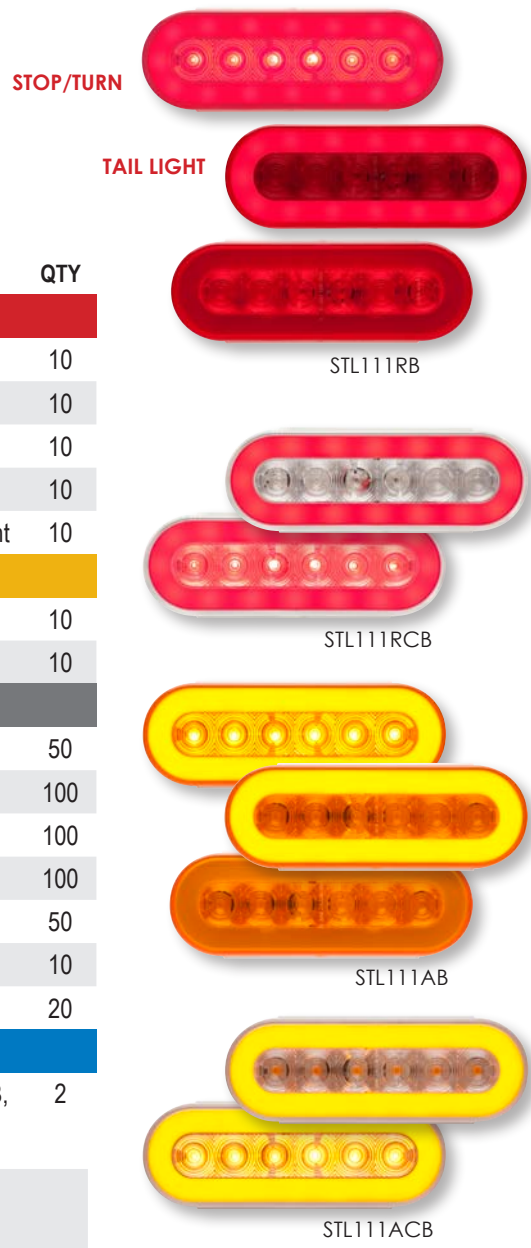

HOLE CUT-OUT:
6.85" X 2.5"
(1.25" R)



TLL112RK



STL111 FLANGE MOUNT SERIES GloLight™ 6" Sealed LED Lights with Mounting Flange



TAIL
LIGHT



STOP/
TURN

STL111RFB



STL111RCFB



- Sonically sealed, waterproof
- Recess flange mount for security, theft reduction
- Available in tinted and clear lens models
- Available with standard PL-3 or optional weathertight connection

BULK P/N	POLYPACK P/N	DESCRIPTION	QTY
RED STOP/TURN/TAIL LIGHT - 22 DIODES			
STL111RFB	STL111RFBP	PL-3 connection	10
STL111RFMB	STL111RFMBP	Weathertight connection	10
STL111RCFB	STL111RCFBP	Clear lens, red diodes, PL-3	10
STL111RCFMB	STL111RCFMBP	Clear lens, red diodes, weathertight	10
ACCESSORIES			
A45PB	A45PBP	Pigtail, 3-wire	100
A47PB	A47PBP	Right angle pigtail, 3-wire	100
A45PMB	A45PMBP	Weathertight pigtail	100
AL45PWTB	AL45PWTBP	Weathertight to PL-3 adaptor	50
BK70BB	BK70BBP	Black steel bracket	10
A77SB	A77SBP	Gray steel bracket	20
A111TRSSB	A111TRSSBP	Stainless steel trim ring	50

FMVSS	Red S2 T2 I6
MATERIALS	Polycarbonate lens and housing
VOLT/AMP	12.8VDC - .59 Stop/Turn, .295A Tail
WT/DIMS	.38 lbs. / 7.5" x 3.3" x 1.938"
WARRANTY	Lifetime LED Warranty

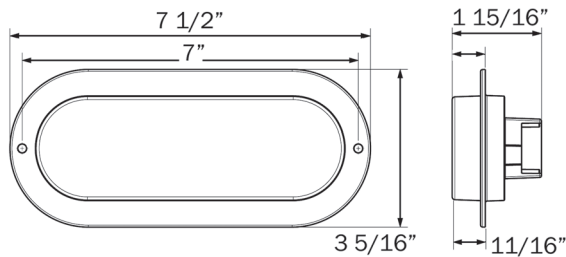

HOLE CUT-OUT: 6.85" X 2.5" (1.25" R)

STL178 SERIES

GloLight™ 6" Sealed LED Stop/Turn/Tail Lights for Surface Mount

- Sonically sealed, waterproof
- Mount in any 360 degree position
- Flange surface mount–no panel cut-out required
- Hard wired, with optional molded connectors
- Available in tinted and clear lens models

BULK P/N	POLYPACK P/N	DESCRIPTION	QTY
RED STOP/TURN/TAIL LIGHT - 22 DIODES			
STL178RB	STL178RBP	Hard wired	10
STL178RFPB	STL178RFPBP	Hard wired, female PL-3 plug	10
STL178RCB	STL178RCBP	Clear lens, red diodes, hard wired	10
ACCESSORIES			
BK70BB	BK70BBP	Black steel bracket	10
A77SB	A77SBP	Gray steel bracket	20
A178TRSSB	A178TRSSBP	Stainless steel trim ring	50

FMVSS	Red S2 T2 I6
MATERIALS	Polycarbonate lens and housing
VOLT/AMP	12.8VDC - .59 Stop/Turn, .295A Tail
WT/DIMS	.38 lbs. / 7.5" x 3.3" x 1.1"
WARRANTY	Lifetime LED Warranty



TAIL LIGHT



STOP/TURN



STL178RB



STL178RCB

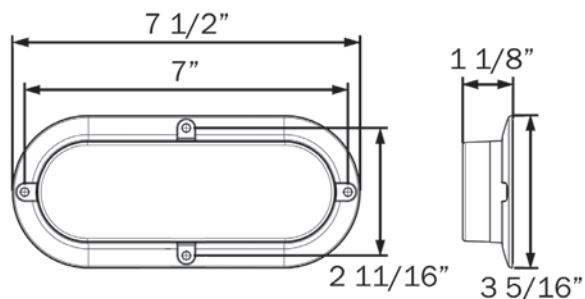

SEALED STOP/TURN/TAIL & PARKING/TURN SIGNALS



STL72/82 SERIES 6" Oval Sealed LED Lights

- Sonically sealed, waterproof
- Kits include grommet and plug
- Mount in any 360 degree position
- Available with standard PL-3 or optional weathertight connection



STL72RB

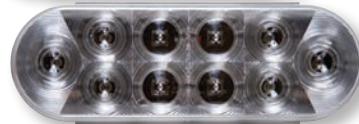
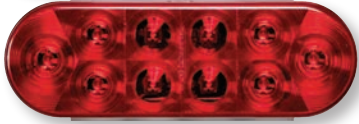

STL82RCB



STL72AB



STL72CAB

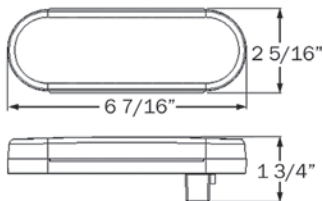

HOLE CUT-OUT: 6.85" X 2.5" (1.25" R)

BULK P/N	POLYPACK P/N	DESCRIPTION	QTY
RED STOP/TURN/TAIL LIGHT - 10 DIODES			
STL72RB	STL72RBP	PL-3 connection	10
STL72RKB	STL72RKBP	Kit with A70GB, PL-3	10
STL74RBK	STL74RBKP	Kit with A70GB & A47PB, PL-3	50
STL74RKB	STL74RKBP	Kit with A70GB & A45PB, PL-3	10
STL72RMB	STL72RMBP	Weathertight connection	10
STL82RCB	STL82RCBP	Clear lens, red diodes, PL-3	10
YELLOW PARKING/TURN SIGNAL - 10 DIODES			
STL72AB	STL72ABP	PL-3	10
STL72AMB	STL72AMPB	Weathertight connection	10
STL72CAB	STL72CABP	Clear lens, amber diodes, PL-3	10
ACCESSORIES			
A70GB	A70GBP	Grommet	50
A45PB	A45PBP	Pigtail, 3-wire PL-3	100
A47PB	A47PBP	Right angle pigtail, 3-wire PL-3	100
A45PMB	A45PMBP	Weathertight pigtail	100
AL45PWTB	AL45PWTBP	Weathertight to PL-3 adaptor	50
BK70BB	BK70BBP	Black steel bracket	10
A77SB	A77SBP	Gray steel bracket	20
RETAIL			
STL72RK		12V kit with A70GB & A47PB, clam	6
STL72RS		12V, clam	6

FMVSS	Red I6 P3 S2 T2; Yellow I6 P
MATERIALS	Polycarbonate lens and housing
VOLT/AMP	Red: 12.8VDC - .243A Stop/Turn, .046A Tail Yellow: 12.8VDC - .275A Turn, .042A Parking
WT/DIMS	.309 lbs. / 6.438" x 2.313" x 1.75"
WARRANTY	Lifetime LED Warranty

STL78/88 SERIES

6" Oval Sealed LED Lights for Surface Mount

- Sonically sealed, waterproof
- Mount in any 360 degree position
- Flange surface mount—no panel cut-out required
- Hard wired, with optional molded connectors

BULK P/N	POLYPACK P/N	DESCRIPTION	QTY
RED STOP/TURN/TAIL LIGHT - 10 DIODES			
STL78RB	STL78RBP	Hard wired	10
STL78RPG	STL78RPGP	.180 male bullets	10
STL78REZB	STL78REZBP	3-way female PL-3 plug	10
STL88RCB	STL88RCBP	Clear lens, red diodes, hard wired	10
STL88RCPG	STL88RCPGP	Clear lens, red diodes, 3-way female PL-3 plug	10
YELLOW PARKING/TURN SIGNAL - 10 DIODES			
STL78AB	STL78ABP	Hard wired	10
ACCESSORIES			
A78CB1	A78CB1P	Chrome flange cover	25
A78RXB	A78RXBP	Red reflex flange cover & gasket	25
RETAIL			
STL78RK		Single light, clam	6

FMVSS	Red I6 P3 S2 T2; Yellow I6 P
MATERIALS	Polycarbonate lens and housing
VOLT/AMP	Red: 12.8VDC - .243A Stop/Turn, .046A Tail Yellow: 12.8VDC - .275A Turn, .042A Parking
WT/DIMS	.265 lbs. / 7.563" x 3.313" x 0.750"
WARRANTY	Lifetime LED Warranty



STL78RB

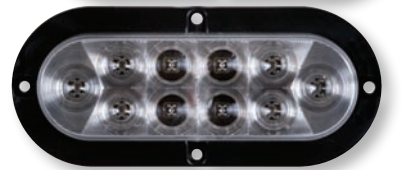

STL88RCB

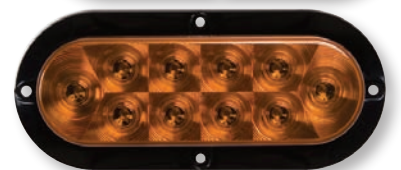

STL78AB

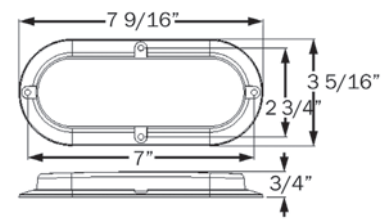

SEALED STOP/TURN/TAIL & PARKING/TURN SIGNALS



STL12RB

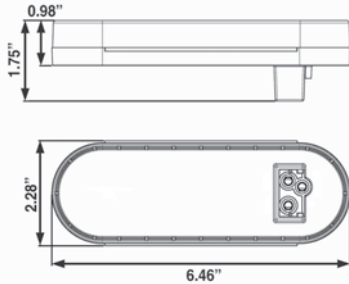

HOLE CUT-OUT: 6.85" X 2.5" (1.25" R)



STL73RB

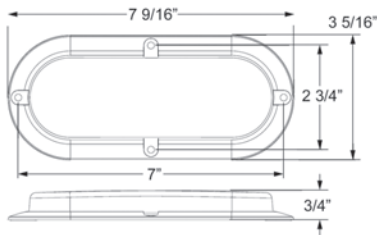

TLL12RK

STL12 SERIES FLEET Count™ 6" Oval Sealed LED Stop/Turn/Tail Lights

- Sonically sealed, waterproof
- Available in grommet and flange mount models
- Grommet mount model available with standard PL-3 or optional weathertight connection
- Flange surface mount model hard wired requiring no panel cut-out; includes ground
- Retail kit includes light, grommet and plug

BULK P/N	POLYPACK P/N	DESCRIPTION	QTY
RED STOP/TURN/TAILO - 6 DIODES			
STL12RB	STL12RBP	PL-3 connection	10
STL12RMB	STL12RMBP	Weathertight connection	10
STL73RB	STL73RBP	Flange surface mount, hard wired	10
ACCESSORIES			
A70GB	A70GBP	Grommet	50
A45PB	A45PBP	Pigtail, 3-wire PL-3	100
A47PB	A47PBP	Right angle pigtail, 3-wire PL-3	100
A45PMB	A45PMBP	Weathertight pigtail	100
AL45PWTB	AL45PWTBP	Weathertight to PL-3 adaptor	50
BK70BB	BK70BBP	Black steel bracket for STL12RB	10
A77SB	A77SBP	Gray steel bracket for STL12RB	20
A78CB1	A78CB1P	Chrome flange cover	25
RETAIL			
STL12RK		Kit with A70GB & A47PB, clam	6
STL12RS		Light only, clam	6
TLL12RK		Kit with (2) each STL12RB, A70GB & A47PB, clam	2

FMVSS	S T I
MATERIALS	Polycarbonate lens and housing
VOLT/AMP	12.8VDC - .161A Stop/Turn, .007A Tail
WT/DIMS	STL12RB: .375 lbs. / 6.5" x 2.25" x 1.75"
	STL12RMB: .375 lbs. / 6.5" x 2.25" x 1.75"
	STL73RB: .287 lbs. / 7.563" x 3.313" x 0.75"
WARRANTY	Lifetime LED Warranty

STL22 SERIES

Miro-Flex™ 6" Oval Sealed LED Lights

- Sonically sealed, waterproof
- Mount in any 360 degree position
- Accepts standard PL-3 plugs
- Available with tinted or clear lens and chrome or tinted reflector

BULK P/N	POLYPACK P/N	DESCRIPTION	QTY
RED STOP/TURN/TAIL - 12 DIODES			
STL22RB	STL22RBP	PL-3 connection	10
STL22RBH	STL22RBHP	Hard wired	10
STL22CCRB	STL22CCRBP	Clear lens, red reflector, PL-3	10
STL22RCB	STL22RCBP	Clear lens, PL-3	10
YELLOW PARKING/TURN SIGNAL - 16 DIODES			
STL22AB	STL22ABP	PL-3 connection	10
STL22CCAB	STL22CCABP	Clear lens, yellow reflector, PL-3	10
ACCESSORIES			
A70GB	A70GBP	Grommet	50
A45PB	A45PBP	Pigtail, 3-wire PL-3	100
A47PB	A47PBP	Right angle pigtail, 3-wire PL-3	100
AL45PWTB	AL45PWTBP	Weathertight pigtail	50
BK70BB	BK70BBP	Black steel bracket	10
A77SB	A77SBP	Gray steel bracket	20
RETAIL			
TLL22RK		Kit with (2) each STL22RCB, A70GB & A47PB, clam	2

FMVSS	Red S T I; Yellow I P
MATERIALS	Polycarbonate lens and housing
VOLT/AMP	Red: 12.8VDC - .161 Stop/Turn, .009A Tail Yellow: 12.8VDC - .181 Turn, .023A Parking
WT/DIMS	.397 lbs. / 6.5" x 2.313" x 2.188"
WARRANTY	Lifetime LED Warranty

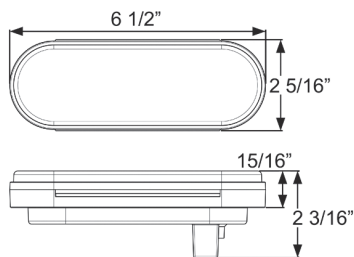

HOLE CUT-OUT:
6.85" X 2.5" (1.25" R)



TLL22RK



STL22RB



STL22CCRB



STL22RCB



STL22AB



STL22CCAB



STL572 SERIES HyperX® 6" Oval Sealed LED Lights

- Sonically sealed, waterproof
- Mount in any 360 degree position
- Accepts standard PL-3 plugs
- 12 diodes with contemporary, automotive style optics



STL572RB



STL572AB

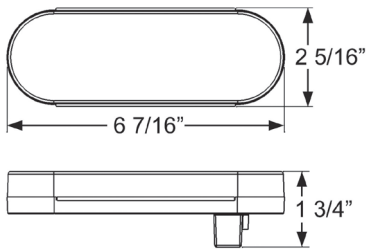

HOLE CUT-OUT: 6.85" X 2.5" (1.25" R)

BULK P/N	POLYPACK P/N	DESCRIPTION	QTY
RED STOP/TURN/TAIL - 12 DIODES			
STL572RB	STL572RBP	PL-3 connection	10
YELLOW PARKING/TURN SIGNAL - 12 DIODES			
STL572AB	STL572ABP	PL-3 connection	10
ACCESSORIES			
A70GB	A70GBP	Grommet	50
A45PB	A45PBP	Pigtail, 3-wire PL-3	100
A47PB	A47PBP	Right angle pigtail, 3-wire PL-3	100
BK70BB	BK70BBP	Black steel bracket	10
A77SB	A77SBP	Gray steel bracket	20

FMVSS	Red S T I; Yellow I P
MATERIALS	Polycarbonate lens and housing
VOLT/AMP	Red: 12.8VDC - .174 Stop/Turn, .007A Tail Yellow: 12.8VDC - .261 Turn, .013A Parking
WT/DIMS	.331 lb. / 6.438" x 2.313" x 1.75"
WARRANTY	Lifetime LED Warranty

STL70 SERIES

High Diode Count 6" Oval Sealed LED Lights

- Sonically sealed, waterproof
- 48-56 LEDs for high diode count appearance
- Mount in any 360 degree position
- Accepts standard PL-3 plugs



BULK P/N	POLYPACK P/N	DESCRIPTION	QTY
RED STOP/TURN/TAIL - 48 DIODES			
STL70RB	STL70RBP	PL-3 connection	10
YELLOW PARKING/TURN SIGNAL - 56 DIODES			
STL70AB	STL70ABP	PL-3 connection	10
ACCESSORIES			
A70GB	A70GBP	Grommet	50
A45PB	A45PBP	Pigtail, 3-wire PL-3	100
A47PB	A47PBP	Right angle pigtail, 3-wire PL-3	100
BK70BB	BK70BBP	Black steel bracket	10
A77SB	A77SBP	Gray steel bracket	20

FMVSS	Red S T I P2; Yellow I P2 P
MATERIALS	Polycarbonate lens and housing
VOLT/AMP	Red: 12.8VDC - .362 Stop/Turn, .013A Tail Yellow: 12.8VDC - .400 Turn, .046A Parking
WT/DIMS	.353 lbs. / 6.5" x 2.25" x 1.125"
WARRANTY	Lifetime LED Warranty



STL70RB



STL70AB

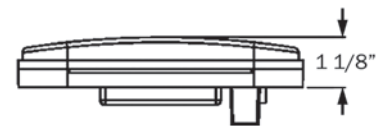
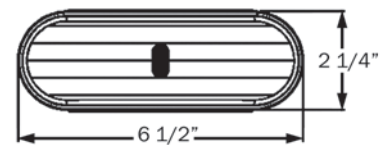

HOLE CUT-OUT: 6.85" X 2.5" (1.25" R)



STL71/75 SERIES 6" Oval Sealed LED E Rated Mid-Ship Turn Signal and Intermediate Marker Light

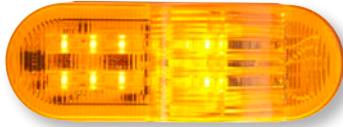

STL71AMB

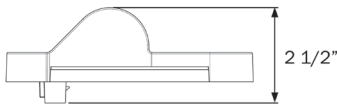
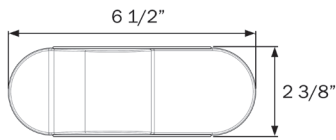

HOLE CUT-OUT: 6.85" X 2.5" (1.25" R)



STL75AMFB

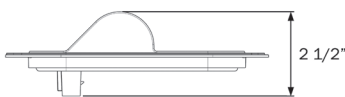
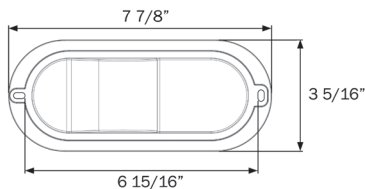

HOLE CUT-OUT: 6.85" X 2.5" (1.25" R)

- Sonically sealed, waterproof
- SAE "E" compliant—meets California requirements for mid-ship turn signal on vehicles 30 feet or longer
- Weathertight connection standard

BULK P/N	POLYPACK P/N	DESCRIPTION	QTY
E RATED - 10 DIODES			
STL71AMB	STL71AMBP	Weathertight connection	10
STL75AMFB	STL75AMFBP	Flange, weathertight connection	10
ACCESSORIES			
A70GB	A70GBP	Grommet	50
A45PB	A45PBP	Pigtail, 3-wire PL-3	100
A47PB	A47PBP	Right angle pigtail, 3-wire PL-3	100
A45PMB	A45PMBP	Weathertight pigtail	100
AL45PWTB	AL45PWTBP	Weathertight to PL-3 adaptor	50
BK70BB	BK70BBP	Black steel bracket	10
A77SB	A77SBP	Gray steel bracket	20
A7TRSSB	A7TRSSBP	Stainless steel flange cover	20

FMVSS E P2

MATERIALS Polycarbonate lens and housing

VOLT/AMP 12.8VDC - .201A Turn, .054 Marker

WT/DIMS Grommet Mount: .309 lbs. / 6.5" x 2.375" x 2.5"
Flange Mount: .309 lbs. / 7.875" x 3.313" x 2.5"

WARRANTY Lifetime LED Warranty

STL75 SERIES

**6" Oval Sealed LED
E2 Rated Mid-Ship Turn Signal
and Intermediate Marker Light**

- Sonically sealed, waterproof
- "E2" rated for vehicles less than 30 feet in length
- Available with standard PL-3 or optional weathertight connection



STL75AB

BULK P/N	POLYPACK P/N	DESCRIPTION	QTY
E2 RATED - 9 DIODES			
STL75AB	STL75ABP	PL-3 connection	10
STL75AMB	STL75AMP	Weathertight connection	10
STL75HA1B	STL75HA1BP	Hard wired, weathertight connection	10
ACCESSORIES			
A70GB	A70GBP	Grommet	50
A45PB	A45PBP	Pigtail, 3-wire PL-3	100
A47PB	A47PBP	Right angle pigtail, 3-wire PL-3	100
A45PMB	A45PMBP	Weathertight pigtail	100
AL45PWTB	AL45PWTBP	Weathertight to PL-3 adaptor	50
BK70BB	BK70BBP	Black steel bracket	10
A77SB	A77SBP	Gray steel bracket	20

FMVSS	A E2 P2
MATERIALS	Polycarbonate lens and housing
VOLT/AMP	12.8VDC - .141A Turn, .060 Marker
WT/DIMS	PL-3 Connection: .309 lbs. / 6.5" x 2.313" x 2.75" Weathertight: .309 lbs. / 6.5" x 2.313" x 2.58"
WARRANTY	Lifetime LED Warranty

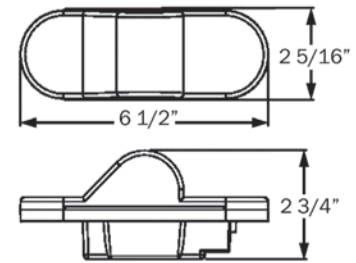

HOLE CUT-OUT: 6.85" X 2.5" (1.25" R)

SEALED STOP/TURN/TAIL &
PARKING/TURN SIGNALS



STL33 SERIES Sealed Rectangular LED Stop/Turn/Tail Lights

- Sonically sealed, waterproof
- Accepts standard PL-3 plugs
- Available in grommet mount and flange mount models
- Flange mount model is hard wired, with female PL-3 plug



STL33RB



STL33RB

BULK P/N	POLYPACK P/N	DESCRIPTION	QTY
RED STOP/TURN/TAIL - 12 DIODES			
STL33RB	STL33RBP	Grommet mount, PL-3 connection	10
STL34RB	STL34RBP	Kit: STL33RB, A33GB & A45PB	10
STL33RFB	STL33RFBP	Flange mount, hard wired, PL-3 plug	10
ACCESSORIES			
A33GB	A33GBP	Grommet	50
A45PB	A45PBP	Pigtail, 3-wire PL-3	100
A47PB	A47PBP	Right angle pigtail, 3-wire PL-3	100

FMVSS	S2 T2 I6
MATERIALS	Polycarbonate lens and housing
VOLT/AMP	12.8VDC - .405 Stop/Turn, .038A Tail
WT/DIMS	STL33RB: .309 lbs. / 5.313" x 3.438" x 1.938" STL33RFB: .287 lbs. / 6.125" x 4.25" x .875"
WARRANTY	Lifetime LED Warranty

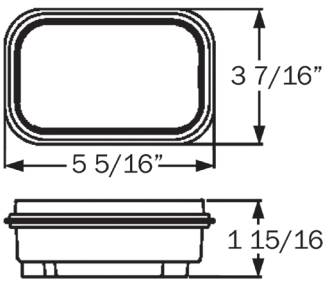

STL33RB

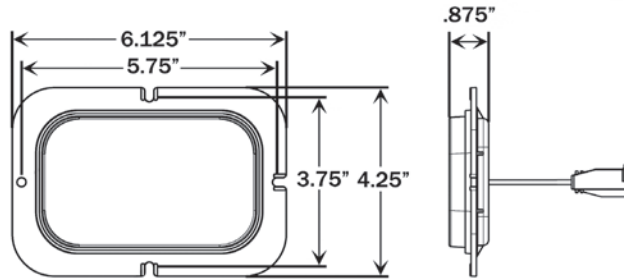

STL33RFB

HOLE CUT-OUT: 5.453" X 3.578" (1" R)

STL35 SERIES Sealed Rectangular LED Lights

- Sonically sealed, waterproof
- Accepts standard PL-3 plugs
- Available in red and amber
- Miro-Flex™ combines smooth lens and faceted reflector design for a contemporary automotive appearance

BULK P/N	POLYPACK P/N	DESCRIPTION	QTY
RED STOP/TURN/TAIL - 16 DIODES			
STL35RB	STL35RBP	PL-3 connection	10
YELLOW PARKING/TURN SIGNAL - 16 DIODES			
STL35AB	STL35ABP	PL-3 connection	10
ACCESSORIES			
A33GB	A33GBP	Grommet	50
A45PB	A45PBP	Pigtail, 3-wire PL-3	100
A47PB	A47PBP	Right angle pigtail, 3-wire PL-3	100

FMVSS	STL35RB: S2 T2 I6 STL35AB: I6 P
MATERIALS	Polycarbonate lens and housing
VOLT/AMP	STL35RB: 12.8VDC - .301 Stop/Turn, .020A Tail STL35AB: 12.8VDC - .301 Turn, .020A Parking
WT/DIMS	.309 lbs. / 5.313" x 3.438" x 2.313"
WARRANTY	Lifetime LED Warranty



STL35RB



STL35AB

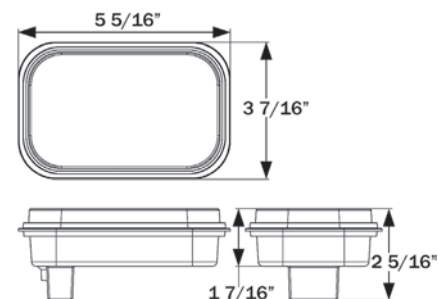

HOLE CUT-OUT: 5.453" X 3.578" (1" R)

SEALED STOP/TURN/TAIL & PARKING/TURN SIGNALS



STL63 SERIES Thinline LED Stop/Turn/Tail Lights



STL63RB

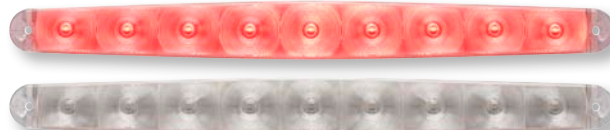

STL63CRB

- Sonically sealed, waterproof
- Low profile design—only 5/8" thick
- Surface mount on 14-1/8" centers
- Hard wired with separate ground wire
- Available with tinted or clear lens

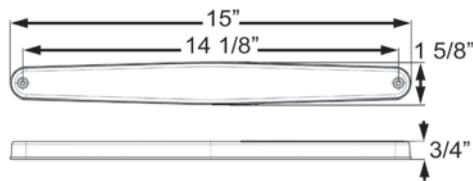

BULK P/N	POLYPACK P/N	DESCRIPTION	QTY
RED STOP/TURN/TAIL LIGHTS - 9 DIODES			
STL63RB	-	Red	10
STL63CRB	-	Clear lens, red diodes	10

FMVSS	S T I
MATERIALS	Polycarbonate lens and housing
VOLT/AMP	12.8VDC - .350 Stop/Turn, .022A Tail
WT/DIMS	.275 lbs. / 15" x 1" x .59"
WARRANTY	Lifetime LED Warranty



STL68 SERIES Surface Mount LED Combination Stop/Turn/Tail & Back-Up Light



STL68RB

- Sonically sealed, waterproof
- Low profile design—only 1/2" thick
- Surface mount on 9-11/16" centers
- Hard wired with separate ground wire

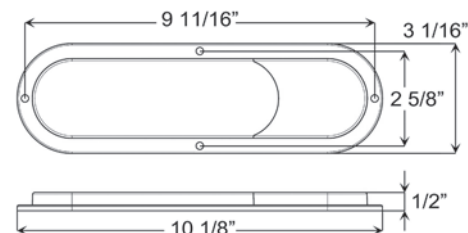

BULK P/N	POLYPACK P/N	DESCRIPTION	QTY
STOP/TURN/TAIL/BACK-UP LIGHT - 14 DIODES			
STL68RB	STL68RBP	Red	10

FMVSS	S T I R(2)
MATERIALS	Polycarbonate lens and housing
VOLT/AMP	12.8VDC - .35A Stop/Turn, .05A Tail, .3A Back-up
WT/DIMS	.275 lbs. / 15" x 1" x .59"
WARRANTY	Lifetime LED Warranty

STL69 SERIES

Thinline Sealed LED Stop/Turn/Tail Lights



- Sonically sealed, waterproof
- Low profile design—only 5/8" thick
- Surface mount on 14-1/8" centers; optional gasket
- STL69RRXB meets SAE S2T2I6 for over 80" wide vehicles and has built-in reflex meeting SAE A
- Hard wired with separate ground wire; available with optional molded plugs



BULK P/N	POLYPACK P/N	DESCRIPTION	QTY
RED STOP/TURN/TAIL LIGHTS - 11 DIODES			
STL69RB	STL69RBP	Red	10
STL69RCB	STL69RCBP	Clear lens, red diodes	10
STL69CRPG	-	Clear lens, red diodes, .180 male bullets	10
STL69RCBMCVB	-	Clear lens, red diodes, .156 female barrels, A69CB base	10
STL69RRXB	STL69RRXBP	Built-in reflex	10
STL69RRXBPG	-	Built-in reflex, .156 female barrels	10
ACCESSORIES			
A69GB	-	Gasket	10
A69CB	A69CBP	Chrome base for STL69	10
A69XCB	A69XCBP	Chrome base for STL69RRXB	10
FMVSS	STL69:	S T I	
	STL69RRXB:	S2 T2 I6 A	
MATERIALS	Polycarbonate lens and housing		
VOLT/AMP	STL69:	.350A Stop, .022 Tail	
	STL69RRXB:	.161A Stop, .013A Tail	
WT/DIMS	STL69:	.441 lbs. / 15" x 1.375" x .625"	
	STL69RRXB:	.445 lbs. / 15" x 1.625" x .625"	
WARRANTY	Lifetime LED Warranty		



LED COMBINATION
TAIL LIGHTS & KITS



STL179 SERIES GloLight™ Streamline LED Light

- Sonically sealed, waterproof
- Low profile design—only 1-3/8" high x 1" thick
- Surface mount on 16-1/8" centers
- Hard wired with separate ground wire



STL179RB

BULK P/N	POLYPACK P/N	DESCRIPTION	QTY
RED STOP/TURN/TAIL - 28 DIODES			
STL179RB	-	Stop/turn/tail light	10
ACCESSORIES			
A79CB	A79CBP	Chrome mounting base	10

FMVSS	S T I
MATERIALS	Polycarbonate lens and housing
VOLT/AMP	12.8VDC - .634 Stop/Turn, .445A Tail
WT/DIMS	.353 lbs. / 17" x 1.375" x 1"
WARRANTY	Lifetime LED Warranty

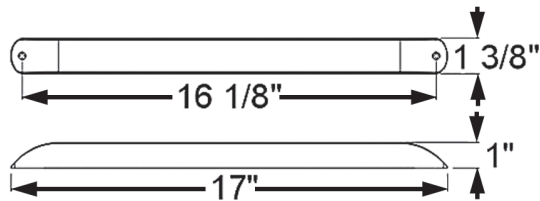

STL79 SERIES Streamline Sealed LED Lights



- Sonically sealed, waterproof
- Low profile design—only 1-3/8" high x 1" thick
- Surface mount on 16-1/8" centers
- Available as stop/turn/tail lights and third brake lights
- Hard wired with separate ground wire



STL79RB/80RB



STL89RCB

BULK P/N	POLYPACK P/N	DESCRIPTION	QTY
RED STOP/TURN/TAIL - 11 DIODES			
STL79RB	STL79RBP	Stop/turn/tail light	10
STL80RB	STL80RBP	Third brake light	10
STL89RCB	STL89RCBP	Clear lens stop/turn/tail light	10
ACCESSORIES			
A79CB	A79CBP	Chrome mounting base	10

FMVSS	STL79/89: S T I
	STL80: U
MATERIALS	Polycarbonate lens and housing
VOLT/AMP	STL79/89: 12.8VDC - .350 Stop/Turn, .022A Tail
	STL80: 12.8VDC - .216 Stop
WT/DIMS	.353 lbs. / 17" x 1.375" x 1"
WARRANTY	Lifetime LED Warranty

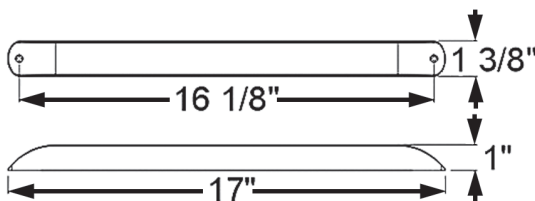

LED COMBINATION
TAIL LIGHTS & KITS



STL76 SERIES Thinline Sealed LED Stop/Turn/Tail Light for Over 80" Wide Applications

PATENTED DESIGN

- Replaceable, snap-on red lens
- Clear lens sonically sealed to housing making light completely waterproof
- Surface mount on 12-7/8" centers
- Meets SAE S2T2I6 for over 80" wide vehicles
- Hard wired with separate ground wire



STL76RB

BULK P/N	POLYPACK P/N	DESCRIPTION	QTY
RED STOP/TURN/TAIL LIGHT - 11 DIODES			
STL76RB	STL76RBP	Stop/turn/tail light	10

FMVSS	S2 T2 I6
MATERIALS	Polycarbonate lens and housing
VOLT/AMP	12.8V / .275A Stop, .022A Tail
WT/DIMS	.529 lbs. / 13.26" x 2.13" x 1.42"
WARRANTY	Lifetime LED Warranty

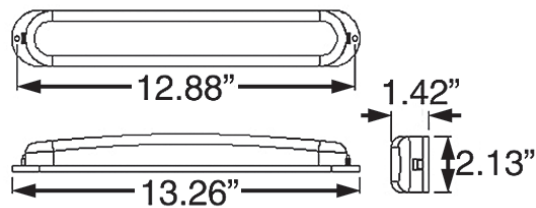

STL52/53 SERIES LED Pedestal Mount Lights

- Lead wires exit through mounting post; separate ground wire
- 21 LEDs per side
- STL53 available in driver and passenger side models with built-in yellow side marker with reflex



STL52ARB



STL52ARB profile

BULK P/N	POLYPACK P/N	DESCRIPTION	QTY
		DUAL FACE RED YELLOW - 42 DIODES	
STL52ARB	STL52ARBP	Round	10
STL53ARPB	STL53ARPBP	Square, passenger side	10
STL53ARDB	STL53ARDBP	Square, driver side	10

FMVSS	STL52ARB:	ST I P
	STL53:	Tail S T I P, Side Marker A P2
MATERIALS	STL52:	Die cast housing, polycarbonate lens
	STL53:	Polycarbonate lens and housing
VOLT/AMP	STL52ARB:	12.8VDC - .360 Stop/Turn, .030A Tail
	STL53:	12.8VDC - .750 Stop/Turn, .114A Tail
WT/DIMS	STL52:	1.477 lbs. / 4.25" x 4.25" x 1.938"
	STL53:	.882 lb. / 4.5" x 4.75" x 2.25"
WARRANTY	Lifetime LED Warranty	



STL53ARPB

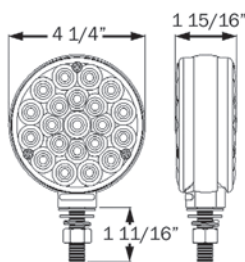

STL52ARB

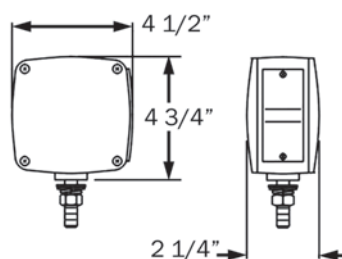

STL53ARDB/ARPB



STL190 SERIES GloLight™ 7" LED Transit Lights

- Sonically sealed, waterproof
- Surface mount light with mounting gasket
- Hard wired with separate ground wire



STOP/
TURN

STL190RB



TAIL
LIGHT

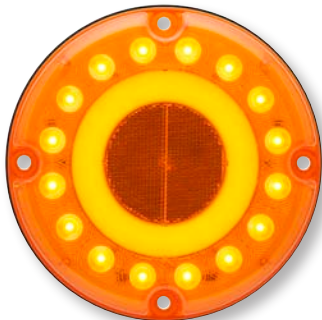

STL190AB

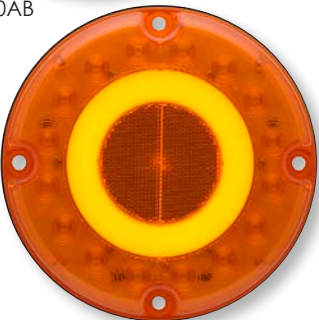

BULK P/N	POLYPACK P/N	DESCRIPTION	QTY
RED STOP/TURN/TAIL LIGHT - 32 DIODES			
STL190RB	STL190RBP	Stop/turn/tail light	5
YELLOW PARKING/TURN SIGNAL - 32 DIODES			
STL190AB	STL190ABP	Parking/turn signal	5

FMVSS	Red S2 I6 T2 P2 A; Yellow I6 P2 A
MATERIALS	Polycarbonate lens and housing
VOLT/AMP	Red: 12.8VDC - .340A Stop/Turn, .135A Tail Yellow: 12.8VDC - .410A Turn, .072A Parking
WT/DIMS	.970 lb. / 7" x 7" x 1.625"
WARRANTY	Lifetime LED Warranty

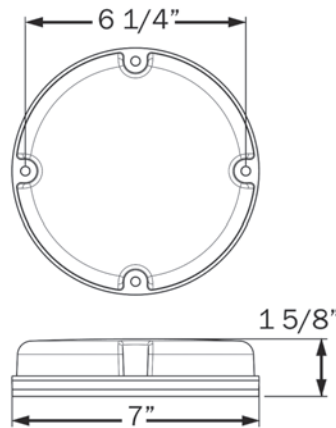

STL90 SERIES 7" Round LED Transit Lights

- Sonically sealed, waterproof
- Surface mount light with mounting gasket
- Hard wired with separate ground wire
- Available in 12V and 24V models

BULK P/N	POLYPACK P/N	DESCRIPTION	QTY
RED STOP/TURN/TAIL LIGHT - 31 DIODES			
STL90RB	STL90RBP	Stop/turn/tail light, 12V	5
STL90R24B	STL90R24BP	Stop/turn/tail light, 24V	5
YELLOW TURN SIGNAL - 31 DIODES			
STL90AB	STL90ABP	Parking/turn signal, 12V	5
STL90A24B	STL90A24BP	Parking/turn signal, 24V	5

FMVSS	Red S2 I6 T2 P2 A; Yellow I6 P2 A
MATERIALS	Polycarbonate lens and housing
VOLT/AMP	Red: 12.8VDC - .243A Stop/Turn, .046A Tail Yellow: 12.8VDC - .275A Turn, .042A Parking
WT/DIMS	.970 lb. / 7" x 7" x 1.438"
WARRANTY	Lifetime LED Warranty

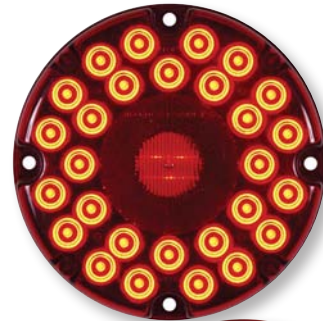
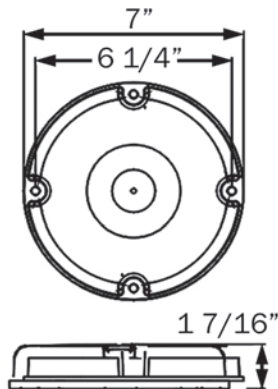

STL90RB

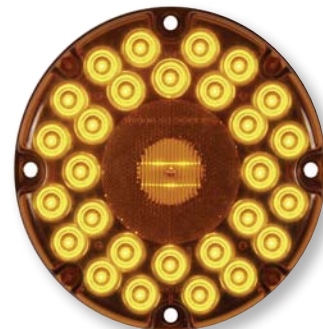

STL90AB

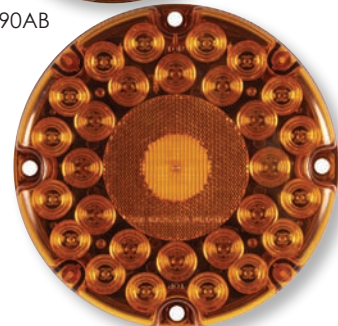



STL161 SERIES GloLight™ LED Combination Tail Lights



TAIL LIGHT

- Stud mount stop/turn/tail light with built-in back-up light and reflex
- 30-LED tail light; 6-LED back-up light
- Driver side light also includes 3-LED license light
- Hard wired; wire exits through back of housing
- Includes ground wire



STOP/TURN



STL161RB

BULK P/N	POLYPACK P/N	DESCRIPTION	QTY
GLOLIGHT™ COMBINATION TAIL LIGHTS - 36 DIODES			
STL161RB	STL161RBP	Passenger side, 30-LED tail, 6-LED back-up	5
STL161RLB	STL161RLBP	Driver side with 3-LED license light	5

FMVSS	STL161RB: A 16 (2)R S2 (3)T STL161RLB: A 16 (2)R S2 (3)T L
MATERIALS	Acrylic lens, plastic housing
VOLT/AMP	12.8VDC - Tail .19A, Stop/Turn .30A, Back-up .21A
WT/DIMS	.882 lb. / 5.813" x 6.75" x 2.688"
WARRANTY	Lifetime LED Warranty

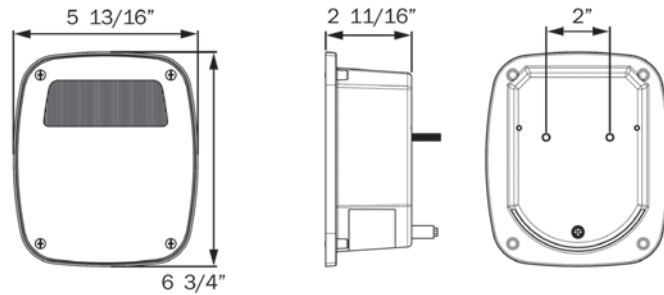

STL60/61 SERIES LED Combination Tail Lights

- Stud mount stop/turn/tail lights with built-in back-up light and reflex
- Choose from Optronics® LED 52-diode and FLEET Count™ 15-diode tail lights
- Hard wired; wire exits through back of housing
- Includes ground wire

BULK P/N	POLYPACK P/N	DESCRIPTION	QTY
OPTRONICS® COMBINATION TAIL LIGHTS - 52 DIODES			
STL60RB	STL60RBP	Passenger side, 16-LED tail, 36-LED back-up	5
STL60RLB	STL60RLBP	Driver side with 5-LED license light	5
FLEET COUNT™ COMBINATION TAIL LIGHTS - 15 DIODES			
STL61RB	STL61RBP	Passenger side, 9-LED tail, 6-LED back-up	5
STL61RLB	STL61RLBP	Driver side with 3-LED license light	5

FMVSS	STL61RB:	A 16 (2)R S2 (3)T
	STL61RLB:	A 16 (2)R S2 (3)T L
MATERIALS	Acrylic lens, plastic housing	
VOLT/AMP	12.8VDC - Tail .015A, Stop/Turn .308A, Back-up .328A	
WT/DIMS	.882 lb. / 5.813" x 6.75" x 2.688"	
WARRANTY	Lifetime LED Warranty	



STL60RB



STL61RB

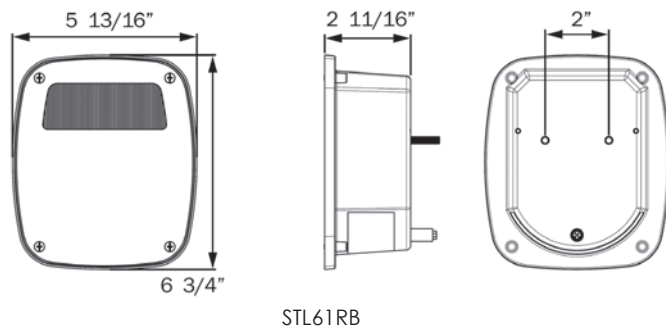
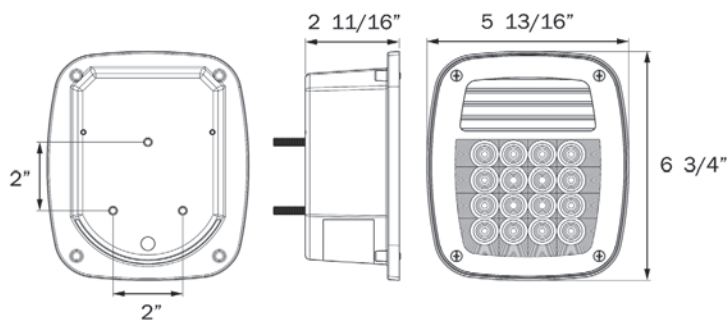

LED COMBINATION
TAIL LIGHTS & KITS



STL108/109 SERIES GloLight™ LED Combination Tail Lights

- Traditional style fits many applications
- Stud mount lights mount on 2" centers
- Hard wired, with separate ground wire



TAIL LIGHT



STOP/TURN

STL108/109RB



TLL190RK

BULK P/N	POLYPACK P/N	DESCRIPTION	QTY
COMBINATION TAIL LIGHTS - 25 DIODES			
STL108RB	STL108RBP	Passenger side	10
STL109RB	STL109RBP	Driver side, 3-LED license light	10
RETAIL			
TLL190RK	Set: STL108RB, STL109RB, mounting hardware; Try Me package, clam		2

FMVSS	Stop/Tail A I S T, Side Marker A P2, License L
MATERIALS	Acrylic lens, ABS housing
VOLT/AMP	12.8VDC - Stop/Turn .310A, Marker .230A
WT/DIMS	.970 lb. / 5.031" x 4.563" x 2.625"
WARRANTY	Lifetime LED Warranty

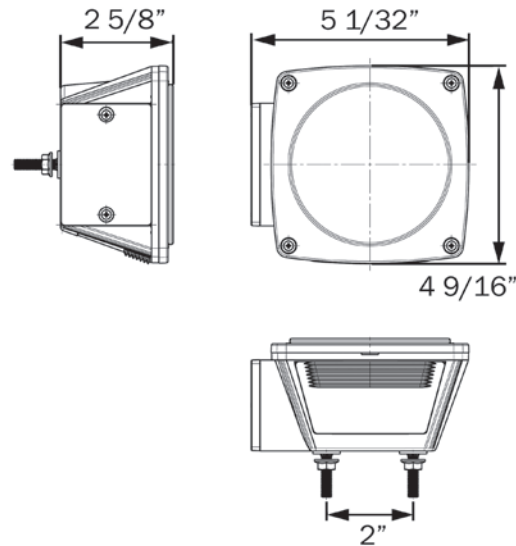

STL8/9 SERIES LED Combination Tail Lights

- Traditional style fits many applications
- Stud mount lights mount on 2" centers
- Hard wired, with separate ground wire

BULK P/N	POLYPACK P/N	DESCRIPTION	QTY
COMBINATION TAIL LIGHTS - 11 DIODES			
STL8RB	STL8RBP	Passenger side	10
STL8R3B	-	Passenger side, female PL-3 plug	10
STL9RB	STL9RBP	Driver side, 3-LED license light	10
STL9R3B	-	Driver side, 3-LED license light, female PL-3 plug	10
RETAIL			
STL6RS	Passenger side		6
STL7RS	Driver side with 3-LED license light		6
TLL9RK	Kit: STL8RB, STL9RB, 25-ft harness, license plate bracket, mounting hardware; clam		2
TLL90RK	Set: STL8RB, STL9RB, mounting hardware; clam		2

FMVSS	Stop/Tail A I S T, Side Marker A P2, License L
MATERIALS	Acrylic lens and plastic housing
VOLT/AMP	12.8VDC - Stop/Turn .259A, Marker .062A
WT/DIMS	.970 lb. / 5.25" x 4.75" x 2.688"
WARRANTY	Lifetime LED Warranty



STL8/9RB
STL6/7RS



TLL9RK



TLL90RK

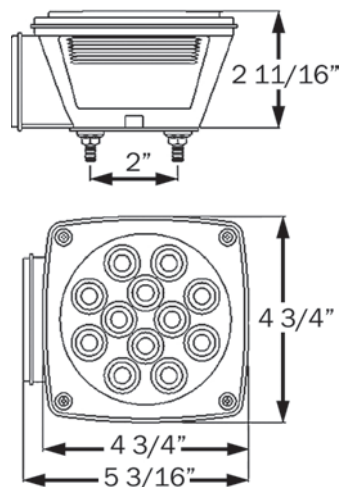



STL2/3 SERIES LED Combination Tail Lights for Over 80" Applications



STL2/3RB

- Designed for over 80" wide applications
- Stud mount lights mount on 2" centers
- Hard wired, with separate ground wire

BULK P/N	POLYPACK P/N	DESCRIPTION	QTY
OVER 80 COMBINATION TAIL LIGHTS - 18 DIODES			
STL2RB	STL2RBP	Passenger side	10
STL3RB	STL3RBP	Driver side, license light	10

FMVSS	Stop/Tail A(3) I(3) S(3) T, Side Marker A P2, License L
MATERIALS	Acrylic lens and plastic housing
VOLT/AMP	12.8VDC - Stop/Turn .268A, Marker .059A
WT/DIMS	.970 lb. / 6.25" x 4.75" x 2.688"
WARRANTY	Lifetime LED Warranty

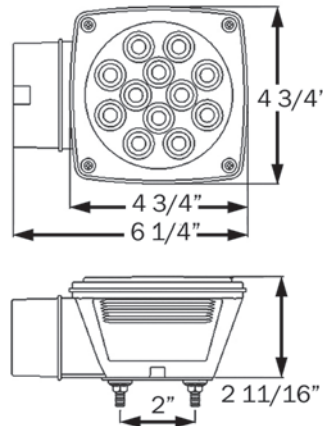

STL28/29 SERIES Miro-Flex™ LED Combination Tail Lights

- Universal design fits many applications
- Stud mount lights mount on 2" centers
- Hard wired with separate ground wire
- STL28 is 6-function: stop, turn, tail, rear reflex, side marker and side reflex
- STL29 is 7-function: above plus license illuminator



STL29RB



STL28RB

BULK P/N	POLYPACK P/N	DESCRIPTION	QTY
COMBINATION TAIL LIGHTS - 15 DIODES			
STL28RB	STL28RBP	Passenger side	10
STL29RB	STL29RBP	Driver side, with 5-LED license light	10
Retail Ready RETAIL			
TLL28RK	Set: STL28RB, STL29RB, mounting hardware; clam		2
TLL29RK	Kit: STL28RB, STL29RB, 25-ft harness, license plate bracket, mounting hardware; clam		2

FMVSS	STL28: Stop/Tail A I S T, Side Marker A P2 STL29: Stop/Tail A I S T, Side Marker A P2, License L
MATERIALS	Acrylic lens and plastic housing
VOLT/AMP	STL28: 12.8VDC - .174A Stop/Turn, .054A Marker STL29: 12.8VDC - .174A Stop/Turn, .054A Marker
WT/DIMS	.750 lb. / 5.25" x 5" x 2.625"
WARRANTY	Lifetime LED Warranty



TLL29RK

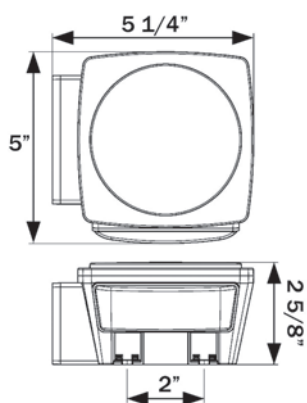



STL116/117 SERIES GloLight™ LED Low Profile Combination Tail Lights



TAIL LIGHT



STOP/TURN



STL116/17RB

- Designed for marine trailer application
- Sealed, waterproof construction
- Universal mount
- Hard wired, with separate ground wire

BULK P/N	POLYPACK P/N	DESCRIPTION	QTY
COMBINATION TAIL LIGHTS - 28 DIODES			
STL116RB	STL116RBP	Passenger side	10
STL117RB	STL117RBP	Driver side, with 6-LED license light	10
RETAIL			
TLL170RK	Set: STL116RB, STL117RB, mounting hardware; clam		2



FMVSS	STL116: A I S T, P2 A
	STL117: A I S T, P2 A, L
MATERIALS	Acrylic lens and plastic housing
VOLT/AMP	12.8VDC - Stop/Turn .252A, Marker .135A
WT/DIMS	.816 lb. / 8" x 2.9" x 2.6"
WARRANTY	Lifetime LED Warranty

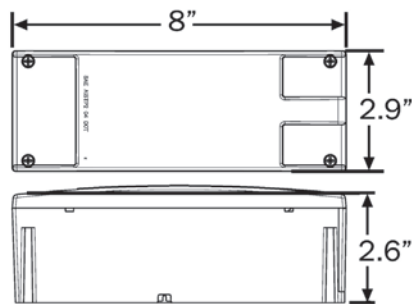



STL14/15 SERIES LED Low Profile Combination Tail Lights

- Designed for marine trailer application
- Sealed, waterproof construction
- Universal mount
- Hard wired, with separate ground wire



STL14/15RB

BULK P/N	POLYPACK P/N	DESCRIPTION	QTY
COMBINATION TAIL LIGHTS - 12 DIODES			
STL14RB	STL14RBP	Passenger side	10
STL15RB	STL15RBP	Driver side, with 6-LED license light	10

FMVSS	STL14: A I S T, P2 A STL15: A I S T, P2 A, L
MATERIALS	Acrylic lens and plastic housing
VOLT/AMP	12.8VDC - Stop/Turn .252A. Marker .135A
WT/DIMS	.816 lb. / 8" x 2.875" x 2.813"
WARRANTY	Lifetime LED Warranty

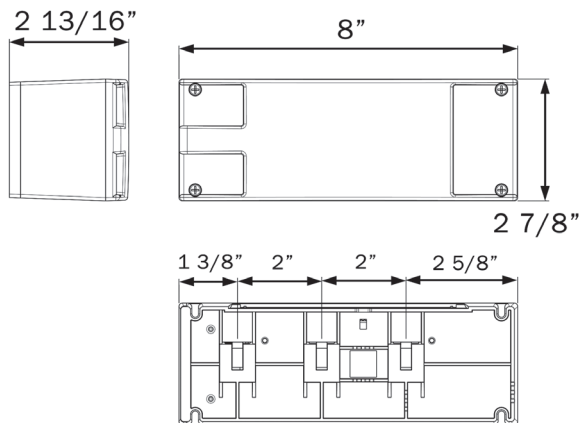



STL16/17 SERIES LED Combination Tail Lights



STL16/17RB

- Designed for marine trailer application
- Sealed, waterproof construction
- Universal mount
- Hard wired, with separate ground wire

BULK P/N	POLYPACK P/N	DESCRIPTION	QTY
COMBINATION TAIL LIGHTS - 18 DIODES			
STL16RB	STL16RBP	Passenger side	10
STL17RB	STL17RBP	Driver side, with 4-LED license light	10
RETAIL			
STL16RS		Passenger side, stainless hardware	6
STL17RS		Driver side with 4-LED license light, stainless hardware	6
TLL160RK		Set: STL16RB, STL17RB, mounting hardware; clam	2
TLL16RK		Kit: STL16RB, STL17RB, 25-ft harness, license plate bracket, stainless steel mounting hardware; clam	2



FMVSS	STL16: Stop/Tail A I S T P2 PC, Side Marker A P2
	STL17: Stop/Tail A I S T P2 PC, Side Marker A P2, License L
MATERIALS	Acrylic lens and plastic housing
VOLT/AMP	STL16: 12.8VDC - .259A Stop/Turn, .062A Marker
	STL17: 12.8VDC - .268A Stop/Turn, .059A Marker
WT/DIMS	.816 lb. / 8.063" x 2.875" x 2.813"
WARRANTY	Lifetime LED Warranty



TLL16RK

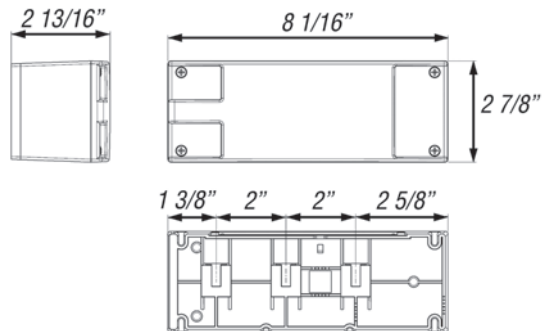

STL26/27 SERIES

Miro-Flex™ LED

Combination Tail Lights

- Designed for marine trailer application
- Sealed, waterproof construction
- Universal mount
- Hard wired, with separate ground wire



STL26RB

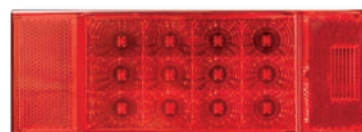

STL27RB

BULK P/N	POLYPACK P/N	DESCRIPTION	QTY
COMBINATION TAIL LIGHTS - 14 DIODES			
STL26RB	STL26RBP	Passenger side	10
STL27RB	STL27RBP	Driver side with 4-LED license light	10

RETAIL

TLL26RK	Set: STL26RB, STL27RB, mounting hardware; clam	2
---------	--	---



FMVSS	STL26: Stop/Tail A I S T PC STL27: Stop/Tail A I S T PC, License L
MATERIALS	Acrylic lens and plastic housing
VOLT/AMP	STL26: 12.8VDC - .167A Stop/Turn, .054A Marker STL27: 12.8VDC - .167A Stop/Turn, .107A Marker/License
WT/DIMS	.882 lb. / 8.063" x 2.938" x 2.688"
WARRANTY	Lifetime LED Warranty

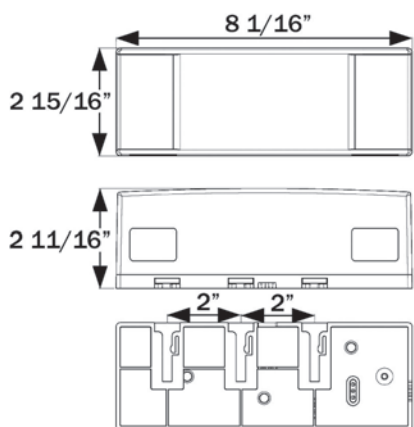

TLL26RK

LED COMBINATION
TAIL LIGHTS & KITS



STL36/37 SERIES LED Combination Tail Lights



STL36/37RB



TLL36RK



- Designed for marine trailer application
- Sealed, waterproof construction
- Universal mount
- Hard wired, with separate ground wire

BULK P/N	POLYPACK P/N	DESCRIPTION	QTY
COMBINATION TAIL LIGHTS - 17 DIODES			
STL36RB	STL36RBP	Passenger side	20
STL36RPG	STL36RPGP	Passenger side, dual plug and ground eyelet	20
STL37RB	STL37RBP	Driver side, 6-LED license light	20
STL37RPG	STL37RPGP	Driver side, 6-LED license light, dual plug and ground eyelet	20
RETAIL			
STL36RS	Passenger side		6
STL37RS	Driver side with 4-LED license light		6
TLL36RK	Kit: STL36RB, STL37RB, (2) MCL91AK sealed yellow marker lights with chrome bases, 25-ft harness, license plate bracket, stainless steel mounting hardware; clam		2

FMVSS	STL36: Stop/Tail A S T I P2, Side Marker A PC STL37: Stop/Tail A S T I P2, Side Marker A PC, License L
MATERIALS	Acrylic lens and plastic housing
VOLT/AMP	12.8VDC - .181A Stop/Turn, .047A Marker
WT/DIMS	.992 lb. / 7.875" x 3.25" x 2.875"
WARRANTY	Lifetime LED Warranty

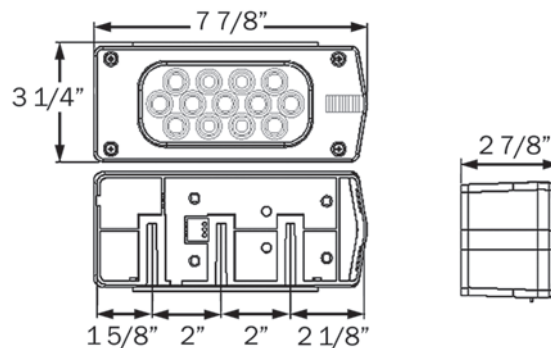

STL56/57 SERIES LED Combination Tail Lights

- Designed for marine trailer application
- Sealed, waterproof construction
- Universal mount
- Hard wired, with separate ground wire
- Stainless steel hardware

BULK P/N	POLYPACK P/N	DESCRIPTION	QTY
COMBINATION TAIL LIGHTS - 18 DIODES			
STL56RB	STL56RBP	Passenger side	10
STL57RB	STL57RBP	Driver side, 5-LED license light	10
RETAIL			
TLL56RK	Kit: STL56RB, STL57RB, 25-ft harness, license plate bracket, stainless steel mounting hardware; clam		2

FMVSS	STL56: Stop/Tail A S T I P2, Side Marker A P2 STL57: Stop/Tail A S T I P2, Side Marker A P2, License L
MATERIALS	Acrylic lens and plastic housing
VOLT/AMP	STL56: 12.8VDC - .259A Stop/Turn, .062A Marker STL57: 12.8VDC - .268A Stop/Turn, .059A Marker
WT/DIMS	.816 lb. / 6.063" x 3.625" x 2.25"
WARRANTY	Lifetime LED Warranty

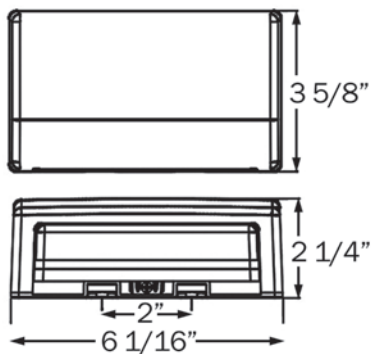

STL56/57RB

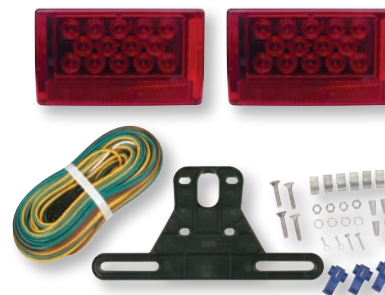

TLL56RK





BUL101 SERIES GloLight™ 4" Round Sealed DOT LED Back-Up Lights



BUL101CB

- Sonically sealed, waterproof
- Certified for back-up light function when installed as pair in two-lamp system [SAE (2)R]

BULK P/N	POLYPACK P/N	DESCRIPTION	QTY
CLEAR BACK-UP LIGHTS - 21 DIODES			
BUL101CB	BUL101CBP	Standard 2-pin connection	10
ACCESSORIES			
A45GB	A45GBP	Grommet	50
A45CB	A45CBP	Pigtail, 2-wire	100
A49PB	A49PBP	Right angle pigtail, 2-wire	100
BK45BB	BK45BBP	Black steel bracket	10
A45BB	A45BBP	Black plastic flange	100
A45SB	A45SBP	Stainless steel mounting flange	20
A45CGB	A45CGBP	Chrome grommet cover	20

FMVSS	(2) R
MATERIALS	Polycarbonate lens and housing
VOLT/AMP	12.8VDC - 0.425A
WT/DIMS	.309 lbs. / 4.313" x 4.313" x 1.625"
WARRANTY	Lifetime LED Warranty

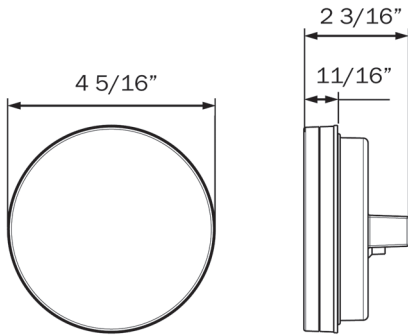

HOLE CUT-OUT: 4.5"

BUL06 SERIES

FLEET Count™ 4" Round Sealed DOT LED Back-Up Lights



- Sonically sealed, waterproof
- Certified for back-up light function when installed as pair in two-lamp system [SAE (2)R]

BULK P/N	POLYPACK P/N	DESCRIPTION	QTY
CLEAR BACK-UP LIGHTS - 6 DIODES			
BUL06CB	BUL06CBP	Grommet mount, 2-pin connection	10
BUL06CFB	BUL06CFBP	Flange mount, 2-pin connection	10
BUL06CFMB	BUL06CFMBP	Flange mount, weathertight connection	10
ACCESSORIES			
A45GB	A45GBP	Grommet	50
A45CB	A45CBP	Pigtail, 2-wire	100
A49PB	A49PBP	Right angle pigtail, 2-wire	100
BK45BB	BK45BBP	Black steel bracket	10
A45BB	A45BBP	Black plastic flange	100
A45SB	A45SBP	Stainless steel mounting flange	20
A45CGB	A45CGBP	Chrome grommet cover	20

FMVSS	(2) R
MATERIALS	Polycarbonate lens and housing
VOLT/AMP	12.8VDC - 0.180A
WT/DIMS	.309 lbs. / 4.25" x 4.25" x 1.625"
WARRANTY	Lifetime LED Warranty



BUL06CB



BUL06CFB

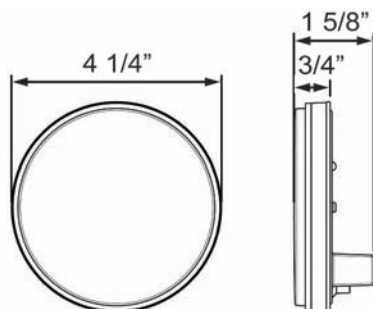

BUL06CB

HOLE CUT-OUT: 4.528"

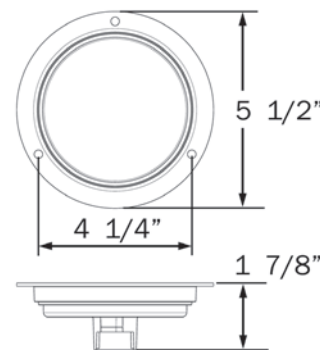

BUL06CFB

HOLE CUT-OUT: 4.579"

LED DOT COMPLIANT
BACK-UP LIGHTS



BUL11CB

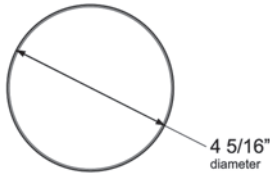

HOLE CUT-OUT: 4.5"



BUL11CBX

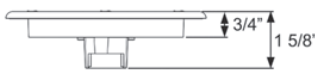
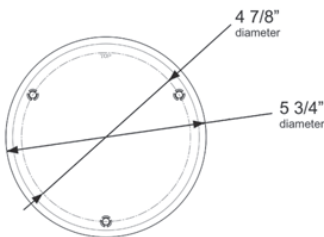

HOLE CUT-OUT: 4.5"

BUL11 SERIES 4" Round Sealed Clear DOT LED Back-Up Lights

- Sonically sealed, waterproof
- Certified for back-up light function when installed as pair in two-lamp system [SAE (2)R]
- Available in grommet and flange mount models
- Grommet mount version available with standard 2-pin, or optional weathertight connection
- Grommet mount version available in 12V and 24V

BULK P/N	POLYPACK P/N	DESCRIPTION	QTY
----------	--------------	-------------	-----

CLEAR BACK-UP LIGHTS - 10 DIODES

BUL11CB	BUL11CBP	12V, two-pin connection	10
BUL11CKB	BUL11CKBP	12V kit: BUL11CB, A45GB & A49PB	10
BUL11CMB	BUL11CMBP	12V, weathertight connection	10
BUL11CM24B	BUL11CM24BP	24V, weathertight connection	10

CLEAR BACK-UP LIGHT WITH REFLEX - 10 DIODES

BUL11CBX	BUL11CBXP	12V	10
----------	-----------	-----	----

ACCESSORIES

A45GB	A45GBP	Grommet	50
A45CB	A45CBP	Pigtail, 2-wire	100
A49PB	A49PBP	Right angle pigtail, 2-wire	100

FMVSS	(2) R
MATERIALS	Polycarbonate lens and housing
VOLT/AMP	12.8VDC - 0.26A
WT/DIMS	BUL11CB/CKB: .309 lbs. / 4.313" x 4.313" x 1.625"
	BUL11CMB/CM24B: .309 lbs. / 4.313" x 4.313" x 1.625"
	BUL11CBX: .353 lbs. / 5.75" x 5.75" x 1.625"
WARRANTY	Lifetime LED Warranty

BUL23/53 SERIES 4" Round Sealed Clear DOT LED Back-Up Lights



- Sonically sealed, waterproof
- Certified for back-up light function when installed as pair in two-lamp system [SAE (2)R]
- High diode count; choose from 27- or 36-LED models
- 27-LED version available in 12V and 24V

BULK P/N	POLYPACK P/N	DESCRIPTION	QTY
CLEAR BACK-UP LIGHTS - 27 DIODES			
BUL23CB	BUL23CBP	12V, two-pin connection	10
BUL23C24B	BUL23C24BP	24V, two-pin connection	10
CLEAR BACK-UP LIGHT - 36 DIODES			
BUL53CB	BUL53CBP	12V, two-pin connection	10
BUL53CKB	BUL53CKBP	12V Kit: BUL53CB, A45GB & A49PB	10
ACCESSORIES			
A45GB	A45GBP	Grommet	50
A45CB	A45CBP	Pigtail, 2-wire	100
A49PB	A49PBP	Right angle pigtail, 2-wire	100

FMVSS	(2) R
MATERIALS	Polycarbonate lens and housing
VOLT/AMP	BUL23: 12.8VDC - 0.145A BUL53: 12.8VDC - 0.275A
WT/DIMS	.309 lbs. / 4.313" x 4.313" x 2"
WARRANTY	Lifetime LED Warranty



BUL23CB



BUL53CB

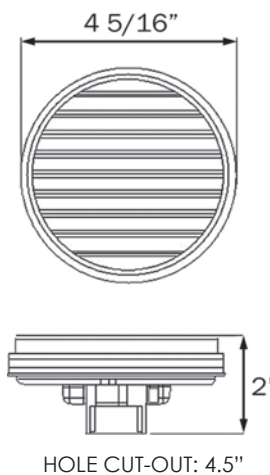

LED DOT COMPLIANT
BACK-UP LIGHTS



BUL111 SERIES GloLight™ 6" Oval Sealed DOT LED Back-Up Lights



BUL111CB

- Sonically sealed, waterproof
- Certified for back-up light function when installed as pair in two-lamp system [SAE (2)R]

BULK P/N	POLYPACK P/N	DESCRIPTION	QTY
CLEAR BACK-UP LIGHTS - 22 DIODES			
BUL111CB	BUL111CBP	Standard two-pin connection	10
ACCESSORIES			
A70GB	A70GBP	Grommet	50
A45CB	A45CBP	Pigtail, 2-wire	100
A49PB	A49PBP	Right angle pigtail, 2-wire	100

FMVSS	(2) R
MATERIALS	Polycarbonate lens and housing
VOLT/AMP	12.8VDC - 0.386A
WT/DIMS	.265 lbs. / 6.5" x 2.375" x 1.75"
WARRANTY	Lifetime LED Warranty

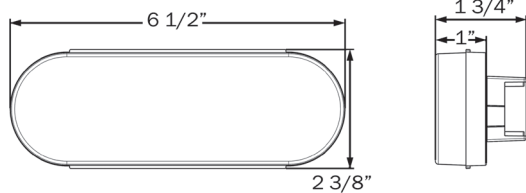

HOLE CUT-OUT: 6.85" x 2.52" (1.26" R)

BUL12 SERIES

FLEET Count™ 6" Oval Sealed DOT LED Back-Up Lights

- Sonically sealed, waterproof
- Available with standard or weathertight connection
- Certified for back-up light function when installed as pair in two-lamp system [SAE (2)R]



BUL12CB



BUL12CFB

BULK P/N	POLYPACK P/N	DESCRIPTION	QTY
CLEAR BACK-UP LIGHTS - 6 DIODES			
BUL12CB	BUL12CBP	Recess mount	10
BUL12CFB	BUL12CFBP	Recess flange mount	10
BUL12CFMB	BUL12CFMBP	Recess flange mount, weathertight connection	10
ACCESSORIES			
A70GB	A70GBP	Grommet	50
A45CB	A45CBP	Pigtail, 2-wire	100
A49PB	A49PBP	Right angle pigtail, 2-wire	100
A111TRSSB	A111TRSSBP	Stainless steel trim ring for flange	50

FMVSS	(2) R
MATERIALS	Polycarbonate lens and housing
VOLT/AMP	12.8VDC - 0.260A
WT/DIMS	.265 lbs. / 6.5" x 2.25" x 1.75"
WARRANTY	Lifetime LED Warranty

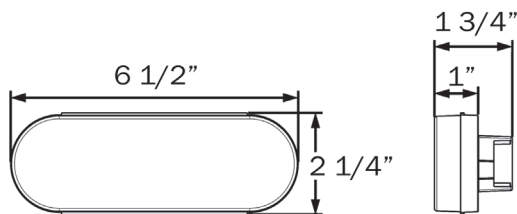

BUL12CB

HOLE CUT-OUT: 6.85" x 2.5" (1.25" R)

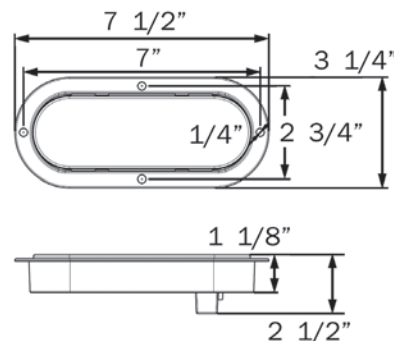

BUL12CFB

HOLE CUT-OUT: 6.713" x 2.5" (1.25" R)

LED DOT COMPLIANT
BACK-UP LIGHTS



BUL10/22/52 SERIES 6" Oval Sealed Clear DOT LED Back-Up Lights



BUL10CB

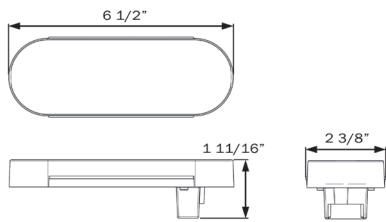

HOLE CUT-OUT: 6.85" x 2.5" (1.25" R)



BUL22CB



BUL52CB

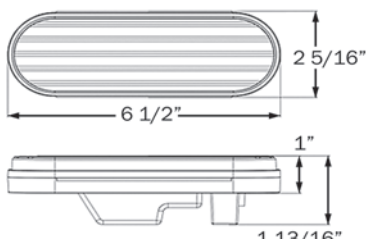

HOLE CUT-OUT: 6.85" x 2.5" (1.25" R)

- Sonically sealed, waterproof
- Certified for back-up light function when installed as pair in two-lamp system [SAE (2)R]
- Low to high diode count; choose from 10-, 27- or 36-LED models
- Accept standard two-pin plugs

BULK P/N	POLYPACK P/N	DESCRIPTION	QTY
CLEAR BACK-UP LIGHTS - 10 DIODES			
BUL10CB	BUL10CBP	Standard two-pin connection	10
BUL10CMB	BUL10CMBP	Weathertight connection	10
CLEAR BACK-UP LIGHT - 27 DIODES			
BUL22CB	BUL22CBP	Standard two-pin connection	10
CLEAR BACK-UP LIGHT - 36 DIODES			
BUL52CB	BUL52CBP	Standard two-pin connection	10
ACCESSORIES			
A70GB	A70GBP	Grommet	50
A45CB	A45CBP	Pigtail, 2-wire	100
A49PB	A49PBP	Right angle pigtail, 2-wire	100

FMVSS	(2) R
MATERIALS	Polycarbonate lens and housing
VOLT/AMP	BUL10: 12.8VDC - 0.260A BUL22: 12.8VDC - 0.125A BUL52: 12.8VDC - 0.275A
WT/DIMS	BUL10: .265 lbs. / 6.438" x 2.25" x 1.75" BUL22/52: .397 lbs. / 6.5" x 2.313" x 1.813"
WARRANTY	Lifetime LED Warranty

BUL35/90 SERIES Sealed Clear DOT LED Back-Up Lights

- Sonically sealed, waterproof
- Certified for back-up light function when installed as pair in two-lamp system [SAE (2)R]
- BUL35 is 5.5" x 3.5" recess mount model that accepts standard two-pin plugs
- BUL90 is 7" surface mount model, hard wired, with separate ground wire; designed for transit vehicles

BULK P/N	POLYPACK P/N	DESCRIPTION	QTY
CLEAR 5.5" x 3.5" BACK-UP LIGHT - 16 DIODES			
BUL35CB	BUL35CBP	Standard two-pin connection, 12V	10
CLEAR 7" BACK-UP LIGHT - 42 DIODES			
BUL90CB	BUL90CBP	12V, hard wired	5
BUL90C24B	BUL90C24BP	24V, hard wired	5
ACCESSORIES			
A33GB	A33GBP	Grommet for BUL35CB	50
A45CB	A45CBP	Pigtail, 2-wire	100
A49PB	A49PBP	Right angle pigtail, 2-wire	100

FMVSS	(2) R
MATERIALS	Polycarbonate lens and housing
VOLT/AMP	BUL35: 12.8VDC - 0.295A BUL90: 12.8VDC - 0.301A BUL90: 24.0VDC - 0.089A
WT/DIMS	BUL35: .397 lbs. / 5.313" x 3.438" x 2.313" BUL90: .970 lbs. / 7" x 7" x 1.438"
WARRANTY	Lifetime LED Warranty



BUL35CB

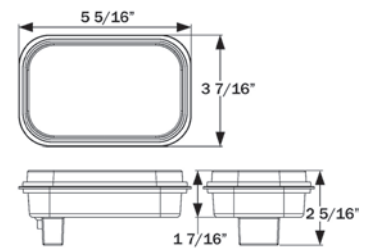
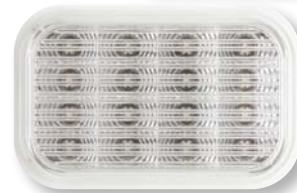

HOLE CUT-OUT: 5.462" x 3.562" (1" R)

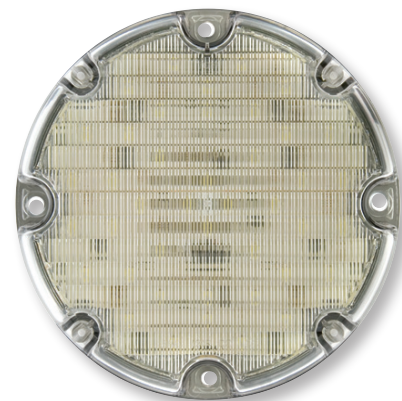

BUL90CB

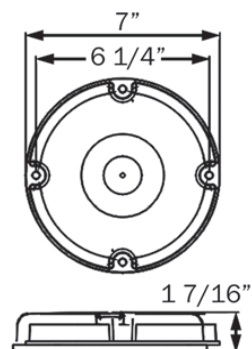



SLL43 SERIES

4" Round Sealed LED Warning Lamps



SLL43AB1
SLL43AB2

- Sonically sealed, waterproof
- Flashing lights with triple-flash function, meeting SAE J595 and J845 standards for Class 2 and Class 3 directional warning lamps
- Use two Function 1 or Function 2 lights for synchronous flashing or pair a Function 1 with a Function 2 light for alternating flash pattern
- Accepts standard PL-3 plugs
- Operating voltage 9-30VDC, suitable for 12V or 24V systems

BULK P/N	POLYPACK P/N	DESCRIPTION	QTY
4" ROUND WARNING LAMPS - 22 DIODES			
SLL43AB1	SLL43AB1P	12V-24V Function 1	10
SLL43AB2	SLL43AB2P	12V-24V Function 2	20/10
SLL43AKB1	SLL43AKB1P	12V-24V Function 1, kit with A45GB & A45PB	10
SLL43AKB2	SLL43AKB2P	12V-24V Function 2, kit with A45GB & A45PB	10
ACCESSORIES			
A45GB	A45GBP	Grommet, 4" round	50
A45PB	A45PBP	Pigtail, 3-wire	100
A47PB	A47PBP	Right angle pigtail, 3-wire	100

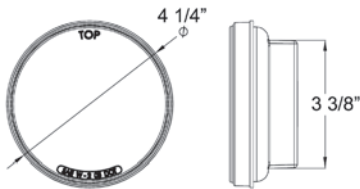

HOLE CUT-OUT: 4.5"

FMVSS	W-2
MATERIALS	Polycarbonate lens and housing
VOLT/AMP	12.8VDC - 0.448A
WT/DIMS	.60 lbs. / 4.25" x 4.25" x 1.75"
WARRANTY	Lifetime LED Warranty

SLL72 SERIES 6" Oval Sealed LED Warning Lamps

- Sonically sealed, waterproof
- Flashing lights with triple-flash function, meeting SAE J595 and J845 standards for Class 2 and Class 3 directional warning lamps
- Use two Function 1 or Function 2 lights for synchronous flashing or pair a Function 1 with a Function 2 light for alternating flash pattern
- Accepts standard PL-3 plugs
- Operating voltage 9-30VDC, suitable for 12V or 24V systems

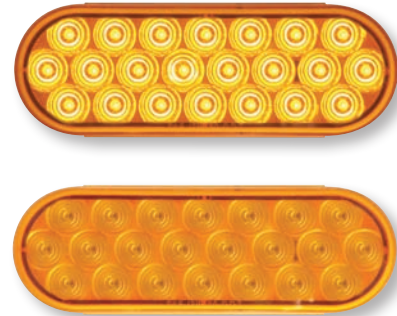

SLL72AB1
SLL72AB2

BULK P/N	POLYPACK P/N	DESCRIPTION	QTY
6" OVAL WARNING LAMPS - 22 DIODES			
SLL72AB1	SLL72AB1P	12V-24V Function 1	10
SLL72AB2	SLL72AB2P	12V-24V Function 2	10
SLL72AKB1	SLL72AKB1P	12V-24V Function 1, kit with A70GB & A45PB	10
SLL72AKB2	SLL72AKB2P	12V-24V Function 2, kit with A70GB & A45PB	10
ACCESSORIES			
A70GB	A70GBP	Grommet, 6" oval	50
A45PB	A45PBP	Pigtail, 3-wire	100
A47PB	A47PBP	Right angle pigtail, 3-wire	100

FMVSS	W-2
MATERIALS	Polycarbonate lens and housing
VOLT/AMP	12.8VDC - 0.448A
WT/DIMS	.62 lbs. / 6.5" x 2.375" x 1.75"
WARRANTY	Lifetime LED Warranty

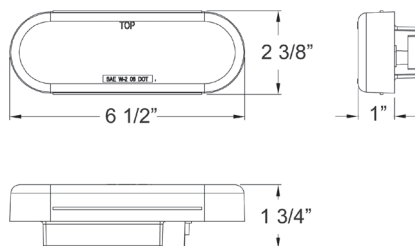

HOLE CUT-OUT: 6.85" x 2.5" (1.25" R)



GloLight™ M1 SERIES 6.5" LED Marker/Clearance Lights

- Sealed, waterproof design
- Hard wired, includes separate ground wire



M1 LED WITH BEZEL



M1 CLEAR LENS LED WITH BEZEL

BULK P/N	POLYPACK P/N	DESCRIPTION	QTY
YELLOW - 13 DIODES			
11212307B	11212355P	.180 male bullets	100
11212376B	11212356P	Clear lens, .180 male bullets	50
RED - 13 DIODES			
11212309B	11212357P	.180 male bullets	50
11212378B	11212358P	Clear lens, .180 male bullets	100
ACCESSORIES			
00212317B	00212327P	Bezel	200/20

FMVSS	P2
MATERIALS	Polycarbonate lens, housing and bezel
VOLT/AMP	12.8VDC - 0.12A
WT/DIMS	.132 lbs. / 6.625" x 2.188" x 1"
WARRANTY	Three Year Warranty

GLOLIGHT M1 SERIES

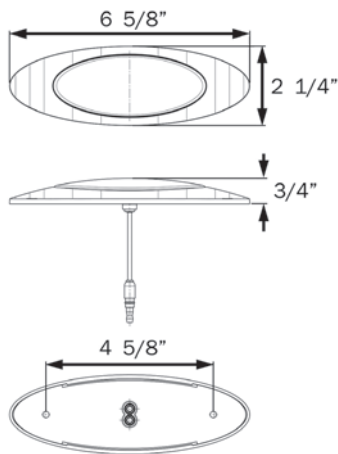

HOLE CUT-OUT: 1.5"

GLOLIGHT M3 SERIES

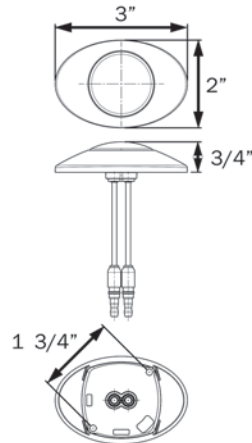

HOLE CUT-OUT: 1.375"

GLOLIGHT M5 SERIES

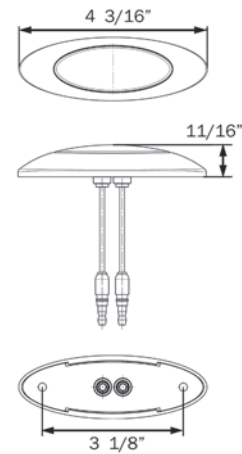

HOLE CUT-OUT: 1"

GloLight™ M3 SERIES 3" LED Marker/Clearance Lights

- Sealed, waterproof design
- Hard wired, includes separate ground wire

BULK P/N	POLYPACK P/N	DESCRIPTION	QTY
YELLOW - 5 DIODES			
11212207B	11212255P	.180 male bullets	200
11212276B	11212256P	Clear lens, .180 male bullets	50
RED - 5 DIODES			
11212209B	11212257P	.180 male bullets	50
11212278B	11212258P	Clear lens, .180 male bullets	200
ACCESSORIES			
00212217B	00212227P	Bezel	500/20

FMVSS	P2
MATERIALS	Polycarbonate lens, housing and bezel
VOLT/AMP	12.8VDC - 0.12A
WT/DIMS	.132 lbs. / 3" x 2" x 1"
WARRANTY	Three Year Warranty

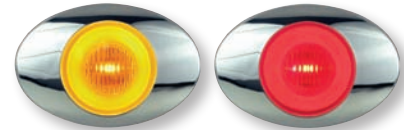

M3 LED WITH BEZEL

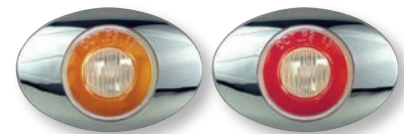

M3 CLEAR LENS LED WITH BEZEL

GloLight™ M5 SERIES 4" LED Marker/Clearance Lights

- Sealed, waterproof design
- Hard wired, includes separate ground wire

BULK P/N	POLYPACK P/N	DESCRIPTION	QTY
YELLOW - 3 DIODES			
11212700B	11212708P	.180 male bullets	200
11212702B	11212710P	Clear lens, .180 male bullets	200
RED - 3 DIODES			
11212701B	11212709P	.180 male bullets	200
11212703B	11212711P	Clear lens, .180 male bullets	200
ACCESSORIES			
00212717B	00212727P	Bezel	500/20

FMVSS	P2
MATERIALS	Polycarbonate lens, housing and bezel
VOLT/AMP	12.8VDC - 0.033A
WT/DIMS	.066 lb. / 4.156" x 1.5" x .75"
WARRANTY	Three Year Warranty



M5 LED WITH BEZEL



M1 SERIES Millennium Series™ 6.5" Sealed LED Marker/Clearance Lights

- Sealed, waterproof design
- Hard wired, includes separate ground wire
- Available with .180 male bullets or metripack connector
- Choose from light only or kit with chrome bezel



M1 LED WITH BEZEL



M1 CLEAR LENS LED WITH BEZEL



M1 LED WITH BEZEL



M1 CLEAR LENS LED WITH BEZEL

BULK P/N	POLYPACK P/N	DESCRIPTION	QTY
YELLOW - 4 DIODES			
00212307B	00212355P	.180 male bullets	100/10
00212376B	00212356P	Clear lens, .180 male bullets	50/10
-	00212335P	Kit: .180 male bullets, bezel	10
-	00212336P	Kit: Clear lens, .180 male bullets, bezel	10
00212315B	00212365P	Metripack connector	100/10
00212384B	00212366P	Clear lens, metripack connector	100/10
-	00212345P	Kit: Metripack connector, bezel	10
-	00212346P	Kit: Clear lens, metripack connector, bezel	10
RED - 4 DIODES			
00212309B	00212357P	.180 male bullets	50/10
00212378B	00212358P	Clear lens, .180 male bullets	100/10
-	00212337P	Kit: .180 male bullets, bezel	10
-	00212338P	Kit: Clear lens, .180 male bullets, bezel	10
00212316B	00212367P	Metripack connector	100/10
00212386B	00212368P	Clear lens, metripack connector	100/10
-	00212347P	Kit: Metripack connector, bezel	10
ACCESSORIES			
00212317B	00212327P	Bezel	200/20



FMVSS	P2
MATERIALS	Polycarbonate lens, housing and bezel
VOLT/AMP	12.8VDC - 0.12A
WT/DIMS	.132 lbs. / 6.625" x 2.188" x 1"
WARRANTY	Three Year Warranty

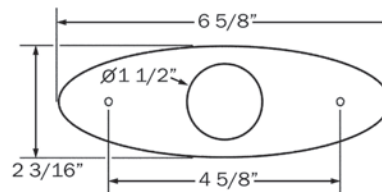

HOLE CUT-OUT: 1.5"

M3 SERIES

Millennium Series™ 3" Sealed LED Marker/Clearance Lights

- Sealed, waterproof design
- Hard wired, includes separate ground wire
- Available with .180 male bullets or metripack connector
- Choose from light only or kit with chrome bezel

BULK P/N	POLYPACK P/N	DESCRIPTION	QTY
YELLOW - 2 DIODES			
00212207B	00212255P	.180 male bullets	200/10
00212276B	00212256P	Clear lens, .180 male bullets	50/10
-	00212235P	Kit: .180 male bullets, bezel	10
-	00212236P	Kit: Clear lens, .180 male bullets, bezel	10
-	00212261P	Metripack connector	10
00212213B	00212263P	Clear lens, metripack connector	50/10
RED - 2 DIODES			
00212209B	00212257P	.180 male bullets	50/10
00212278B	00212258P	Clear lens, .180 male bullets	200/10
-	00212237P	Kit: .180 male bullets, bezel	10
-	00212238P	Kit: Clear lens, .180 male bullets, bezel	10
-	00212262P	Metripack connector	50/10
00212214B	00212254P	Clear lens, metripack connector	100
ACCESSORIES			
00212217B	00212227P	Bezel	500/20

FMVSS	P2
MATERIALS	Polycarbonate lens, housing and bezel
VOLT/AMP	12.8VDC - 0.12A
WT/DIMS	.132 lbs. / 3" x 2" x 1"
WARRANTY	Three Year Warranty

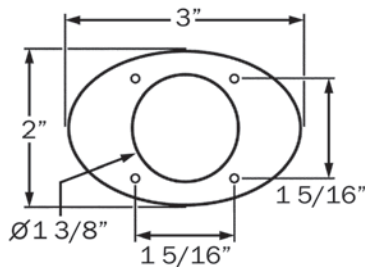

HOLE CUT-OUT: 1.375"



M3 LED WITH BEZEL



M3 CLEAR LENS LED WITH BEZEL



M3 LED WITH BEZEL



M3 CLEAR LENS LED WITH BEZEL





M4 LED MARKER/CLEARANCE LIGHTS WITH BEZEL

M4 SERIES Millennium Series™ 9" Sealed LED Lights

- Sealed, waterproof design
- Hard wired, includes separate ground wire
- Available with .180 male bullets or amp connector
- Chrome trim ring included in kits or available separately

BULK P/N	POLYPACK P/N	DESCRIPTION	QTY
YELLOW MARKER/CLEARANCE - 6 DIODES			
00212104B	00212155P	.180 male bullets	10
-	00212135P	Kit: .180 male bullets, bezel	10
RED MARKER/CLEARANCE - 6 DIODES			
00212108B	00212157P	.180 male bullets	32/10
-	00212137P	Kit: .180 male bullets, bezel	10
ACCESSORIES			
00212117B	00212127P	Bezel	70/20
00212757B	00212757P	3-wire weather tight plug, .180 male bullets	50
00212767B	-	2-wire weather tight plug, .180 male bullets	50

FMVSS	P2
MATERIALS	Polycarbonate lens, housing and bezel
VOLT/AMP	12.8VDC - 0.090A
WT/DIMS	.132 lbs. / 9" x 3.25" x 1"
WARRANTY	Three Year Warranty

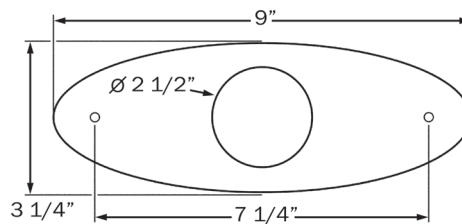

HOLE CUT-OUT: 2.5"

M5 SERIES Millennium Series™ 4" Sealed LED Marker/Clearance Lights

- Sealed, waterproof design
- Hard wired, includes separate ground wire
- Available with .180 male bullets or metripack connector
- Choose from light only or kit with chrome bezel

BULK P/N	POLYPACK P/N	DESCRIPTION	QTY
YELLOW - 3 DIODES			
00212700B	00212708P	.180 male bullets	200/10
00212702B	00212710P	Clear lens, .180 male bullets	200/10
-	00212704P	Kit: .180 male bullets, bezel	10
-	00212706P	Kit: Clear lens, .180 male bullets, bezel	10
00212713B	00212713P	Metripack connector	200/10
-	00212712P	Clear lens, metripack connector	10
RED - 3 DIODES			
00212701B	00212709P	.180 male bullets	200/10
00212703B	00212711P	Clear lens, .180 male bullets	200/10
-	00212705P	Kit: .180 male bullets, bezel	10
-	00212707P	Kit: Clear lens, .180 male bullets, bezel	10
00212715B	00212714P	Clear lens, metripack connector	200/10
ACCESSORIES			
00212717B	00212727P	Bezel	500/20

FMVSS	P2
MATERIALS	Polycarbonate lens, housing and bezel
VOLT/AMP	12.8VDC - 0.033A
WT/DIMS	.066 lb. / 4.156" x 1.5" x .75"
WARRANTY	Three Year Warranty

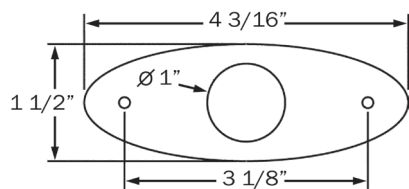

HOLE CUT-OUT: 1"



M5 LED WITH BEZEL



M5 CLEAR LENS LED WITH BEZEL



M5 LED WITH BEZEL



M5 CLEAR LENS LED WITH BEZEL





MCL110 SERIES

GloLight™ Uni-Lite™ 3/4" LED Non-Directional Marker/Clearance Lights



MCL110AB



MCL110RB



MCL110AKB



MCL110RKB

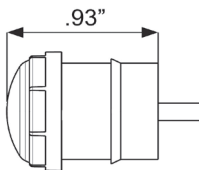
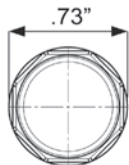

- Sealed, waterproof design
- PC rated when mounted in any direction - 360 degrees!
- Hard wired, includes separate ground wire
- Choose from light only or kit with A11GB grommet

BULK P/N	POLYPACK P/N	DESCRIPTION	QTY
YELLOW - PC RATED - 2 DIODES			
MCL110AB	MCL110ABP	Light only	50
MCL110AKB	MCL110AKBP	Light with A11GB grommet	50
RED - PC RATED - 2 DIODES			
MCL110RB	MCL110RBP	Light only	50
MCL110RKB	MCL110RKBP	Light with A11GB grommet	50
ACCESSORIES			
A11GB	A11GBP	Grommet	100
A12GB	-	Sealing grommet, .070-.125"	100
A14GB	-	Sealing grommet, .125-.250"	100
A11PB	-	Black plastic snap-in flange	100
A11SSB	-	Stainless steel grommet cover	100
A11SRB	-	Locking flange; use with A11PB	100
A11AXB	-	Yellow reflector	100
A11RXB	-	Red reflector	100

FMVSS	PC
MATERIALS	Polycarbonate lens and housing
VOLT/AMP	12.8VDC - 0.052A
WT/DIMS	.022 lbs. / .073" x .073" x 0.938"
WARRANTY	Lifetime LED Warranty



A11RXB

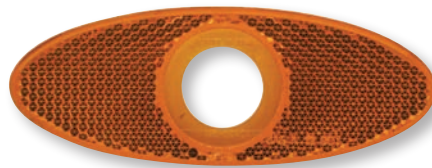

A11AXB

MCL111 SERIES GloLight™ Uni-Lite™ 3/4" Sealed LED Marker/Clearance Lights

GloLight™

PC Rated

- Sealed, waterproof design
- PC rated two diode models
- Hard wired, includes separate ground wire
- Available with optional plugs
- Choose from light only or kit with A11GB grommet
- Dual function models MCL121AK9PVG/RK9PVG provide a supplemental stop/turn function

BULK P/N	POLYPACK P/N	DESCRIPTION	QTY
YELLOW - PC RATED - 2 DIODES			
MCL111AB	MCL111ABP	Light only	50
MCL111AKB	MCL111AKBP	Light with A11GB grommet	50
MCL111AKFPG	MCL111AKFPGP	Kit with .156 female bullets, A11GB	50
MCL111AKPG	MCL111AKPGP	Kit with .180 male bullets, A11GB	50
MCL121AK9PVG	MCL121AK9PVGP	Supplemental turn - kit with closed grommet, .180 male bullets	20
RED - PC RATED - 2 DIODES			
MCL111RB	MCL111RBP	Light only	50
MCL111RKB	MCL111RKBP	Light with A11GB grommet	50
MCL111RKFP	MCL111RKFP	Kit with .156 female bullets, A11GB	50
MCL111RKPG	MCL111RKPGP	Kit with .180 male bullets, A11GB	50
MCL121RK9PVG	MCL121RK9PVGP	Supplemental turn - kit with closed grommet, .180 male bullets	20
ACCESSORIES			
A11GB	A11GBP	Grommet	100
A12GB	-	Sealing grommet, .070-.125"	100
A14GB	-	Sealing grommet, .125-.250"	100
A11PB	-	Black plastic snap-in flange	100
A11SSB	-	Stainless steel grommet cover	100
A11SRB	-	Locking flange; use with A11PB	100
A11AXB	-	Yellow reflector	100
A11RXB	-	Red reflector	100

FMVSS	PC
MATERIALS	Polycarbonate lens and housing
VOLT/AMP	12.8VDC - 0.085A
WT/DIMS	.022 lbs. / .75" x .75" x 0.875"
WARRANTY	Lifetime LED Warranty

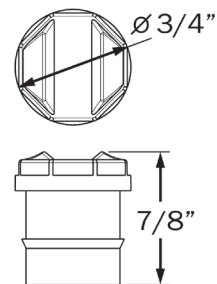

SEALED LED MARKER/
CLEARANCE LIGHTS



MCL112 SERIES GloLight™ Uni-Lite™ 3/4" Sealed LED Marker/Clearance Lights



MCL112AKB



MCL112RKB



MCL112RK3B

- Sealed, waterproof design
- P2 rated single diode models
- Hard wired, includes separate ground wire
- Choose from light only or kit with A11GB grommet
- Dual function model MCL122RK3B provides a supplemental stop function

BULK P/N	POLYPACK P/N	DESCRIPTION	QTY
YELLOW - P2 RATED - 1 DIODE			
MCL112AB	MCL112ABP	Light only	50
MCL112AKB	MCL112AKBP	Light with A11GB grommet	50
RED - P2 RATED - 1 DIODE			
MCL112RB	MCL112RBP	Light only	50
MCL112RKB	MCL112RKBP	Light with A11GB grommet	50
RED - ID LIGHT HARNESS			
MCL122RK3B	MCL122RK3BP	Identification light harness: (3) red lights with supplemental stop function, .180 male bullets	20
ACCESSORIES			
A11GB	A11GBP	Grommet	100
A12GB	-	Sealing grommet, .070-.125"	100
A14GB	-	Sealing grommet, .125-.250"	100
A11PB	-	Black plastic snap-in flange	100
A11SSB	-	Stainless steel grommet cover	100
A11SRB	-	Locking flange; use with A11PB	100
A11AXB	-	Yellow reflector	100
A11RXB	-	Red reflector	100

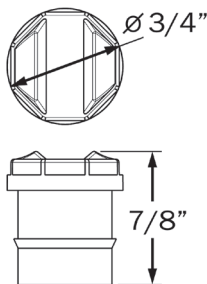

FMVSS	P2
MATERIALS	Polycarbonate lens and housing
VOLT/AMP	12.8VDC - .075A
WT/DIMS	.022 lbs. / .75" x .75" x 0.875"
WARRANTY	Lifetime LED Warranty

MCL11 SERIES Uni-Lite™ 3/4" Sealed LED Marker/Clearance Lights



- Sealed, waterproof design
- PC rated two diode models
- Hard wired, includes separate ground wire

BULK P/N	POLYPACK P/N	DESCRIPTION	QTY
YELLOW - PC RATED - 2 DIODES			
MCL11AB	MCL11ABP	Light only	50
MCL11APG	MCL11APGP	Light with .180 male bullets	50
MCL11CAB	MCL11CABP	Light only, clear lens	50
MCL11AKB	MCL11AKBP	Kit with A11GB grommet	50
MCL11CAKB	MCL11CAKBP	Kit with A11GB, clear lens	50
MCL11CAKPG	-	Kit with A11GB, clear lens, .180 male bullets	50
MCL11CAKBF	-	Kit with A11GB, clear lens, .156 female barrels	50
MCL11AHPG	-	Kit with .180 male bullets, A11GB	50
MCL11AKAB	MCL11AKABP	Kit with .156 female barrels, A11GB	50
MCL11AKBF	MCL11AKBFP	Kit with .156 female barrels, A11GB	50
MCL11AK12B	-	Kit with 12" leads, A11GB	50
MCL11AK12PG	-	Kit with 12" leads, A11GB, .156 male bullets	50
MCL11AKPVG	-	Kit with sealed grommet, .180 male bullets	50
-	MCL11AKBSSP	Kit with 12" leads, A11GB, A11SSB	50
RED - PC RATED - 2 DIODES			
MCL11RB	MCL11RBP	Light only	50
MCL11RPG	MCL11RPGP	Light with .180 male bullets	50
MCL11CRB	MCL11CRBP	Light only, clear lens	50
MCL11RKB	MCL11RKBP	Kit with A11GB grommet	50
MCL11CRKB	MCL11CRKBP	Kit with A11GB, clear lens	50
MCL11CRKPG	-	Kit with A11GB, clear lens, .180 male bullets	50
MCL11CRKBF	-	Kit with A11GB, clear lens, .156 female barrels	50
MCL11RHPG	-	Kit with .180 male bullets, A11GB	50
MCL11RKAB	-	Kit with .156 female connectors, A11GB	50
MCL11RKBF	MCL11RKBF	Kit with .156 female barrels, A11GB	50
MCL11RK12B	-	Kit with 12" leads, A11GB	50
MCL11RK12PG	-	Kit with 12" leads, A11GB, .156 male bullets	50
MCL11RKPVG	-	Kit with sealed grommet, .180 male bullets	50
-	MCL11RKBSSP	Kit with 12" leads, A11GB, A11SSB	50

See Accessories section at back of catalog or listing on previous pages for additional mounting options

FMVSS	PC
MATERIALS	Polycarbonate lens and housing
VOLT/AMP	12.8VDC - 0.03A
WT/DIMS	.022 lbs. / .074" x .074" x 0.90"
WARRANTY	Lifetime LED Warranty



MCL11AB



MCL11RB



MCL11AKB



MCL11RKB

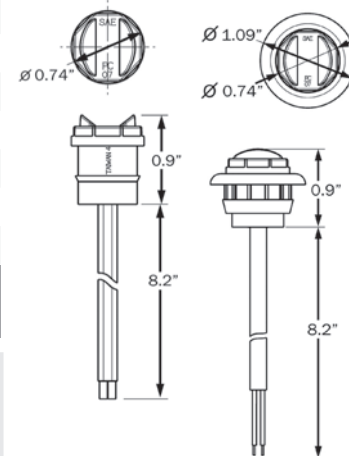

HOLE CUT-OUT: 0.75"

SEALED LED MARKER/
CLEARANCE LIGHTS



MCL12 SERIES Uni-Lite™ 3/4" Sealed LED Marker/Clearance Lights - P2

- Sealed, waterproof, P2 rated single diode models
- Hard wired, includes separate ground wire
- Three-piece identification light harnesses available; MCL22RK3B includes supplemental turn function
- MCL922RB is three-piece identification light bar



MCL12AKB



MCL12RKB



MCL12RK3B



MCL922RB

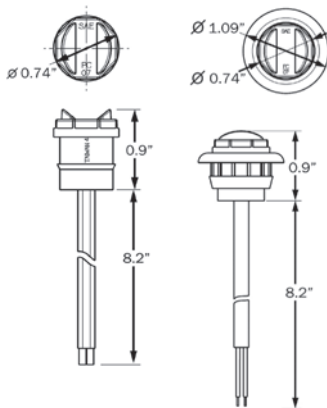

HOLE CUT-OUT: 0.75"

BULK P/N	POLYPACK P/N	DESCRIPTION	QTY
YELLOW - P2 RATED - 1 DIODE			
MCL12AB	MCL12ABP	Light only	50
MCL12AKB	MCL12AKBP	Light kit with A11GB	50
MCL12AKPG	-	Light kit with .180 male bullets, A11GB	50
MCL12AK156PG	-	Light kit with .156 male bullets, A11GB	50
RED - P2 RATED - 1 DIODE			
MCL12RB	MCL12RBP	Light only	50
MCL12RKB	MCL12RKBP	Light kit with A11GB	50
MCL12RKPG	-	Light kit with .180 male bullets, A11GB	50
MCL12RK156PG	-	Light kit with .156 male bullets, A11GB	50
RED IDENTIFICATION LIGHT KIT WITH MOLDED HARNESS			
MCL12RK3B	MCL12RK3BP	(3) red MCL12 lights	50
MCL12RK3RMB	-	(3) red MCL12 lights, weathertight plug	50
MCL22RK3B	MCL22RK3BP	(3) red MCL12 lights, supplemental turn function	50
RED IDENTIFICATION LIGHT BAR			
MCL922RB	MCL922RBP	(3) red MCL12 lights, molded bar, black	50
ACCESSORIES			
A11GB	A11GBP	Grommet	100
A12GB	-	Sealing grommet, .070-.125"	100
A14GB	-	Sealing grommet, .125-.250"	100
A11PB	-	Black plastic snap-in flange	100
A11SSB	-	Stainless steel grommet cover	100
A11SRB	-	Locking flange; use with A11PB	100
A11AXB	-	Yellow reflector	100
A11RXB	-	Red reflector	100
RETAIL			
MCL12AK		Yellow light kit, card/slipover blister	12
MCL12RK		Red light kit, card/slipover blister	12
FMVSS	P2		
MATERIALS	Polycarbonate lens and housing		
VOLT/AMP	12.8VDC - 0.047A		
WT/DIMS	.022 lbs. / .074" x .074" x 0.90"		
WARRANTY	Lifetime LED Warranty		

MCL12AR SERIES

Uni-Lite™ 3/4" Sealed LED Marker/Clearance Lights - P2



- Sealed, waterproof, P2 rated single diode lights pre-installed in durable ABS, surface mount bracket
- Hard wired, includes separate ground wire
- Available with clear or tinted lenses



MCL12ARRB
MCL12ARLB

BULK P/N	POLYPACK P/N	DESCRIPTION	QTY
		YELLOW / RED FENDER LIGHTS	
MCL12ARLB	MCL12ARLBP	Driver side assembly, 2-wire	50/20
MCL12ARRB	MCL12ARRBP	Passenger side assembly, 2-wire	50/20
MCL12A2RLB	-	Driver side assembly, self grounding	50
MCL12A2RRB	-	Passenger side assembly, self grounding	50
MCL12CARLB	-	Driver side assembly, clear lens	20
MCL12CARRB	-	Passenger side assembly, clear lens	20
ACCESSORIES			
A11GB	A11GBP	Grommet	100

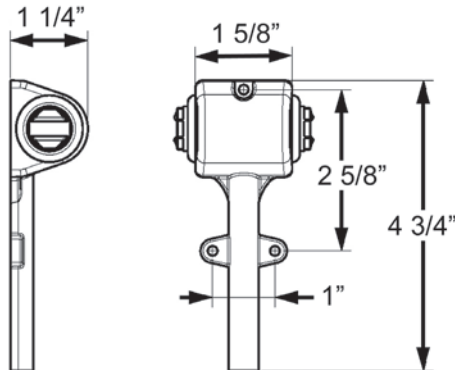

MCL12CARRB
MCL12CARLB

SEALED LED MARKER/
CLEARANCE LIGHTS



MCL21/23 SERIES 2" & 2.5" Sealed LED Beehive Style Marker/Clearance Lights

- Sonically sealed, waterproof
- Clearance, side marker, or rear tracking light applications
- Accepts standard two-pin PL-10 plug



MCL21AB



MCL21RB



MCL23AB



MCL23RB

BULK P/N	POLYPACK P/N	DESCRIPTION	QTY
YELLOW - 8 DIODES			
MCL21AB	MCL21ABP	2" light	20
MCL23AB	MCL23ABP	2.5" light	20
RED - 8 DIODES			
MCL21RB	MCL21RBP	2" light	20
MCL23RB	MCL23RBP	2.5" light	20
ACCESSORIES			
A46PB	A46PBP	Straight PL-10 plug, 6" lead	100
A86PB	A86PBP	Straight PL-10 plug, 18" lead	100
A54GB	A54GBP	2" Flush mount grommet	100
A54GK	A54GKP	2" Kit: A54GB and A46PB	100
A55CB	A55CBP	2" Chrome trim ring	20
A55GB	A55GBP	2.5" Flush mount grommet (open back)	50
A56GB	A56GBP	2.5" Recess mount grommet (closed back)	100
A57GB	A57GBP	2.5" Recess mount grommet (open back)	50
A55GK	A55GKP	2.5" Kit: A55GB and A46PB	100
A57GK	A57GKP	2.5" Kit: A57GB and A46PB	100
A57CB	A57CBP	2.5" Chrome trim ring	20
BK5557GB	BK5557GBP	2"/2.5" Cam-on mounting bracket	50

FMVSS	P2
MATERIALS	Polycarbonate lens and housing
VOLT/AMP	MCL21: 12.8VDC - 0.061A MCL23: 12.8VDC - 0.051A
WT/DIMS	MCL21: .110 lbs. / 2" x 2" x 1.75" MCL23: .176 lbs. / 2.5" x 2.5" x 2.313"
WARRANTY	Lifetime LED Warranty

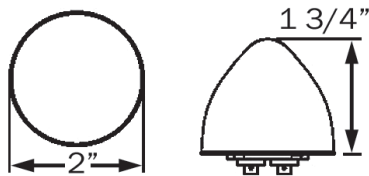

MCL21 SERIES
HOLE CUT-OUT: 2.313"

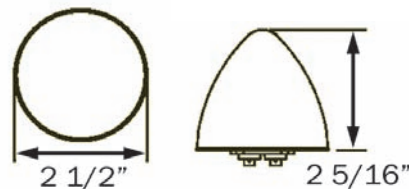

MCL23 SERIES
HOLE CUT-OUT: 2.75"

MCL155 SERIES

GloLight™ 2" Round Sealed LED Marker/Clearance Lights



- Sonically sealed, waterproof
- Accepts standard two-pin PL-10 plug
- Recess grommet and flange mount models available

BULK P/N	POLYPACK P/N	DESCRIPTION	QTY
YELLOW - 6 DIODES			
MCL155AB	MCL155ABP	Grommet mount	20
MCL155AFB	MCL155AFBP	Flange mount	20
RED - 6 DIODES			
MCL155RB	MCL155RBP	Grommet mount	20
MCL155RFB	MCL155RFBP	Flange mount	20
ACCESSORIES			
A46PB	A46PBP	Straight PL-10 plug, 6" lead	100
A86PB	A86PBP	Straight PL-10 plug, 18" lead	100
A54GB	A54GBP	2" Flush mount grommet	100
A54GK	A54GKP	2" Kit: A54GB and A46PB	100
A55CB	A55CBP	2" Chrome trim ring	20
BK5557GB	BK5557GBP	Cam-on mounting bracket	50

FMVSS	P2
MATERIALS	Polycarbonate lens and housing
VOLT/AMP	12.8VDC - 0.06A
WT/DIMS	MCL155: .066 lbs. / 2" x 2" x 1" MCL155FRB: .078 lbs. / 2.938" x 2.938" x .938"
WARRANTY	Lifetime LED Warranty



MCL155AB



MCL155RB



MCL155AFB



MCL155RFB

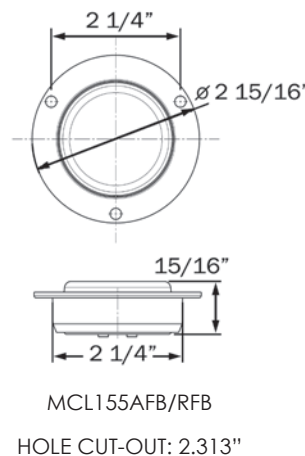
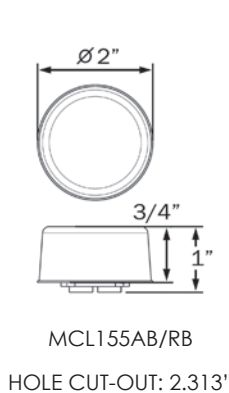

SEALED LED MARKER/
CLEARANCE LIGHTS



MCL55 SERIES 2" Round Sealed LED Marker/Clearance Lights

- Sonically sealed, waterproof
- Accepts standard two-pin PL-10 plug
- Available in 12V and 12-24V models



MCL55AB



MCL55RB



MCL55ACB
MCL55RCB
UCL55CB

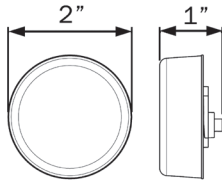

HOLE CUT-OUT: 2.313"



MCL55FRB

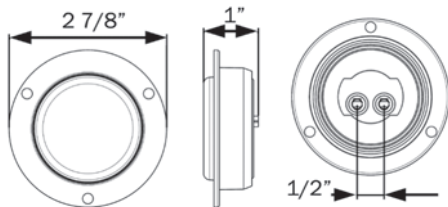

HOLE CUT-OUT: 2.313"

BULK P/N	POLYPACK P/N	DESCRIPTION	QTY
YELLOW - 3 DIODES			
MCL55AB	MCL55ABP	Grommet mount, 12V	20
MCL55ACB	MCL55ACBP	Clear lens grommet mount, 12V	20
MCL55A1224B	-	Grommet mount, 12-24V	20
MCL55AKB	-	Kit with grommet and plug, 12V	20
RED - 3 DIODES			
MCL55RB	MCL55RBP	Grommet mount, 12V	20
MCL55RCB	MCL55RCBP	Clear lens grommet mount, 12V	20
MCL55R1224B	-	Grommet mount, 12-24V	20
MCL55RKB	-	Kit with grommet and plug, 12V	20
MCL55FRB	-	Flange mount, 12V	50
UTILITY LIGHT - 3 DIODES			
UCL55CB	-	White LED, 12V	20
ACCESSORIES			
A46PB	A46PBP	Straight PL-10 plug, 6" lead	100
A86PB	A86PBP	Straight PL-10 plug, 18" lead	100
A54GB	A54GBP	2" Flush mount grommet	100
A54GK	A54GKP	2" Kit: A54GB and A46PB	100
A55CB	A55CBP	2" Chrome trim ring	20
BK5557GB	BK5557GBP	Cam-on mounting bracket	50
RETAIL			
MCL55AK	Yellow kit with A54GB & A46PB, clam		12
MCL55RK	Red kit with A54GB & A46PB, clam		12

FMVSS	P2
MATERIALS	Polycarbonate lens and housing
VOLT/AMP	12.8VDC - 0.06A
WT/DIMS	MCL55: .066 lbs. / 2" x 2" x 1" MCL55FRB: .078 lbs. / 2.875" x 2.875" x 1"
WARRANTY	Lifetime LED Warranty

MCL56 SERIES FLEET Count™ 2" Round Sealed LED Marker/Clearance Lights

- Sonically sealed, waterproof
- Accepts standard two-pin PL-10 plug
- Multiple mounting options available

BULK P/N	POLYPACK P/N	DESCRIPTION	QTY
YELLOW - 1 DIODE			
MCL56AB	MCL56ABP	Light only	20
RED - 1 DIODE			
MCL56RB	MCL56RBP	Light only	20
ACCESSORIES			
A46PB	A46PBP	Straight PL-10 plug, 6" lead	100
A86PB	A86PBP	Straight PL-10 plug, 18" lead	100
A54GB	A54GBP	2" Flush mount grommet	100
A54GK	A54GKP	2" Kit: A54GB and A46PB	100
A55CB	A55CBP	2" Chrome trim ring	20
BK5557GB	BK5557GBP	Cam-on mounting bracket	50
RETAIL			
MCL56AK		Yellow kit with A54GB & A46PB, clam	12
MCL56AS		Yellow light only, clam	12
MCL56RK		Red kit with A54GB & A46PB, clam	12
MCL56RS		Red light only, clam	12

FMVSS	P2
MATERIALS	Polycarbonate lens and housing
VOLT/AMP	12.8VDC - 0.045A
WT/DIMS	.066 lbs. / 2" x 2" x 1"
WARRANTY	Lifetime LED Warranty



MCL56AB



MCL56RB

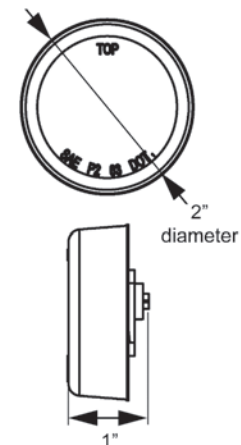

HOLE CUT-OUT: 2.313"

SEALED LED MARKER/
CLEARANCE LIGHTS



MCL50 SERIES

Miro-Flex™ 2" Round Sealed LED Marker/Clearance Lights

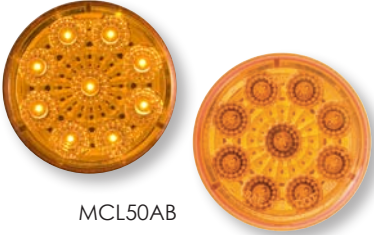

MCL50AB

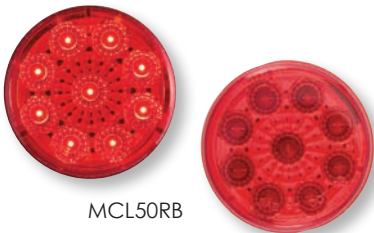

MCL50RB

- Sonically sealed, waterproof
- Accepts standard two-pin PL-10 plug
- Multiple mounting options available

BULK P/N	POLYPACK P/N	DESCRIPTION	QTY
YELLOW - 9 DIODES			
MCL50AB	MCL50ABP	Light only	20
RED - 9 DIODES			
MCL50RB	MCL50RBP	Light only	20
ACCESSORIES			
A46PB	A46PBP	Straight PL-10 plug, 6" lead	100
A86PB	A86PBP	Straight PL-10 plug, 18" lead	100
A54GB	A54GBP	2" Flush mount grommet	100
A54GK	A54GKP	2" Kit: A54GB and A46PB	100
A55CB	A55CBP	2" Chrome trim ring	20
BK5557GB	BK5557GBP	Cam-on mounting bracket	50

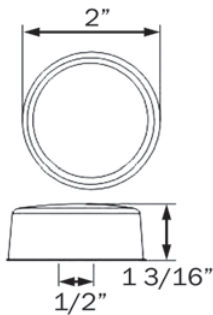

HOLE CUT-OUT: 2.313"

FMVSS	P2
MATERIALS	Polycarbonate lens and housing
VOLT/AMP	12.8VDC - 0.047A
WT/DIMS	.088 lbs. / 2" x 2" x 1.188"
WARRANTY	Lifetime LED Warranty

MCL52/54 SERIES

2" Round Sealed LED Marker/Clearance Lights



- Sonically sealed, waterproof
- Accepts standard two-pin PL-10 plug
- PC rated: functions as both clearance and side marker light when properly mounted on a 45 degree angle
- Available in flange mount and grommet mount models



MCL54AB



MCL54RB

BULK P/N	POLYPACK P/N	DESCRIPTION	QTY
YELLOW - 5 DIODES			
MCL52AB	MCL52ABP	Flange mount, PL-10 connection	20
MCL52AMB	-	Flange mount, weathertight connection; pigtail included	20
MCL54AB	MCL54ABP	Grommet mount, PL-10 connection	20
RED - 5 DIODES			
MCL52RB	MCL52RBP	Flange mount, PL-10 connection	20
MCL52RMB	-	Flange mount, weathertight connection; pigtail included	20
MCL54RB	MCL54RBP	Grommet mount, PL-10 connection	20
ACCESSORIES			
A46PB	A46PBP	Straight PL-10 plug, 6" lead	100
A86PB	A86PBP	Straight PL-10 plug, 18" lead	100
A54GB	A54GBP	2" Flush mount grommet	100
A54GK	A54GKP	2" Kit: A54GB and A46PB	100
A55CB	A55CBP	2" Chrome trim ring	20
BK5557GB	BK5557GBP	Cam-on mounting bracket	50
A52GB	-	Gasket for flange mount, black	100

FMVSS	P2 PC
MATERIALS	Polycarbonate lens and housing
VOLT/AMP	12.8VDC - 0.063A
WT/DIMS	Flange mount: .088 lbs. / 2.938" x 2.938" x 0.938" Grommet mount: .066 lbs. / 2.063" x 2.063" x 0.875"
WARRANTY	Lifetime LED Warranty



MCL52AB

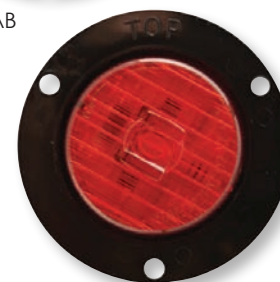

MCL52RB



detail of weathertight connection on MCL52AMB/RMB; pigtail included

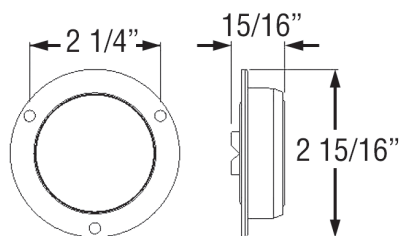

MCL52

HOLE CUT-OUT: 2.313"

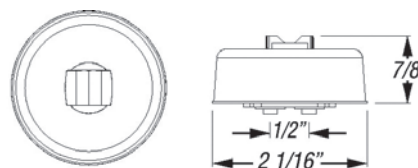

MCL54

HOLE CUT-OUT: 2.313"

SEALED LED MARKER/
CLEARANCE LIGHTS

GloLight™**MCL157 SERIES****GloLight™ 2.5" Round Sealed LED
Marker/Clearance Lights**

- Sonically sealed, waterproof
- Accepts standard two-pin PL-10 plug



MCL157AB



MCL157RB



BULK P/N	POLYPACK P/N	DESCRIPTION	QTY
YELLOW - 9 DIODES			
MCL157AB	MCL157ABP	Light only	20
RED - 9 DIODES			
MCL157RB	MCL157RBP	Light only	20
ACCESSORIES			
A46PB	A46PBP	Straight PL-10 plug, 6" lead	100
A86PB	A86PBP	Straight PL-10 plug, 18" lead	100
A55GB	A55GBP	Flush mount grommet (open back)	50
A56GB	A56GBP	Recess mount grommet (closed back)	100
A57GB	A57GBP	Recess mount grommet (open back)	50
A55GK	A55GKP	Kit: A55GB and A46PB	100
A57GK	A57GKP	Kit: A57GB and A46PB	100
A57CB	A57CBP	Chrome trim ring	20
BK5557GB	BK5557GBP	Cam-on mounting bracket	50

FMVSS	P2
MATERIALS	Polycarbonate lens and housing
VOLT/AMP	12.8VDC - 0.099A
WT/DIMS	.132 lbs. / 2.5" x 2.5" x 1.125"
WARRANTY	Lifetime LED Warranty

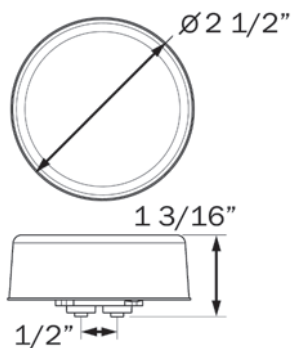

HOLE CUT-OUT: 2.75"

MCL57 SERIES 2.5" Round Sealed LED Marker/Clearance Lights

- Sonically sealed, waterproof
- Accepts standard two-pin PL-10 plug
- Available in 12V and 24V models

BULK P/N	POLYPACK P/N	DESCRIPTION	QTY
YELLOW - 3 DIODES			
MCL57AB	MCL57ABP	Light only, 12V	20
MCL57A24B	MCL57A24BP	Light only, 24V	20
MCL57ACB	MCL57ACBP	Clear lens light only, 12V	20
MCL57AKB	-	Kit with grommet and plug	20
RED - 3 DIODES			
MCL57RB	MCL57RBP	Light only, 12V	20
MCL57R1224B	-	Light only, 12-24V	20
MCL57R24B	MCL57R24BP	Light only, 24V	20
MCL57RCB	MCL57RCBP	Clear lens light only, 12V	20
MCL57RKB	-	Kit with grommet and plug	20
ACCESSORIES			
A46PB	A46PBP	Straight PL-10 plug, 6" lead	100
A86PB	A86PBP	Straight PL-10 plug, 18" lead	100
A55GB	A55GBP	Flush mount grommet (open back)	50
A56GB	A56GBP	Recess mount grommet (closed back)	100
A57GB	A57GBP	Recess mount grommet (open back)	50
A55GK	A55GKP	Kit: A55GB and A46PB	100
A57GK	A57GKP	Kit: A57GB and A46PB	100
A57CB	A57CBP	Chrome trim ring	20
BK5557GB	BK5557GBP	Cam-on mounting bracket	50
RETAIL			
MCL57AK		Yellow kit with A55GB & A46PB, clam	12
MCL57RK		Red kit with A55GB & A46PB, clam	12

FMVSS	P2
MATERIALS	Polycarbonate lens and housing
VOLT/AMP	12.8VDC - 0.06A
WT/DIMS	.132 lbs. / 2.5" x 2.5" x 1"
WARRANTY	Lifetime LED Warranty



MCL57AB



MCL57RB



MCL57ACB/RCB

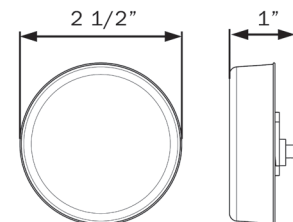

HOLE CUT-OUT: 2.75"

SEALED LED MARKER/
CLEARANCE LIGHTS



MCL527 SERIES FLEET Count™ 2.5" Round Sealed LED Marker/Clearance Lights

- Sonically sealed, waterproof
- Accepts standard two-pin PL-10 plug
- Multiple mounting options available



MCL527AB



MCL527RB



HOLE CUT-OUT: 2.75"

BULK P/N	POLYPACK P/N	DESCRIPTION	QTY
YELLOW - 2 DIODES			
MCL527AB	MCL527ABP	Light only	20
RED - 2 DIODES			
MCL527RB	MCL527RBP	Light only	20
ACCESSORIES			
A46PB	A46PBP	Straight PL-10 plug, 6" lead	100
A86PB	A86PBP	Straight PL-10 plug, 18" lead	100
A55GB	A55GBP	Flush mount grommet (open back)	50
A56GB	A56GBP	Recess mount grommet (closed back)	100
A57GB	A57GBP	Recess mount grommet (open back)	50
A55GK	A55GKP	Kit: A55GB and A46PB	100
A57GK	A57GKP	Kit: A57GB and A46PB	100
A57CB	A57CBP	Chrome trim ring	20
BK5557GB	BK5557GBP	Cam-on mounting bracket	50
RETAIL			
MCL527AK		Yellow kit with A57GB & A46PB, clam	12
MCL527AS		Yellow light only, clam	12
MCL527RK		Red kit with A57GB & A46PB, clam	12
MCL527RS		Red light only, clam	12

FMVSS	P2
MATERIALS	Polycarbonate lens and housing
VOLT/AMP	12.8VDC - 0.034A
WT/DIMS	.088 lbs. / 2.5" x 2.5" x 1.063"
WARRANTY	Lifetime LED Warranty

MCL51 SERIES

Miro-Flex™ 2.5" Round Sealed LED Marker/Clearance Lights

- Sonically sealed, waterproof
- Accepts standard two-pin PL-10 plug
- Multiple mounting options available

BULK P/N	POLYPACK P/N	DESCRIPTION	QTY
YELLOW - 3 DIODES			
MCL51AB	MCL51ABP	Light only	20
RED - 3 DIODES			
MCL51RB	MCL51RBP	Light only	20
ACCESSORIES			
A46PB	A46PBP	Straight PL-10 plug, 6" lead	100
A86PB	A86PBP	Straight PL-10 plug, 18" lead	100
A55GB	A55GBP	Flush mount grommet (open back)	50
A56GB	A56GBP	Recess mount grommet (closed back)	100
A57GB	A57GBP	Recess mount grommet (open back)	50
A55GK	A55GKP	Kit: A55GB and A46PB	100
A57GK	A57GKP	Kit: A57GB and A46PB	100
A57CB	A57CBP	Chrome trim ring	20
BK5557GB	BK5557GBP	Cam-on mounting bracket	50

FMVSS	P2
MATERIALS	Polycarbonate lens and housing
VOLT/AMP	12.8VDC - 0.033A
WT/DIMS	.088 lbs. / 2.5" x 2.5" x 1.188"
WARRANTY	Lifetime LED Warranty



MCL51AB



MCL51RB

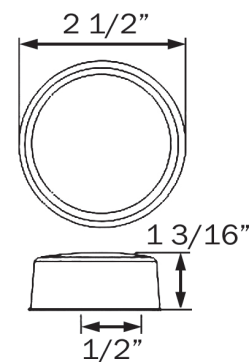

HOLE CUT-OUT: 2.75"

SEALED LED MARKER/
CLEARANCE LIGHTS



MCL58 SERIES

2.5" Round Sealed LED Marker/Clearance Lights



MCL58AB



MCL58ACB



MCL58RB

- Sonically sealed, waterproof
- Accepts standard two-pin PL-10 plug
- Multiple mounting options available
- PC rated: functions as both clearance and side marker light when properly mounted on a 45 degree angle

BULK P/N	POLYPACK P/N	DESCRIPTION	QTY
YELLOW - 7 DIODES			
MCL58AB	MCL58ABP	Light only	20
MCL58ACB	MCL58ACBP	Clear lens, yellow diodes, light only	20
RED - 7 DIODES			
MCL58RB	MCL58RBP	Light only	20
ACCESSORIES			
A46PB	A46PBP	Straight PL-10 plug, 6" lead	100
A86PB	A86PBP	Straight PL-10 plug, 18" lead	100
A55GB	A55GBP	Flush mount grommet (open back)	50
A56GB	A56GBP	Recess mount grommet (closed back)	100
A57GB	A57GBP	Recess mount grommet (open back)	50
A55GK	A55GKP	Kit: A55GB and A46PB	100
A57GK	A57GKP	Kit: A57GB and A46PB	100
A57CB	A57CBP	Chrome trim ring	20
BK5557GB	BK5557GBP	Cam-on mounting bracket	50

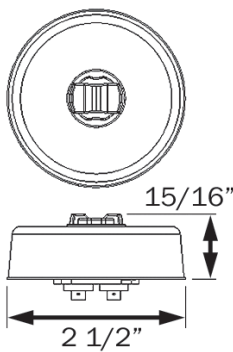

HOLE CUT-OUT: 2.75"

FMVSS	P2 PC
MATERIALS	Polycarbonate lens and housing
VOLT/AMP	12.8VDC - 0.057A
WT/DIMS	.132 lbs. / 2.5" x 2.5" x 0.938"
WARRANTY	Lifetime LED Warranty

MCL59 SERIES

2.5" Round Sealed LED Marker/ Clearance Lights with Reflex

- Sonically sealed, waterproof
- Accepts standard two-pin PL-10 plug
- Multiple mounting options available
- Built-in reflex eliminates the need for a separate reflector

BULK P/N	POLYPACK P/N	DESCRIPTION	QTY
YELLOW - 8 DIODES			
MCL59AB	MCL59ABP	Light only	20
RED - 8 DIODES			
MCL59RB	MCL59RBP	Light only	20
ACCESSORIES			
A46PB	A46PBP	Straight PL-10 plug, 6" lead	100
A86PB	A86PBP	Straight PL-10 plug, 18" lead	100
A55GB	A55GBP	Flush mount grommet (open back)	50
A56GB	A56GBP	Recess mount grommet (closed back)	100
A57GB	A57GBP	Recess mount grommet (open back)	50
A55GK	A55GKP	Kit: A55GB and A46PB	100
A57GK	A57GKP	Kit: A57GB and A46PB	100
A57CB	A57CBP	Chrome trim ring	20
BK5557GB	BK5557GBP	Cam-on mounting bracket	50

FMVSS	A P2
MATERIALS	Polycarbonate lens and housing
VOLT/AMP	12.8VDC - 0.047A
WT/DIMS	.088 lbs. / 2.5" x 2.5" x 1.063"
WARRANTY	Lifetime LED Warranty

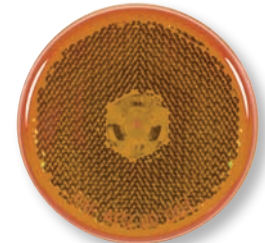

MCL59AB



MCL59RB

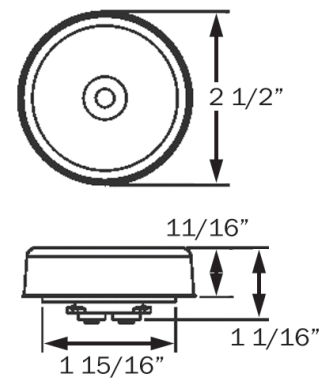

HOLE CUT-OUT: 2.75"

SEALED LED MARKER/
CLEARANCE LIGHTS



MCL190 SERIES GloLight™ Mini Thinline Sealed LED Marker/Clearance Lights



AL190AB



AL190RB



MCL190AB



MCL190RB

- Sonically sealed, waterproof
- Hard wired with female PL-10 plug on 5" leads
- Includes both lead and ground wire for mounting to all surfaces

BULK P/N	POLYPACK P/N	DESCRIPTION	QTY
YELLOW - 8 DIODES			
AL190AB	AL190ABP	Light only, female PL-10 plug	50
MCL190AB	MCL190ABP	Kit with chrome base, female PL-10 plug	50
RED - 8 DIODES			
AL190RB	AL190RBP	Light only, female PL-10 plug	50
MCL190RB	MCL190RBP	Kit with chrome base, female PL-10 plug	50
ACCESSORIES			
A91BOB	A91BOBP	Black base, open back	100
A91OB	A91OBP	Chrome base, open back	100
A91GB	A91GBP	Grommet	100
A82BB	A82BBP	Black base, open back (use with A90CB)	50
A90CB	A90CBP	Chrome cover for A82BB	50

FMVSS	P2
MATERIALS	Polycarbonate lens and housing
VOLT/AMP	12.8VDC - 0.16A
WT/DIMS	.044 lbs. / 2.625" x 1.25" x .875"
WARRANTY	Lifetime LED Warranty

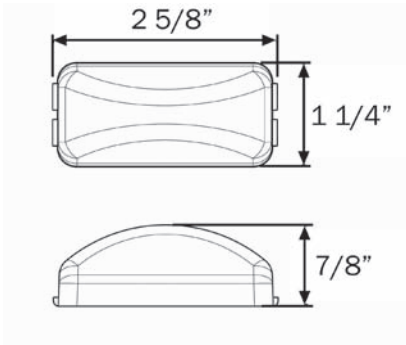

AL91 SERIES

Mini Thinline Sealed LED Marker/Clearance Lights



- Sonically sealed, waterproof
- Standard models accept standard 1- or 2-wire plugs
- Hard wired design available in 1- and 2-wire models
- Single wire design grounds through mounting hardware
- Two-wire design includes both lead and ground wire for mounting to all surfaces
- PC rated light functions as both clearance and side marker light when properly mounted on a 45 degree angle

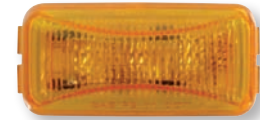

AL91AB



AL91RB

BULK P/N	POLYPACK P/N	DESCRIPTION	QTY
YELLOW - 3 DIODES			
AL91AB	AL91ABP	PC rated	50
AL91CAB	AL91CABP	PC rated, clear lens	50
MCL91AB	MCL91ABP	Kit: AL91AB, A91CB & A91LW	50
AL82AB	AL82ABP	PC rated, hard wired, 2-wire	50
AL82CAB	-	PC rated, hard wired, 2-wire, clear lens	50
MCL96AB	MCL96ABP	P2 rated kit, hard wired, 1-wire, black base	50
RED - 3 DIODES			
AL91RB	AL91RBP	PC rated	50
MCL91RB	MCL91RBP	Kit: AL91RB, A91CB & A91LW	50
AL82RB	AL82RBP	PC rated, hard wired, 2-wire	50
AL82CRB	-	PC rated, hard wired, 2-wire, clear lens	50
MCL96RB	MCL96RBP	P2 rated kit, hard wired, 1-wire, black base	50
ACCESSORIES			
A46PB	A46PBP	2-wire PL-10 plug, 6" lead	100
A86PB	A86PBP	2-wire PL-10 plug, 18" lead	100
A91LW	A91LWP	1-wire plug, 12" lead	100
A91BB	A91BBP	Black base, self grounding	100
A91BOB	A91BOBP	Black base, open back	100
A91CB	A91CBP	Chrome base, self grounding	100
A91OB	A91OBP	Chrome base, open back	100
A91GB	A91GBP	Grommet	100
A82BB	A82BBP	Black base, open back (use with A90CB)	50
A90CB	-	Chrome cover for A82BB	50
RETAIL			
MCL91AK		Yellow P2 kit with A91CB & A91LW, clam	12
MCL90AS		Yellow P2 light only, clam	12
MCL91RK		Red P2 kit with A91CB & A91LW, clam	12
MCL90RS		Red P2 light only, clam	12

FMVSS	PC (unless noted)
MATERIALS	Polycarbonate lens and housing
VOLT/AMP	12.8VDC - 0.051A
WT/DIMS	.088 lbs. 2.5" x 1.25" x 1"
WARRANTY	Lifetime LED Warranty

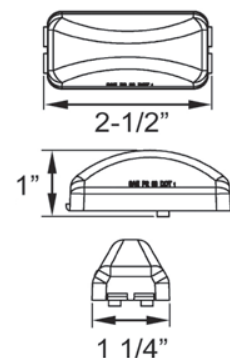

SEALED LED MARKER/
CLEARANCE LIGHTS



AL90AB



AL90RB

AL90 SERIES FLEET Count™ Mini Thinline Sealed LED Marker/Clearance Lights

- Sonically sealed, waterproof
- Accept standard 1- or 2-wire plugs
- Single wire design grounds through mounting hardware
- Two-wire design includes both lead and ground wire for mounting to all surfaces

BULK P/N	POLYPACK P/N	DESCRIPTION	QTY
----------	--------------	-------------	-----

YELLOW - 1 DIODE

AL90AB	AL90ABP	Light only	50
--------	---------	------------	----

RED - 1 DIODE

AL90RB	AL90RBP	Light only	50
--------	---------	------------	----

ACCESSORIES

A46PB	A46PBP	2-wire PL-10 plug, 6" lead	100
-------	--------	----------------------------	-----

A86PB	A86PBP	2-wire PL-10 plug, 18" lead	100
-------	--------	-----------------------------	-----

A91LW	A91LWP	1-wire plug, 12" lead	100
-------	--------	-----------------------	-----

A91BB	A91BBP	Black base, self grounding	100
-------	--------	----------------------------	-----

A91BOB	A91BOBP	Black base, open back	100
--------	---------	-----------------------	-----

A91CB	A91CBP	Chrome base, self grounding	100
-------	--------	-----------------------------	-----

A91OB	A91OBP	Chrome base, open back	100
-------	--------	------------------------	-----

A91GB	A91GBP	Grommet	100
-------	--------	---------	-----

A82BB	A82BBP	Black base, open back (use with A90CB)	50
-------	--------	--	----

A90CB	A90CBP	Chrome cover for A82BB	50
-------	--------	------------------------	----

RETAIL

AL90AK		Yellow kit with A91BB & A91LW, clam	12
--------	---	-------------------------------------	----

AL90AS		Yellow light only, clam	12
--------	--	-------------------------	----

AL90RK		Red kit with A91BB & A91LW, clam	12
--------	--	----------------------------------	----

AL90RS		Red light only, clam	12
--------	--	----------------------	----

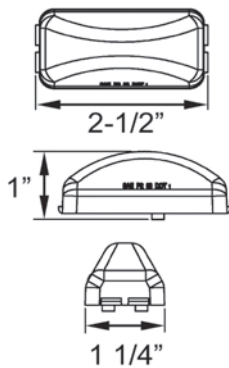

FMVSS	P2
MATERIALS	Polycarbonate lens and housing
VOLT/AMP	12.8VDC - 0.023A
WT/DIMS	.044 lbs. / 2.5" x 1.25" x 1"
WARRANTY	Lifetime LED Warranty

MCL165 SERIES GloLight™ Thinline Sealed LED Marker/Clearance Lights



- Sonically sealed, waterproof
- Accept standard 1- or 2-wire plugs
- Single wire design grounds through mounting hardware
- Two-wire design includes both lead and ground wire for mounting to all surfaces

BULK P/N	POLYPACK P/N	DESCRIPTION	QTY
YELLOW - 10 DIODES			
MCL165AB	MCL165ABP	Light only	20
RED - 10 DIODES			
MCL165RB	MCL165RBP	Light only	20
ACCESSORIES			
A65B	A65BP	Black bracket	50
A65P	A65PP	Single wire plug, .156 male bullet	50
A65PB	A65PBP	Kit: A65B black bracket & A65P plug	50
A66PB	A66PBP	Kit: Gray bracket & A65P plug	50
A67CB	A67CBP	Kit: Chrome bracket & A65P plug	50
A68PB	A68PBP	Kit: Black bracket & 2-wire plug	50

For more details on mounting and wiring accessories, see Accessories section at back of catalog.

FMVSS	P2
MATERIALS	Polycarbonate lens and housing
VOLT/AMP	12.8VDC - 0.09A
WT/DIMS	.066 lbs. / 3.875" x 1.25" x 1"
WARRANTY	Lifetime LED Warranty

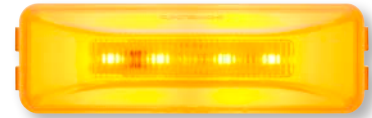

MCL165AB



MCL165RB

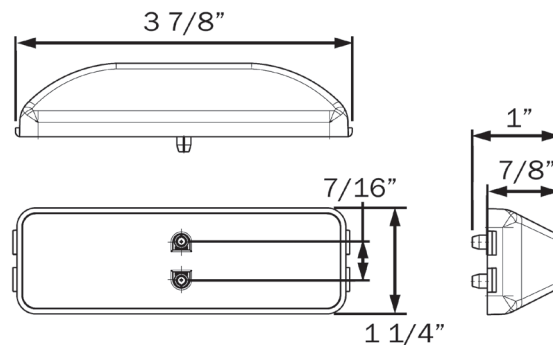

SEALED LED MARKER/
CLEARANCE LIGHTS



MCL65 SERIES Thinline Sealed LED Marker/Clearance Lights



MCL65AB



MCL65CAB



MCL65CRB



MCL65RB

- Sonically sealed, waterproof
- Accept standard 1- or 2-wire plugs
- Single wire design grounds through mounting hardware
- Two-wire design includes both lead and ground wire for mounting to all surfaces

BULK P/N	POLYPACK P/N	DESCRIPTION	QTY
YELLOW			
MCL65AB	MCL65ABP	12V, 3 diodes	20
MCL65A24B	MCL65A24BP	24V, 3 diodes	20
MCL65CAB	MCL65CABP	12V, 6 diodes, clear lens	20
MCL67AB	MCL67ABP	12V, 6-diodes, kit with A65PB	20
MCL75AB	MCL75ABP	12V, 4 diodes	20
MCL77AB	MCL77ABP	12V, 4 diodes, kit with A65PB	20
RED			
MCL65RB	MCL65RBP	12V, 3 diodes	20
MCL65R24B	MCL65R24BP	24V, 3 diodes	20
MCL65CRB	MCL65CRBP	12V, 6 diodes, clear lens	20
MCL67RB	MCL67RBP	12V, 6-diodes, kit with A65PB	20
MCL75RB	MCL75RBP	12V, 4 diodes	20
MCL77RB	MCL77RBP	12V, 4 diodes, kit with A65PB	20
ACCESSORIES			
A65B	A65BP	Black bracket	50
A65P	A65PP	Single wire plug, .156 male bullet	50
A65PB	A65PBP	Kit: A65B black bracket & A65P plug	50
A66PB	A66PBP	Kit: Gray bracket & A65P plug	50
A67CB	A67CBP	Kit: Chrome bracket & A65P plug	50
A68PB	A68PBP	Kit: Black bracket & 2-wire plug	50

For more details on mounting and wiring accessories, see Accessories section at back of catalog.

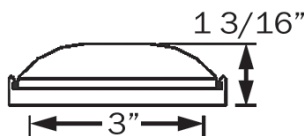
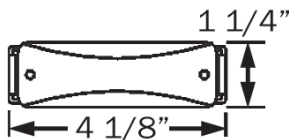

FMVSS	P2
MATERIALS	Polycarbonate lens and housing
VOLT/AMP	12.8VDC - 0.048A
WT/DIMS	.066 lbs. / 3.938" x 1.25" x 1.25"
WARRANTY	Lifetime LED Warranty

MCL61 SERIES

FLEET Count™ Thinline Sealed LED Marker/Clearance Lights

- Sonically sealed, waterproof
- Accept standard 1- or 2-wire plugs
- Single wire design grounds through mounting hardware
- Two-wire design includes both lead and ground wire for mounting to all surfaces

BULK P/N	POLYPACK P/N	DESCRIPTION	QTY
YELLOW - 2 DIODES			
MCL61AB	MCL61ABP	Light only	20
RED - 2 DIODES			
MCL61RB	MCL61RBP	Light only	20
ACCESSORIES			
A65B	A65BP	Black bracket	50
A65P	A65PP	Single wire plug, .156 male bullet	50
A65PB	A65PBP	Kit: A65B black bracket & A65P plug	50
A66PB	A66PBP	Kit: Gray bracket & A65P plug	50
A67CB	A67CBP	Kit: Chrome bracket & A65P plug	50
A68PB	A68PBP	Kit: Black bracket & 2-wire plug	50
For more details on mounting and wiring accessories, see Accessories section at back of catalog.			
RETAIL			
MCL61AK		Yellow kit with A65PB, clam	12
MCL61AS		Yellow light only, clam	12
MCL61RK		Red kit with A65PB, clam	12
MCL61RS		Red light only, clam	12

FMVSS	P2
MATERIALS	Polycarbonate lens and housing
VOLT/AMP	12.8VDC - 0.051A
WT/DIMS	.066 lbs. / 4" x 1.25" x 1"
WARRANTY	Lifetime LED Warranty

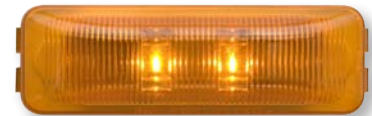

MCL61AB



MCL61RB

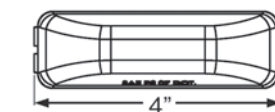

SEALED LED MARKER/
CLEARANCE LIGHTS



MCL63 SERIES

Miro-Flex™ Thinline Sealed LED Marker/Clearance Lights

- Sonically sealed, waterproof
- Accept standard 1- or 2-wire plugs
- Single wire design grounds through mounting hardware
- Two-wire design includes both lead and ground wire for mounting to all surfaces

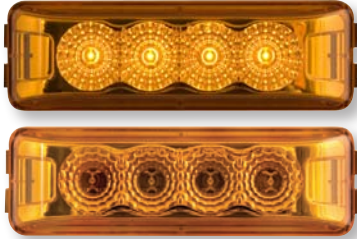

MCL63AB



MCL63CAB



MCL63CRB



MCL63RB

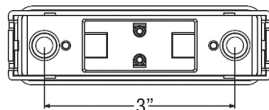
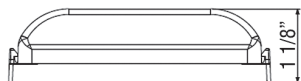
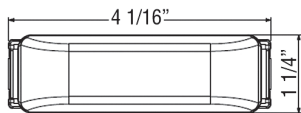

BULK P/N	POLYPACK P/N	DESCRIPTION	QTY
YELLOW - 4 DIODES			
MCL63AB	MCL63ABP	Light only	20
MCL63CAB	MCL63CABP	Light only, clear lens	20
RED - 4 DIODES			
MCL63RB	MCL63RBP	Light only	20
MCL63CRB	MCL63CRBP	Light only, clear lens	20
ACCESSORIES			
A65B	A65BP	Black bracket	50
A65P	A65PP	Single wire plug, .156 male bullet	50
A65PB	A65PBP	Kit: A65B black bracket & A65P plug	50
A66PB	A66PBP	Kit: Gray bracket & A65P plug	50
A67CB	A67CBP	Kit: Chrome bracket & A65P plug	50
A68PB	A68PBP	Kit: Black bracket & 2-wire plug	50

For more details on mounting and wiring accessories, see Accessories section at back of catalog.

FMVSS	P2
MATERIALS	Polycarbonate lens and housing
VOLT/AMP	12.8VDC - 0.051A
WT/DIMS	.066 lbs. / 4" x 1.25" x 1"
WARRANTY	Lifetime LED Warranty

MCL61/65 SERIES

Thinline Sealed LED Fender Lights

- Sonically sealed, waterproof
- Accept standard 1- or 2-wire plugs
- Single wire design grounds through mounting hardware
- Two-wire design includes both lead and ground wire for mounting to all surfaces

BULK P/N	POLYPACK P/N	DESCRIPTION	QTY
DUAL RED/YELLOW - 10 DIODES			
MCL65ARB	MCL65ARBP	Light only	20
MCL65CARB	MCL65CARBP	Light only, clear lens	20
MCL67ARB	MCL67ARBP	Kit with A65PB bracket & plug	20
DUAL RED/YELLOW - 2 DIODES			
MCL61ARB	MCL61ARBP	Light only	20
MCL61AR26BK	-	Kit with A67BB black base & 26" power wire with .150 male bullet	20
ACCESSORIES			
A67BB	A67BBP	Black fender bracket	50
A67GB	A67GBP	Gray fender bracket	50
A67CVB	A67CVBP	Curved fender bracket, gray	50
A65B	A65BP	Black bracket	50
A65P	A65PP	Single wire plug, .156 male bullet	50
A65PB	A65PBP	Kit: A65B black bracket & A65P plug	50
A66PB	A66PBP	Kit: Gray bracket & A65P plug	50
A67CB	A67CBP	Kit: Chrome bracket & A65P plug	50
A68PB	A68PBP	Kit: Black bracket & 2-wire plug	50

For more details on mounting and wiring accessories, see Accessories section at back of catalog.

FMVSS	P2
MATERIALS	Polycarbonate lens and housing
VOLT/AMP	12.8VDC - 0.048A
WT/DIMS	.066 lbs. / 3.875" x 1.25" x 0.875"
WARRANTY	Lifetime LED Warranty

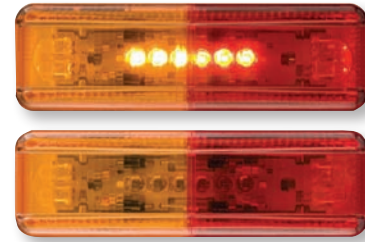

MCL65ARB



MCL61ARB

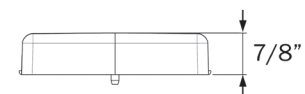
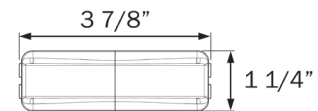

light only

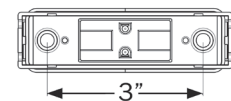
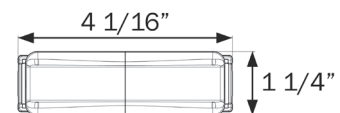

light with base

SEALED LED MARKER/
CLEARANCE LIGHTS



MCL13 SERIES Mini Sealed LED Marker/Clearance Lights



MCL13A2B



MCL13CA2B



MCL13CR2B



MCL13R2B



UCL13C2PG

- Sonically sealed, waterproof
- Surface mount installation
- Single wire design grounds through mounting hardware
- Two-wire design includes both lead and ground wire for mounting to all surfaces
- Available in red, yellow, and clear utility light

BULK P/N	POLYPACK P/N	DESCRIPTION	QTY
YELLOW - 2 DIODES			
MCL13A2B	MCL13A2BP	2-wire	20
MCL13CA2B	MCL13CA2BP	2-wire, clear lens	20
MCL13A2MB	-	2-wire, .156 male bullets	20
MCL131A2B	MCL131A2BP	1-wire	20
RED - 2 DIODES			
MCL13R2B	MCL13R2BP	2-wire	20
MCL13CR2B	MCL13CR2BP	2-wire, clear lens	20
MCL13R2MB	-	2-wire, .156 male bullets	20
MCL131R2B	MCL131R2BP	1-wire	20
UTILITY LIGHTS - 2 DIODES			
UCL13C2PG	UCL13C2PGP	White LED 2-wire, .180 female barrels	20
ACCESSORIES			
A13C2B	A13C2BP	Chrome base/bezel	100
A13B2B	A13B2BP	Black base/bezel	100
A13G2B	A13G2BP	Gasket	200
RETAIL			
MCL13ATRS		Yellow, 2-wire, chrome bezel	12
MCL13AS		Yellow 2-wire light only	12
MCL13RTRS		Red, 2-wire, chrome bezel	12
MCL13RS		Red 2-wire light only	12

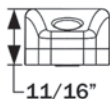
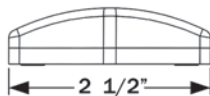
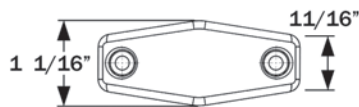

FMVSS	P2 P3 (except UCL13)
MATERIALS	Polycarbonate lens and housing
VOLT/AMP	12.8VDC - 0.046A
WT/DIMS	.088 lbs. / 2.5" x 1.063" x 0.688"
WARRANTY	Lifetime LED Warranty

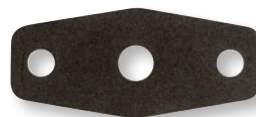

A13G2B

MCL14 SERIES

Mini Sealed LED Horizontal-Vertical Marker/Clearance Lights

- Sonically sealed, waterproof
- Surface mount installation at either horizontal or vertical
- Single wire design grounds through mounting hardware
- Two-wire design includes both lead and ground wire for mounting to all surfaces
- Available in red, yellow, and clear lens

BULK P/N	POLYPACK P/N	DESCRIPTION	QTY
YELLOW - 2 DIODES			
MCL14AB	MCL14ABP	2-wire	20
MCL14ABF	MCL14ABFP	2-wire, female plug	20
MCL14AGB	MCL14AGBP	1-wire, self grounding	20
MCL14AGPB	MCL14AGPBP	1-wire, .180 male bullet	20
MCL14CABF	MCL14CABFP	Clear lens, 2-wire, .156 female barrels	20
RED - 2 DIODES			
MCL14RB	MCL14RBP	2-wire	20
MCL14RBF	MCL14RBFP	2-wire, female plug	20
MCL14RGB	MCL14RGBP	1-wire, self grounding	20
MCL14CRBF	MCL14CRBFP	Clear lens, 2-wire, .156 female barrels	20
ACCESSORIES			
A13C2B	A13C2BP	Chrome base/bezel	100
A13B2B	A13B2BP	Black base/bezel	100
A13G2B	A13G2BP	Gasket	200

FMVSS	P2 PC
MATERIALS	Polycarbonate lens and housing
VOLT/AMP	12.8VDC - 0.06A
WT/DIMS	.088 lbs. / 2.5" x 1.125" x 0.625"
WARRANTY	Lifetime LED Warranty



MCL14AB



MCL14CABF



MCL14CRBF



MCL14 clear lens, unlit



MCL14RB

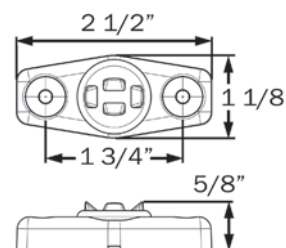



MCL15 SERIES Surface Mount LED Marker/Clearance Light Kits



MCL15APG



MCL15AKPG



MCL15RPG



MCL15RKPG

- Sonically sealed, waterproof
- Surface mount installation
- Hard wired, includes both lead and ground wire with molded .180 male bullets
- Chrome finish ABS trim ring included with kits

BULK P/N	POLYPACK P/N	DESCRIPTION	QTY
YELLOW - 2 DIODES			
MCL15APG	MCL15APGP	Light only, .180 male bullets	20
MCL15AKPG	MCL15AKPGP	Kit: MCL15APG, chrome trim ring	20
RED - 2 DIODES			
MCL15RPG	MCL15RPGP	Light only, .180 male bullets	20
MCL15RKPG	MCL15RKPGP	Kit: MCL15RPG, chrome trim ring	20
ACCESSORIES			
A15CB	A15CBP	Chrome base/bezel	100
A15BB	A15BBP	Black base/bezel	100
A15GB	A15GBP	Gasket	50

FMVSS	P2
MATERIALS	Polycarbonate lens and housing, ABS trim ring
VOLT/AMP	12.8VDC - 0.047A
WT/DIMS	Light: .088 lbs. / 2.625" x 1.375" x .563" Kit: .092 lbs. / 3.938" x 1.344" x .688"
WARRANTY	Lifetime LED Warranty

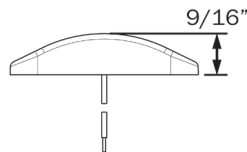
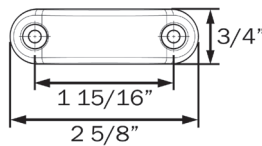

MCL15APG/RPG

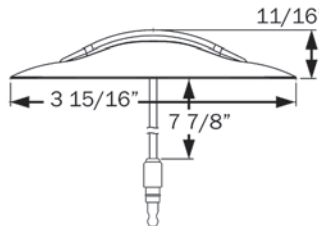
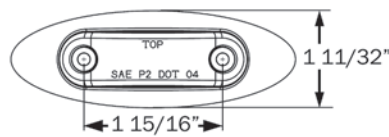

MCL15AKPG/RKPG

MCL17/19 SERIES

Miro-Flex™ Surface Mount Sealed LED Marker/Clearance Lights

- Sonically sealed, waterproof
- Two-wire design includes both lead and ground wire for mounting to all surfaces
- Snap-on chrome trim ring included
- Available in 3-LED 4" model and 4-LED 6" model

BULK P/N	POLYPACK P/N	DESCRIPTION	QTY
YELLOW			
MCL17AB	MCL17ABP	3-LED	20
MCL17APG	MCL17APGP	3-LED, female PL-10 plug	20
MCL17CAB	MCL17CABP	3-LED, clear lens	20
MCL19AB	MCL19ABP	4-LED	20
MCL19CAB	MCL19CABP	4-LED, clear lens	20
RED			
MCL17RB	MCL17RBP	3-LED	20
MCL17RPG	MCL17RPGP	3-LED, female PL-10 plug	20
MCL17CRB	MCL17CRBP	3-LED, clear lens	20
MCL19RB	MCL19RBP	4-LED	20
MCL19CRB	MCL19CRBP	4-LED, clear lens	20
ACCESSORIES			
A17GB	A17GBP	Black gasket for 3-LED models	100

FMVSS	P2
MATERIALS	Polycarbonate lens and housing
VOLT/AMP	MCL17: 12.8VDC - 0.047A MCL19: 12.8VDC - 0.051A
WT/DIMS	MCL17: .088 lbs. / 4.188" x 1.375" x .75" MCL19: .132 lbs. / 5.75" x 1.563" x .75"
WARRANTY	Lifetime LED Warranty

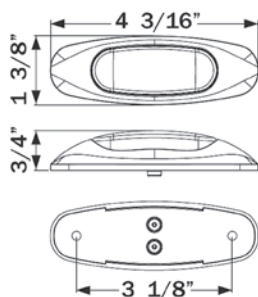

MCL17

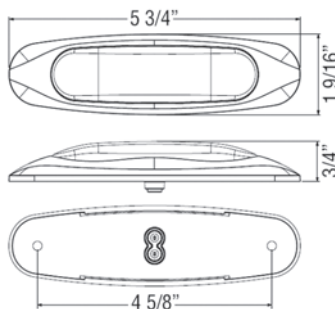

MCL19



MCL17AB



MCL17CAB/CRB



MCL17RB



MCL19AB



MCL19CAB/CRB



MCL19RB



A17GB



MCL31AB



MCL31RB

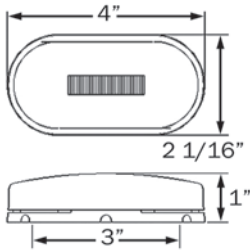

MCL31 SERIES

Surface Mount LED Marker/ Clearance Lights with Reflex

- Snap-on, replaceable lens
- Surface mount white base, mounts on 3" centers
- Lens with reflex eliminates need for separate reflector
- Two-wire design includes both lead and ground wire for mounting to all surfaces

BULK P/N	POLYPACK P/N	DESCRIPTION	QTY
YELLOW - 6 DIODES			
MCL31AB	MCL31ABP	Light only	20
RED - 6 DIODES			
MCL31RB	MCL31RBP	Light only	20
FMVSS	A P2		
MATERIALS	Acrylic lens, ABS housing		
VOLT/AMP	12.8VDC - 0.040A		
WT/DIMS	.132 lbs. / 4" x 2.063" x 1"		
WARRANTY	Lifetime LED Warranty		



MCL32AB



MCL32RB

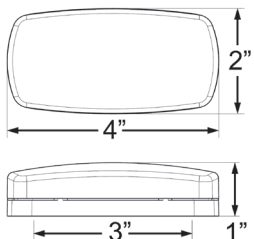

MCL32 SERIES

Surface Mount LED Marker/ Clearance Lights with Reflex

- Snap-on, replaceable lens
- Surface mount white base, mounts on 3" centers
- Lens with reflex eliminates need for separate reflector
- Two-wire design includes both lead and ground wire for mounting to all surfaces

BULK P/N	POLYPACK P/N	DESCRIPTION	QTY
YELLOW - 3 DIODES			
MCL32AB	MCL32ABP	Light with white base	100
MCL32ABB	MCL32ABBP	Light with black base	100
RED - 3 DIODES			
MCL32RB	MCL32RBP	Light with white base	100
MCL32RBB	MCL32RBBP	Light with black base	100
FMVSS	A P2		
MATERIALS	Acrylic lens, ABS housing		
VOLT/AMP	12.8VDC - 0.2A		
WT/DIMS	.132 lbs. / 4" x 2" x 1"		
WARRANTY	Lifetime LED Warranty		

MCL35A32G

Surface Mount LED Marker/Clearance Light with Reflex

- Screw-on, replaceable lens
- Surface mount black base, mounts on 3-5/16" centers
- Lens with reflex eliminates need for separate reflector
- Self grounding; 32" power wire with .180 male bullet



MCL35A32G

BULK P/N	POLYPACK P/N	DESCRIPTION	QTY
YELLOW - 6 DIODES			
MCL35A32G	MCL35A32GP	Light, 32" lead with .180 male bullet	50
ACCESSORIES			
AL36AB	AL36ABP	Yellow replacement lens	50
FMVSS	A P2		
MATERIALS	Acrylic lens, ABS housing		
VOLT/AMP	12.8VDC - 0.165A		
WT/DIMS	.110 lbs. / 3.875" x 2.375" x 0.938"		
WARRANTY	Lifetime LED Warranty		

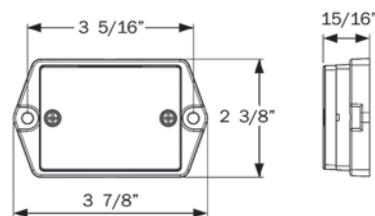

MCL36 SERIES

Stud Mount LED Marker/Clearance Light with Reflex

- Stud mount black base; two-wire design
- Lens with reflex eliminates need for separate reflector



MCL36AB



MCL36RB

BULK P/N	POLYPACK P/N	DESCRIPTION	QTY
YELLOW - 6 DIODES			
MCL36AB	MCL36ABP	Hard wired	20
MCL36APG	MCL36APGP	Hard wired, .180 male bullets	20
RED - 6 DIODES			
MCL36RB	MCL36RBP	Hard wired	20
RETAIL			
MCL36AS	Retail Ready	Yellow light with hardware, clam	12

FMVSS	A P2		
MATERIALS	Acrylic lens, ABS housing		
VOLT/AMP	12.8VDC - 0.054A		
WT/DIMS	.110 lbs. / 2.875" x 2.125" x .938"		
WARRANTY	Lifetime LED Warranty		

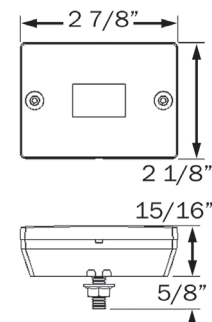



MCL40/44AB



MCL40/44RB



A44GB

MCL40/44 SERIES

Surface Mount LED Marker/ Clearance Lights with Reflex

- Select from 2-LED and 6-LED models in amber and red
- Snap-on, replaceable lens
- Surface mount white base, mounts on 3" centers
- Lens with reflex eliminates need for separate reflector
- Single wire and two-wire designs available

BULK P/N	POLYPACK P/N	DESCRIPTION	QTY
YELLOW			
MCL40AB	MCL40ABP	2-LED, 2-wire, power and ground	20
MCL40AB1	-	2-LED, 1-wire, self grounding	20
MCL44AB	MCL44ABP	6-LED, 2-wire, power and ground	20
MCL44AB1	MCL44AB1P	6-LED, 1-wire, self grounding	20
RED			
MCL40RB	MCL40RBP	2-LED, 2-wire, power and ground	20
MCL40RB1	-	2-LED, 1-wire, self grounding	20
MCL44RB	MCL44RBP	6-LED, 2-wire, power and ground	20
MCL44RB1	MCL44RB1P	6-LED, 1-wire, self grounding	20
ACCESSORIES			
A44GB	-	Mounting gasket, white	100
A44GTB	-	Mounting gasket, thick, white	1000

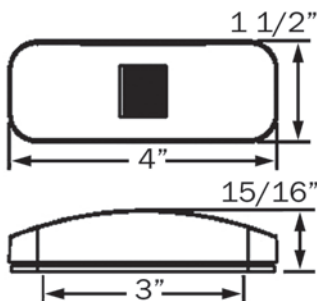

FMVSS	P2 A
MATERIALS	Acrylic lens, ABS housing
VOLT/AMP	12.8VDC - 2-LED 0.040A; 6-LED .054A
WT/DIMS	.088 lbs. / 4" x 1.5" x 0.938"
WARRANTY	Lifetime LED Warranty

MCL45/46 SERIES LED Double Bullseye Style Marker/Clearance Lights



- Snap-on, replaceable lens
- Surface mount white base, mounts on 3" centers
- Single wire and two-wire designs available

BULK P/N	POLYPACK P/N	DESCRIPTION	QTY
YELLOW - 10 DIODES			
MCL45AB	MCL45ABP	1-wire, self grounding	20
MCL46AB	MCL46ABP	2-wire, power and ground	20
RED - 10 DIODES			
MCL45RB	MCL45RBP	1-wire, self grounding	20
MCL46RB	MCL46RBP	2-wire, power and ground	20
ACCESSORIES			
AL46AB	AL46ABP	Yellow replacement lens	50
AL46RB	AL46RBP	Red replacement lens	10

FMVSS	P2 PC
MATERIALS	Acrylic lens, ABS housing
VOLT/AMP	12.8VDC - 0.087A
WT/DIMS	.088 lbs. / 4.063" x 2.125" x 1.125"
WARRANTY	Lifetime LED Warranty



MCL45/46AB



MCL45/46RB

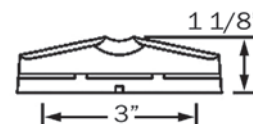

MCL49AB Surface Mount Sealed LED Marker/Clearance Light



- Sonically sealed, waterproof
- Surface mount, mounts on 3" centers
- Includes both lead and ground wire

BULK P/N	POLYPACK P/N	DESCRIPTION	QTY
YELLOW - 14 DIODES			
MCL49AB	MCL49ABP	Light only	20

FMVSS	P2 PC
MATERIALS	Polycarbonate lens and housing
VOLT/AMP	12.8VDC - 0.87A
WT/DIMS	.132 lbs. / 3.875" x 2" x 1"
WARRANTY	Lifetime LED Warranty



MCL49AB

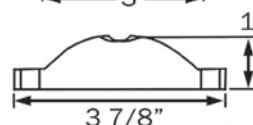
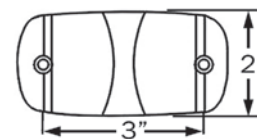



MCL48AB



MCL48CAB

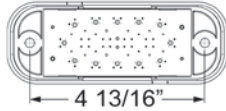
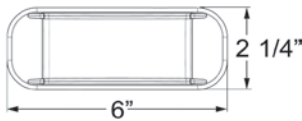

MCL73AB

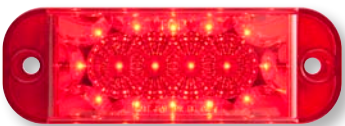

MCL73RB



MCL48 SERIES

LED Intermediate Side Marker Light with Supplemental Mid-Ship Turn

- Sonically sealed, waterproof
- Surface mount, mounts on 4-13/16" centers
- Includes both lead and ground wires

BULK P/N	POLYPACK P/N	DESCRIPTION	QTY
YELLOW - 16 DIODES			
MCL48AB	MCL48ABP	Light	20
MCL48CAB	MCL48CABP	Light, clear lens	20
ACCESSORIES			
A48CB	A48CBP	Chrome bezel	50
FMVSS	P2		
MATERIALS	Polycarbonate lens and housing		
VOLT/AMP	12.8VDC - Side marker .074A; Turn signal .248A		
WT/DIMS	.221 lbs. / 6" x 2.25" x 1.375"		
WARRANTY	Lifetime LED Warranty		

MCL73 SERIES

LED Surface Mount Marker/Clearance Lights



- Sonically sealed, waterproof
- Surface mount, mounts on 4-13/16" centers
- Includes both lead and ground wires

BULK P/N	POLYPACK P/N	DESCRIPTION	QTY
YELLOW - 16 DIODES			
MCL73AB	MCL73ABP	Light	20
RED - 16 DIODES			
MCL73RB	MCL73RBP	Light	20
ACCESSORIES			
A48CB	A48CBP	Chrome bezel	50
FMVSS	P2 PC		
MATERIALS	Polycarbonate lens and housing		
VOLT/AMP	12.8VDC - .248A		
WT/DIMS	.221 lbs. / 6" x 2.25" x 1.375"		
WARRANTY	Lifetime LED Warranty		

MCL66 SERIES Sealed LED Surface Mount Marker/Clearance Lights

- Sonically sealed, waterproof
- Surface mount, mounts on 3" centers
- Includes both lead and ground wire

BULK P/N	POLYPACK P/N	DESCRIPTION	QTY
YELLOW - 6 DIODES			
MCL66AB	MCL66ABP	12V	20
MCL66APG	MCL66APGP	12V, .180 male bullets	20
MCL66A24B	MCL66A24BP	24V	20
MCL66CAB	-	12V, clear lens	20
RED - 6 DIODES			
MCL66RB	MCL66RBP	12V	20
MCL66RPG	-	12V, .180 male bullets	20
MCL66R24B	MCL66R24BP	24V	20
MCL66CRB	-	12V, clear lens	20
ACCESSORIES			
BK66DB	BK66DBP	Armored base, die cast metal	50
A66GB	A66GBP	Mounting gasket, black	100
FMVSS	P2		
MATERIALS	Polycarbonate lens and housing		
VOLT/AMP	12.8VDC - 0.057A		
WT/DIMS	.088 lbs. / 4" x .875" x 1.188"		
WARRANTY	Lifetime LED Warranty		



MCL66AB

MCL66CAB

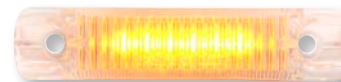

MCL66CRB



MCL66RB

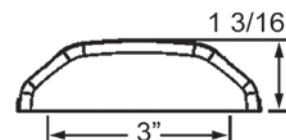

MCL71 SERIES Low Profile LED Marker/ Clearance Lights

- Chrome plated housing, replaceable lens
- Includes both lead and ground wire

BULK P/N	POLYPACK P/N	DESCRIPTION	QTY
RED - 2 DIODES			
MCL71RB	MCL71RBP	Flush mount marker light	20
FMVSS	P2		
MATERIALS	Acrylic lens, chrome plated ABS bezel		
VOLT/AMP	12.8VDC - 0.054A		
WT/DIMS	.088 lbs. / 3.75" x 2.25" x 1/2"		
WARRANTY	Lifetime LED Warranty		



MCL71RB

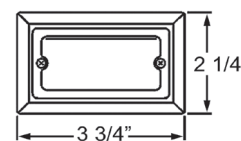

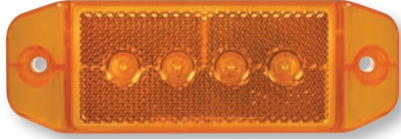

MCL76AB



MCL76RB

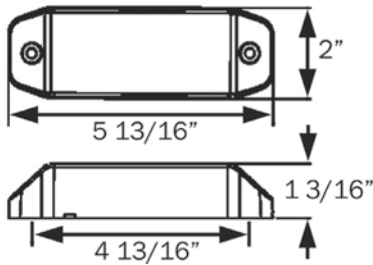

MCL76 SERIES

Sealed LED Surface Mount Marker/ Clearance Lights with Reflex

- Sonically sealed, waterproof
- Surface mount, mounts on 4-13/16" centers
- Lens with reflex eliminates need for a separate reflector
- Includes both lead and ground wire

BULK P/N	POLYPACK P/N	DESCRIPTION	QTY
YELLOW - 4 DIODES			
MCL76AB	MCL76ABP	Light with reflex	20
RED - 4 DIODES			
MCL76RB	MCL76RBP	Light with reflex	20

FMVSS	A P2
MATERIALS	Polycarbonate lens and housing
VOLT/AMP	12.8VDC - 0.063A
WT/DIMS	.132 lbs. / 5.813" x 2" x 1.188"
WARRANTY	Lifetime LED Warranty



MCL85AB

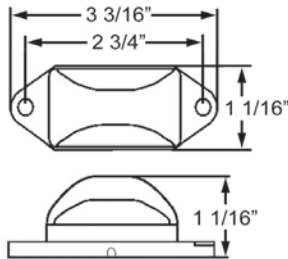

MCL85 SERIES

Sealed LED Surface Mount Amber Marker/Clearance Lights

- Sonically sealed, waterproof
- Surface mount, mounts on 2-3/4" centers
- Single wire design grounds through mounting hardware

BULK P/N	POLYPACK P/N	DESCRIPTION	QTY
YELLOW - 3 DIODES			
MCL85AB	MCL85ABP	Surface mount light	50

FMVSS	P2 P3
MATERIALS	Polycarbonate lens and housing
VOLT/AMP	12.8VDC - 0.066A
WT/DIMS	.044 lbs. / 3.188" x 1.063" x 1.188"
WARRANTY	Lifetime LED Warranty

MCL81 SERIES

Chrome Plated LED Marker/Clearance Lights



- Chrome plated ABS housing, replaceable lens
- Includes both lead and ground wire

BULK P/N	POLYPACK P/N	DESCRIPTION	QTY
YELLOW - 6 DIODES			
MCL81AB	MCL81ABP	Light with ABS housing	20
RED - 6 DIODES			
MCL81RB	MCL81RBP	Light with ABS housing	20

FMVSS	P2 PC
MATERIALS	Acrylic lens, chrome plated ABS bezel
VOLT/AMP	12.8VDC - 0.153A
WT/DIMS	.265 lbs. / 4.781" x 2.125" x 1.375"
WARRANTY	Lifetime LED Warranty



MCL81AB



MCL81RB

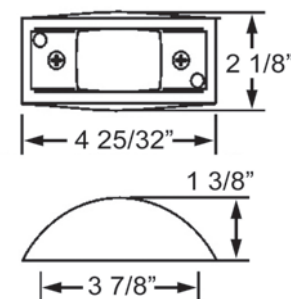

MCL86 SERIES

Armored Die Cast LED Marker/Clearance Lights



- Replaceable lens, die cast steel housing, mounting gasket
- Surface mount, mounts on 3-7/8" centers
- Two-wire design with power and ground wires

BULK P/N	POLYPACK P/N	DESCRIPTION	QTY
YELLOW - 6 DIODES			
MCL86AB	MCL86ABP	Light with steel housing	20
RED - 6 DIODES			
MCL86RB	MCL86RBP	Light with steel housing	20

FMVSS	P2 PC
MATERIALS	Acrylic lens, steel housing
VOLT/AMP	12.8VDC - 0.20A
WT/DIMS	.463 lbs. / 4.5" x 2.25" x 1.5"
WARRANTY	Lifetime LED Warranty



MCL86AB



MCL86RB

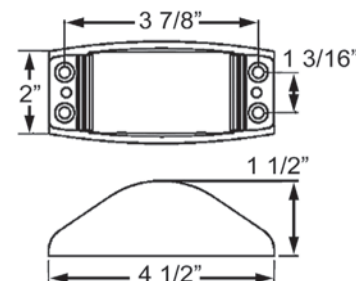



MCL95AB



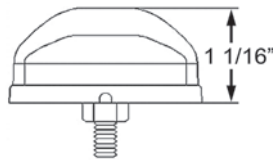
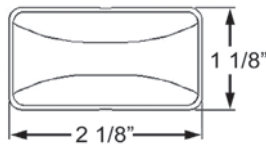

MCL95RB



MCL95 SERIES Sealed Stud Mount LED Marker/Clearance Lights

- Sonically sealed, waterproof
- Single wire design grounds through mounting hardware

BULK P/N	POLYPACK P/N	DESCRIPTION	QTY
YELLOW - 3 DIODES			
MCL95AB	MCL95ABP	1-wire, 20" lead	50
MCL95A24B	MCL95A24BP	1-wire, 24" lead	50
MCL95ABF	MCL95ABFP	2-wire, 5mm female bullets	50
RED - 3 DIODES			
MCL95RB	MCL95RBP	1-wire, 20" lead	50
MCL95RBF	MCL95RBF	2-wire, 5mm female bullets	50
RETAIL			
MCL95AS		Yellow, clam	12
MCL95RS		Red, clam	12

FMVSS	P2 P3
MATERIALS	Polycarbonate lens and housing, stainless steel base, plated steel stud
VOLT/AMP	12.8VDC - 0.051A
WT/DIMS	.088 lbs. / 2.125" x 1.125" x 1.063"
WARRANTY	Lifetime LED Warranty



CBL22AB

CBL22RB

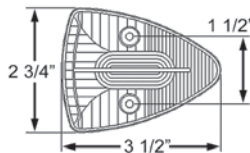

CBL22 SERIES Sealed LED Triangular Cab/Clearance Light



- Sonically sealed, waterproof
- Design includes lead and ground wire
- Mounting gasket included

BULK P/N	POLYPACK P/N	DESCRIPTION	QTY
YELLOW - 15 DIODES			
CBL22AB	CBL22ABP	Cab light	50
CBL22CAB	-	Cab light, clear lens	50
RED - 15 DIODES			
CBL22RB	CBL22RBP	Cab light	50

FMVSS	P2 PC
MATERIALS	Polycarbonate lens and housing
VOLT/AMP	12.8VDC - 0.107A
WT/DIMS	.176 lbs. / 3.5" x 2.75" x 1.688"
WARRANTY	Lifetime LED Warranty

MCL70 SERIES

Sealed LED Identification Light Bars for Over 80" Applications



- Sonically sealed, waterproof
- Ultra thin – only 5/8" thick
- Design includes both lead and ground wire



MCL70RB

MCL70RCB

BULK P/N	POLYPACK P/N	DESCRIPTION	QTY
RED ID LIGHT BAR - 3 DIODES			
MCL70RB	MCL70RBP	ID light bar	10
MCL70RBF2	-	ID light bar, .180 female barrels	10
MCL70RCB	MCL70RCBP	ID light bar, clear lens	10
ACCESSORIES			
A69CB	A69CBP	Chrome base/bezel	10
A69GB	-	Mounting gasket, black	10
RETAIL			
MCL70RS		Red, clam	20

FMVSS	P2
MATERIALS	Polycarbonate lens and housing
VOLT/AMP	12.8VDC - 0.038A
WT/DIMS	.441 lb. / 15" x 1.375" x .625"
WARRANTY	Lifetime LED Warranty

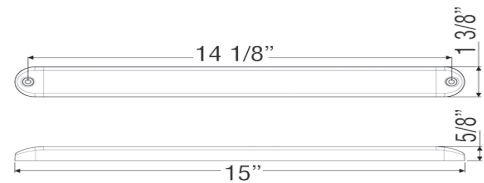

MCL78/88 SERIES

Sealed LED Identification Light Bars for Over 80" Applications



- Sonically sealed, waterproof
- Ultra thin – only 5/8" thick
- Design includes both lead and ground wire



MCL78RB

MCL88RCB

BULK P/N	POLYPACK P/N	DESCRIPTION	QTY
RED ID LIGHT BAR - 3 DIODES			
MCL78RB	MCL78RBP	ID light bar	10
MCL88RCB	MCL88RCBP	ID light bar, clear lens	10
ACCESSORIES			
A79CB	A79CBP	Chrome base/bezel	10

FMVSS	P2
MATERIALS	Polycarbonate lens and housing
VOLT/AMP	12.8VDC - 0.022A
WT/DIMS	.441 lb. / 17" x 1.375" x 1"
WARRANTY	Lifetime LED Warranty

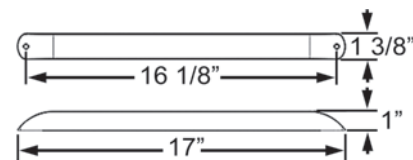



MCL83 SERIES

Sealed LED Identification Light Bar for Over 80" Applications



MCL83RB

- Sonically sealed, waterproof lights snap onto corrosion proof polycarbonate base
- Design includes both lead and ground wire

BULK P/N	POLYPACK P/N	DESCRIPTION	QTY
RED ID LIGHT BAR - 3 DIODES			
MCL83RB	MCL83RBP	3-LED ID light bar	10
AL90RB	AL90RBP	1-LED replacement light	50
RETAIL			
MCL83RK		3-LED ID light bar, slipover blister	6

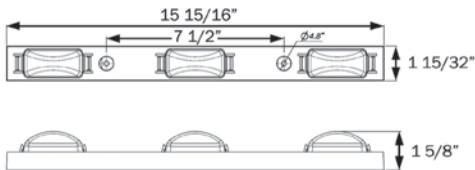

FMVSS	P2
MATERIALS	Polycarbonate lens and housing
VOLT/AMP	12.8VDC - .069A
WT/DIMS	.397 lb. / 15.938" x 1.469" x 1.625"
WARRANTY	Lifetime LED Warranty



MCL93 SERIES

Sealed LED Identification Light Bar for Over 80" Applications



MCL93RB

- Sonically sealed, waterproof lights snap onto corrosion proof polycarbonate base
- Design includes both lead and ground wire

BULK P/N	POLYPACK P/N	DESCRIPTION	QTY
RED ID LIGHT BAR - 9 DIODES			
MCL93RB	MCL93RBP	9-LED ID light bar	10
MCL93RPG	MCL93RPGP	9-LED ID light bar, .180 male bullet on power, eyelet on ground	10
AL91RB	AL91RBP	3-LED replacement light	50
RETAIL			
MCL93RK		9-LED ID light bar, slipover blister	6

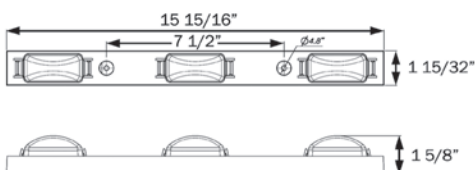

FMVSS	P2
MATERIALS	Polycarbonate lens and housing
VOLT/AMP	12.8VDC - 0.153A
WT/DIMS	.397 lb. / 15.938" x 1.469" x 1.625"
WARRANTY	Lifetime LED Warranty

MCL84 SERIES

Sealed LED Identification Light Bar for Over 80" Applications



- Sonically sealed, waterproof lights snap onto stainless steel base
- Design includes both lead and ground wire



MCL84RB

BULK P/N	POLYPACK P/N	DESCRIPTION	QTY
RED ID LIGHT BAR - 9 DIODES			
MCL84RB	MCL84RBP	9-LED ID light bar	10
AL91RB	AL91RBP	3-LED replacement light	50

FMVSS	P2
MATERIALS	Polycarbonate light, stainless steel housing
VOLT/AMP	12.8VDC - .153A
WT/DIMS	.397 lb. / 16.5" x 1.375" x 1.625"
WARRANTY	Lifetime LED Warranty

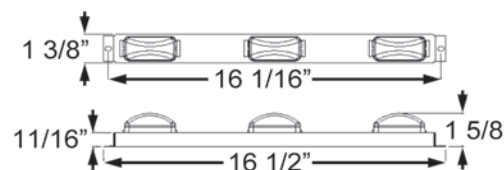

MCL97 SERIES

Sealed LED Identification Light Bar for Over 80" Applications



- Sealed, waterproof lights on stainless steel base
- Single wire, grounds through mounting hardware



MCL97RB

BULK P/N	POLYPACK P/N	DESCRIPTION	QTY
RED ID LIGHT BAR - 9 DIODES			
MCL97RB	MCL97RBP	9-LED ID light bar	10
MCL97RPG	-	9-LED ID light bar, .180 male bullet	10

RETAIL			
MCL97RK		ID light bar, slipover blister	6

FMVSS	P2 P3
MATERIALS	Polycarbonate light, stainless steel base
VOLT/AMP	12.8VDC - .153A
WT/DIMS	.287 lb. / 14.25" x 1.188" x 1.313"
WARRANTY	Lifetime LED Warranty

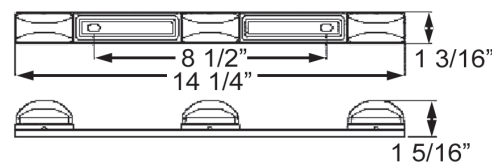



MCL98 SERIES

Sealed LED Identification Light Bar for Over 80" Applications



- Sonically sealed, waterproof
- Compact – 14.25" x 1.125"
- Design includes both lead and ground wire

MCL98RB

BULK P/N	POLYPACK P/N	DESCRIPTION	QTY
RED ID LIGHT BAR - 3 DIODES			
MCL98RB	MCL98RBP	ID light bar	10

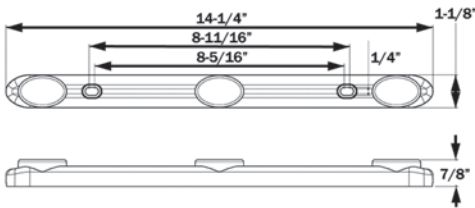

FMVSS	P2
MATERIALS	Polycarbonate lens and housing
VOLT/AMP	12.8VDC - 0.020A
WT/DIMS	.243 lb. / 14.25" x 1.125" x .875"
WARRANTY	Lifetime LED Warranty



MCL922 & MCL122/12 SERIES

Sealed 3/4" LED Identification Lights for Over 80" Applications



MCL922RB

- Sonically sealed, waterproof
- Design includes both lead and ground wire



MCL122RK3B

BULK P/N	POLYPACK P/N	DESCRIPTION	QTY
RED ID LIGHTS - 3 DIODES			
MCL922RB	MCL922RBP	ID light bar, molded black base	10
MCL12RK3B	MCL12RK3BP	(3) red MCL12 lights, molded harness	20
MCL12RK3RMB	MCL12RK3RMBP	(3) red MCL12 lights, molded harness, weathertight plug	50
MCL22RK3B	MCL22RK3BP	(3) red MCL12 lights, molded harness, supplemental turn function	50
MCL122RK3B	MCL122RK3BP	(3) red MCL112 lights, molded harness	20
MCL112RB	MCL112RBP	GloLight™ replacement light	50
MCL12RB	MCL12RBP	Single diode replacement light	50

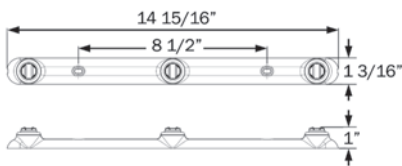

MCL922RB

FMVSS	P2
MATERIALS	Polycarbonate lens and housing
VOLT/AMP	12.8VDC - 0.022A
WT/DIMS	MCL922RB: .441 lb. / 14.875" x 1.25" x 1"
WARRANTY	Lifetime LED Warranty

LPL12 SERIES

3/4" Sealed LED License Light



- Sealed, waterproof
- Meets SAE J587 when properly mounted using brackets listed below
- Design includes both lead and ground wire



LPL12CB

BULK P/N	POLYPACK P/N	DESCRIPTION	QTY
LICENSE LIGHT - 2 DIODES			
LPL12CB	LPL12CBP	Light with .180 female barrels	20
LPL12CPGB	-	Light with .180 male bullets	20
LPL12CKM2B	-	Kit: LPL12CPGB, A12B2LPB surface mount bracket, A12GLPB grommet	50
LPL12CKMB	-	Kit: LPL12CPGB with A11BLPB bracket	20
ACCESSORIES			
A11BLPB	A11BLPBP	Black flush mount bracket	50
A11GLPB	A11GLPBP	Gray flush mount bracket	50
A12B2LPB	A12B2LPBP	Black vertical mount bracket	50
A12GLPB	A12GLPBP	Grommet for A12B2LPB	50



LPL12CKM2B



LPL12CKMB

FMVSS	L
MATERIALS	Polycarbonate lens and housing
VOLT/AMP	12.8VDC - 0.030A
WT/DIMS	.022 lb. / 0.74" x 0.74" x .938"
WARRANTY	Lifetime LED Warranty

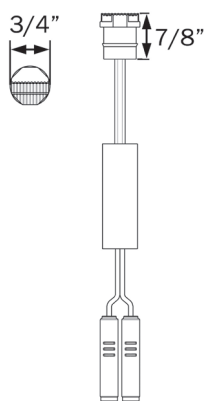

LPL12CB

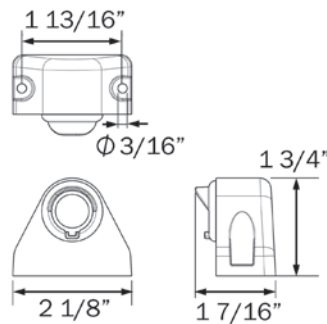

LPL12CKM2B

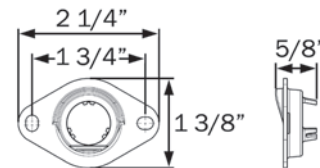

A11GLPB



LPL31 SERIES Mini LED License Light

- Polished, chrome plated housing
- Surface mount on 2" centers
- Design includes both lead and ground wire
- Two LPL31CB/CEZB required to meet DOT requirements, mounted on each side
- Single LPL31CSB required to meet DOT requirements, mounted at center



LPL31CB



LPL31CSB

BULK P/N	POLYPACK P/N	DESCRIPTION	QTY
LICENSE LIGHT - 2 DIODES			
LPL31CB	LPL31CBP	License light	20
LPL31CEZB	LPL31CEZBP	License light, .180 molded barrels	20
LPL31CSB	LPL31CSBP	Light with spacer	50
RETAIL			
LPL31CS		Light with mounting hardware, clam	12

FMVSS	(2) L
MATERIALS	Polycarbonate lens, chrome plated stainless steel bezel
VOLT/AMP	12.8VDC - 0.027A
WT/DIMS	.066 lb. / 2.563" x 1.188" x .938"
WARRANTY	Lifetime LED Warranty

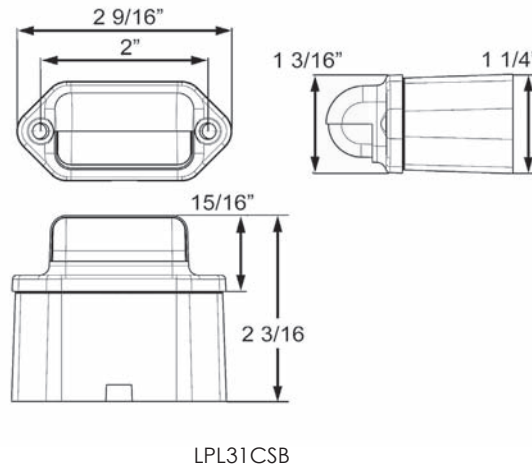
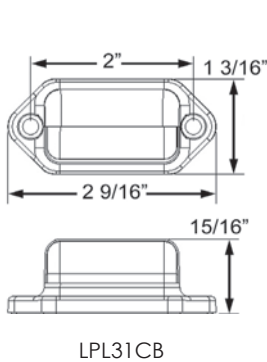

LPL41 SERIES Surface Mount LED License Light



- Armored, chrome plated housing
- Surface mount using ears or studs
- Design includes both lead and ground wire

LPL41CB



BULK P/N	POLYPACK P/N	DESCRIPTION	QTY
LICENSE LIGHT - 5 DIODES			
LPL41CB	LPL41CBP	Ear mount license light	20
LPL42CBF	-	Stud mount license light	20

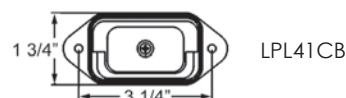

FMVSS	L
MATERIALS	Polycarbonate lens, chrome plated housing, stainless steel mounting ears
VOLT/AMP	12.8VDC - 0.054A
WT/DIMS	.176 lb. / 4" x 1.75" x 2.188"
WARRANTY	Lifetime LED Warranty

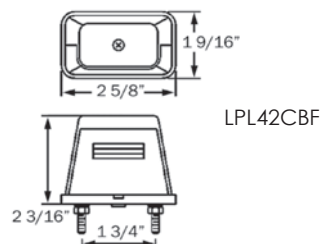

LPL55 SERIES LED License Light with Bracket



- Light attached to corrosion proof black bracket
- Surface mount on 3-1/4" centers
- Design includes both lead and ground wire



LPL55CB

BULK P/N	POLYPACK P/N	DESCRIPTION	QTY
LICENSE LIGHT - 5 DIODES			
LPL55CB	LPL55CBP	Light with ABS bracket	10
LPL55CPG	LPL55CPGP	Light with ABS bracket, female PL-10 plug	10
LPL55CKB	LPL55CKBP	Light/bracket, gasket and hardware	10
LPL56CB	LPL56CBP	Light with steel bracket and gasket	10

FMVSS	L
MATERIALS	Polycarbonate lens and housing, plastic bracket
VOLT/AMP	12.8VDC - 0.045A
WT/DIMS	.198 lb. / 8.625" x 3.25" x 2.375"
WARRANTY	Lifetime LED Warranty

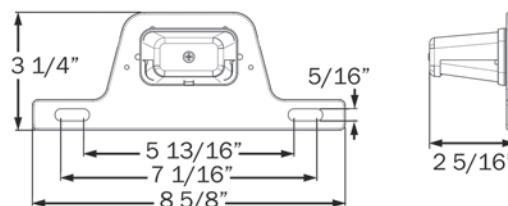



LPL91 SERIES Sealed LED License Light

- Sonically sealed, waterproof
- Use with LP25SB bracket and designated license plate brackets
- Design includes both lead and ground wire



LPL91



LPL26SKB

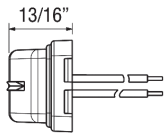
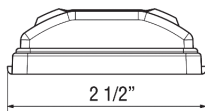
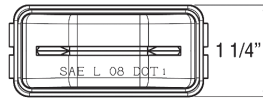

LPL91

BULK P/N	POLYPACK P/N	DESCRIPTION	QTY
LICENSE LIGHT - 2 DIODES			
LPL91CB	LPL91CBP	License light	50
LPL91CAB	LPL91CABP	License light, .156 female plugs	50
LPL91CPG	LPL91CPGP	License light, female PL-10 connector	50
LPL91CKB	LPL91CKBP	License light, A91OB chrome base	50
LPL91CBKB	LPL91CBKBP	License light, A91BOB black base	50
LPL91CKALPB	LPL91CKALPBP	License light, .150 female barrels, black light bracket, gasket	50
LPL26SKB	LPL26SKBP	License light, .180 male bullets, gray light bracket	50

LICENSE PLATE BRACKETS			
LP25SB	LP25SBP	Bracket, black coated	100
LP25SGGB	LP25SGGBP	Bracket, gray coated	
LP5SB	LP5SBP	Straight license plate bracket	100
LP15SB	LP15SBP	Zinc license plate bracket	12
LP35BB	LP35BBP	License plate holder	25

ACCESSORIES			
A91BB	A91BBP	Black base, self grounding	100
A91BOB	A91BOBP	Black base, open back	100
A91CB	A91CBP	Chrome base, self grounding	100
A91OB	A91OBP	Chrome base, open back	100
A91GB	A91GBP	Grommet	100
A82BB	A82BBP	Black base, open back (use with A90CB)	50
A90CB	A90CBP	Chrome cover for A82BB	50

FMVSS	L
MATERIALS	Polycarbonate lens and housing
VOLT/AMP	12.8VDC - 0.027A
WT/DIMS	.066 lb. / 2.5" x 1.25" x 0.813"
WARRANTY	Lifetime LED Warranty

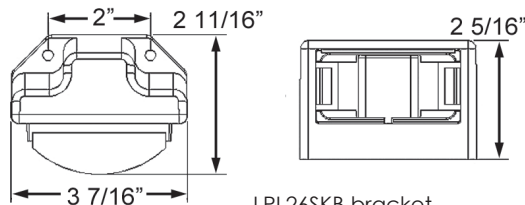

LPL26SKB bracket

BUL13 SERIES 4" Round Sealed LED Utility Light

- Miro-Flex™ design with Crystal Clear™ lens
- Sonically sealed, waterproof
- Accepts standard two-pin plugs

BULK P/N	POLYPACK P/N	DESCRIPTION	QTY
UTILITY LIGHT - 12 DIODES			
BUL13CB	BUL13CBP	Utility light	10
ACCESSORIES			
A45GB	A45GBP	Grommet	50
A45CB	A45CBP	Pigtail, 2-wire	100
A49PB	A49PBP	Right angle pigtail, 2-wire	100

MATERIALS	Polycarbonate lens and housing
VOLT/AMP	12.8VDC - 0.074A
WT/DIMS	.331 lb. / 4.313" x 4.313" x 2.375"
WARRANTY	Lifetime LED Warranty



BUL13CB

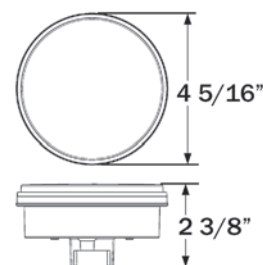

BUL43 SERIES 4" Round Sealed LED Utility Light

- Crystal Clear™ lens
- Sonically sealed, waterproof
- Accepts standard two-pin plugs

BULK P/N	POLYPACK P/N	DESCRIPTION	QTY
UTILITY LIGHT - 10 DIODES			
BUL43CB	BUL43CBP	Utility light	10
ACCESSORIES			
A45GB	A45GBP	Grommet	50
A45CB	A45CBP	Pigtail, 2-wire	100
A49PB	A49PBP	Right angle pigtail, 2-wire	100

MATERIALS	Polycarbonate lens and housing
VOLT/AMP	12.8VDC - 0.275A
WT/DIMS	.529 lb. / 4.313" x 4.313" x 1.938"
WARRANTY	Lifetime LED Warranty



BUL43CB

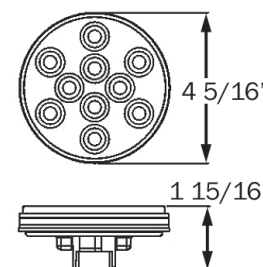



BUL69 SERIES Sealed LED Thinline Utility Light



BUL69CB

- Sonically sealed, waterproof
- Ultra thin – only 5/8" thick
- Design includes both lead and ground wire

BULK P/N	POLYPACK P/N	DESCRIPTION	QTY
UTILITY LIGHT - 11 DIODES			
BUL69CB	BUL69CBP	Utility light	10
BUL69CPG	-	Light with .180 male bullets	10
BUL69CBMCVB	-	Kit: 2-wire female PL-3, A69CB base	10
ACCESSORIES			
A69CB	A69CBP	Chrome base/bezel	10

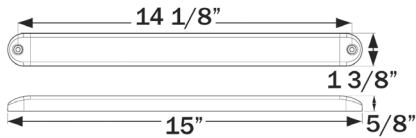

MATERIALS	Polycarbonate lens and housing
VOLT/AMP	12.8VDC - 0.025A
WT/DIMS	.265 lb. / 15" x 1.375" x .625"
WARRANTY	Lifetime LED Warranty



BUL72 SERIES 6" Oval Sealed LED Utility Lights



BUL72CB

- Crystal Clear™ lens
- Sonically sealed, waterproof
- Accepts standard two-pin plugs



BUL74CBTK

BULK P/N	POLYPACK P/N	DESCRIPTION	QTY
UTILITY LIGHT - 10 DIODES			
BUL72CB	BUL72CBP	Utility light	10
BUL72CBGK	BUL72CBGKP	Utility light with A70GB grommet	50
BUL74CBK	BUL74CBKP	Utility light with A70GB & A49PB	50
BUL74CBTK	BUL74CBTKP	Utility light welded to black surface mount bracket, 7.313 mounting centers	30

ACCESSORIES			
A70GB	A70GBP	Grommet	50
A45CB	A45CBP	Pigtail, 2-wire	100
A49PB	A49PBP	Right angle pigtail, 2-wire	100

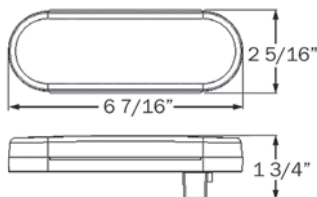

MATERIALS	Polycarbonate lens and housing
VOLT/AMP	12.8VDC - 0.080A
WT/DIMS	Light only: .529 lb. / 6.438" x 2.313" x 1.75" BUL74CBTK: .838 lb. / 8" x 2.563" x 1.813"
WARRANTY	Lifetime LED Warranty

BUL73 SERIES FLEET Count™ 6" Oval Sealed LED Utility Light for Surface Mount

- Sonically sealed, waterproof
- Surface flange mount – no panel cutout required
- Design includes both lead and ground wire

BULK P/N	POLYPACK P/N	DESCRIPTION	QTY
UTILITY LIGHT - 6 DIODES			
BUL73CB	BUL73CBP	Utility light	10
ACCESSORIES			
A78CB	A78CBP	Chrome trim ring	25

MATERIALS	Polycarbonate lens and housing
VOLT/AMP	12.8VDC - 0.054A
WT/DIMS	.265 lb. / 7.563" x 3.313" x .75"
WARRANTY	Lifetime LED Warranty



BUL73CB

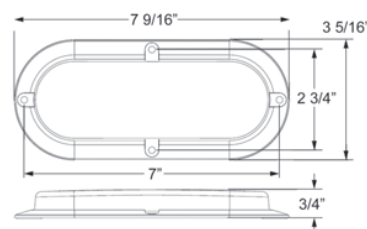

BUL78 SERIES 6" Oval Sealed LED Utility Light for Surface Mount

- Sonically sealed, waterproof
- Surface flange mount – no panel cutout required
- Design includes both lead and ground wire

BULK P/N	POLYPACK P/N	DESCRIPTION	QTY
UTILITY LIGHT - 10 DIODES			
BUL78CB	BUL78CBP	Utility light	10
BUL78CEZB	-	Utility light with 2-way female PL-3	10
BUL78C3MB	BUL78C3MBP	Utility light with 2-way female PL-3 plug, adhesive back	10
ACCESSORIES			
A78CB	A78CBP	Chrome trim ring	25

MATERIALS	Polycarbonate lens and housing
VOLT/AMP	12.8VDC - 0.054A
WT/DIMS	.265 lb. / 7.563" x 3.313" x .75"
WARRANTY	Lifetime LED Warranty



BUL78CB

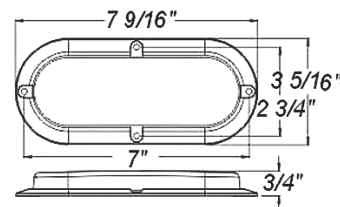



UCL09 SERIES 3" Sealed LED Utility/Hitch Light for Surface Mount



UCL09CB

UCL09CBB

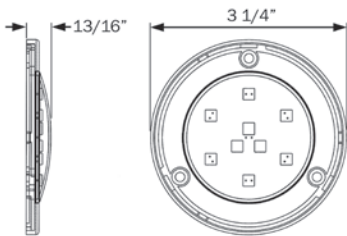

- Designed to illuminate hitch area of trailer
- Sonically sealed, waterproof
- Flange surface mount – no panel cutout required
- Design includes both lead and ground wire

BULK P/N	POLYPACK P/N	DESCRIPTION	QTY
UTILITY LIGHT - 9 DIODES			
UCL09CB	UCL09CBP	Utility light, 9 white LEDs	50
UCL09CBB	UCL09CBBP	Utility light, 6 white, 3 blue LEDs, 3-wire	50
ACCESSORIES			
A09BB	A09BBP	Black snap-on trim ring	50
A09CB	A09CBP	Chrome snap-on trim ring	50
A09WB	A09WBP	White snap-on trim ring	50
A09GB	A09GBP	Gasket for UCL09 series	50
MATERIALS Polycarbonate lens and housing			
VOLT/AMP UCL09CB: 12.8VDC - 0.074A			
UCL09CBB: 12.8VDC - 0.114A			
WT/DIMS .265 lb. / 3.25" x 3.25" x .813"			
WARRANTY Lifetime LED Warranty			



UCL11 SERIES 3/4" Sealed LED Utility Light



UCL11CKB

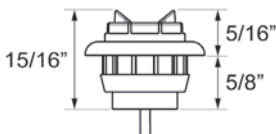
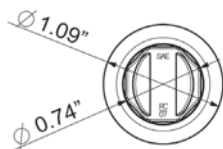

- Sealed, waterproof
- Compact – fits 3/4" hole
- Design includes both lead and ground wire

BULK P/N	POLYPACK P/N	DESCRIPTION	QTY
UTILITY LIGHT - 2 DIODES			
UCL11CB	UCL11CBP	Utility light	50
UCL11CKB	UCL11CKBP	Kit: UCL11CB & A11GB grommet	50
UCL11CKPG	UCL11CKPGP	Kit: UCL11CB with .180 male bullets & A14GB grommet	50
ACCESSORIES			
A11GB	A11GBP	Grommet	100
A14GB	A14GBP	Sealing grommet, .125-.250" material	100
A11PB	A11PBP	Snap-in mounting flange	100
MATERIALS Polycarbonate lens and housing			
VOLT/AMP 12.8VDC - 0.054A			
WT/DIMS .265 lb. / 0.74" x 0.74" x 0.938"			
WARRANTY Lifetime LED Warranty			

UCL13 SERIES Sealed LED Utility Light

- Sealed, waterproof
- Compact, surface mount design
- Design includes both lead and ground wire

BULK P/N	POLYPACK P/N	DESCRIPTION	QTY
WHITE UTILITY LIGHT - 2 DIODES			
UCL13C2PG	UCL13C2PGP	Utility light, .180 female barrels	20
ACCESSORIES			
A13C2B	A13C2BP	Chrome base/bezel	100
A13B2B	A13B2BP	Black base/bezel	100
A13G2B	A13G2BP	Gasket	200
MATERIALS	Polycarbonate lens and housing		
VOLT/AMP	12.8VDC - 0.020A		
WT/DIMS	.088 lb. / 2.5" x 1.063" x .688"		
WARRANTY	Lifetime LED Warranty		



UCL13C2PG

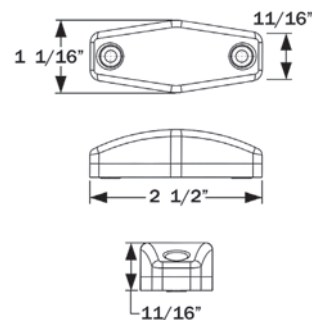

UCL19 SERIES Miro-Flex™ Sealed LED Utility Light

- Sealed, waterproof
- Surface mount, mounts on 4-5/8" centers
- Design includes both lead and ground wire

BULK P/N	POLYPACK P/N	DESCRIPTION	QTY
UTILITY LIGHT - 4 DIODES			
UCL19CB	UCL19CBP	Utility light	20
MATERIALS	Polycarbonate lens and housing		
VOLT/AMP	12.8VDC - 0.051A		
WT/DIMS	.132 lb. / 5.75" x 1.563" x .75"		
WARRANTY	Lifetime LED Warranty		



UCL19CB

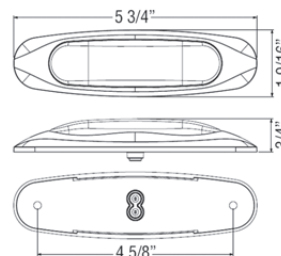



UCL50CB

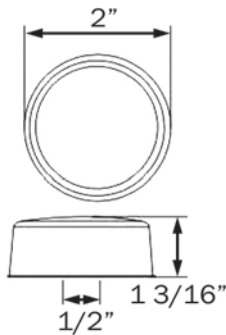

UCL50 SERIES

Miro-Flex™ 2" Sealed LED Utility Light

- Miro-Flex™ design with Crystal Clear™ lens
- Operating voltage 12-24VDC
- Sonically sealed, waterproof
- Accepts standard two-pin PL-10 plug

BULK P/N	POLYPACK P/N	DESCRIPTION	QTY
UTILITY LIGHT - 9 DIODES			
UCL50CB	UCL50CBP	12-24VDC Utility light	20
ACCESSORIES			
A46PB	A46PBP	Straight plug, 6" lead	100
A86PB	A86PBP	Straight plug, 18" lead	100
A54GB	A54GBP	2" Flush mount grommet	100
A54GK	A54GKP	2" Kit: A54GB and A46PB	100
A55CB	A55CBP	2" Chrome trim ring	20
BK5557GB	BK5557GBP	Cam-on mounting bracket	50
MATERIALS	Polycarbonate lens and housing		
VOLT/AMP	12.8VDC - 0.013A		
WT/DIMS	.088 lb. / 2" x 2" x 1.188"		
WARRANTY	Lifetime LED Warranty		



UCL55CB

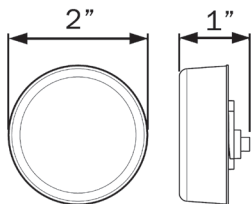

UCL55 SERIES

2" Sealed LED Utility Light

- Sonically sealed, waterproof
- Accepts standard two-pin PL-10 plug

BULK P/N	POLYPACK P/N	DESCRIPTION	QTY
UTILITY LIGHT - 3 DIODES			
UCL55CB	UCL55CBP	Utility light	20
ACCESSORIES			
A46PB	A46PBP	Straight plug, 6" lead	100
A86PB	A86PBP	Straight plug, 18" lead	100
A54GB	A54GBP	2" Flush mount grommet	100
A54GK	A54GKP	2" Kit: A54GB and A46PB	100
A55CB	A55CBP	2" Chrome trim ring	20
BK5557GB	BK5557GBP	Cam-on mounting bracket	50
MATERIALS	Polycarbonate lens and housing		
VOLT/AMP	12.8VDC - 0.047A		
WT/DIMS	.088 lb. / 2" x 2" x 1"		
WARRANTY	Lifetime LED Warranty		

UCL60/160 SERIES Sealed LED Utility Light

- Sealed, waterproof
- Compact, surface mount design
- Design includes both lead and ground wire
- CSA certified for use in sleeping quarters
- Snap-on trim ring included, multiple finishes available

BULK P/N	POLYPACK P/N	DESCRIPTION	QTY
TOUCH SWITCH UTILITY LIGHT - 6 DIODES			
UCL60CSBB	UCL60CSBBP	Utility light, black trim ring	20
UCL60CSNB	-	Utility light, brushed nickel trim ring	20
UTILITY LIGHT, NO SWITCH - 6 DIODES			
UCL60CB	UCL60CBP	Utility light, chrome trim ring	20
UCL60CBSC	-	Utility light, chrome trim ring, connector	20
UCL60CSCB	-	Utility light, chrome trim ring, Delphi connector	20

Raw lumen output: 224 lm
Effective lumen output: 168 lm

BULK P/N	POLYPACK P/N	DESCRIPTION	QTY
GLOLIGHT™ UTILITY LIGHT - 6 DIODES			
UCL160CB	UCL160CBP	Utility light, chrome trim ring	20

Raw lumen output: 224 lm
Effective lumen output: 168 lm

MATERIALS	Polycarbonate lens and housing
VOLT/AMP	12.8VDC - 0.020A
WT/DIMS	.088 lb. / 3" x 3" x .375"
WARRANTY	Lifetime LED Warranty

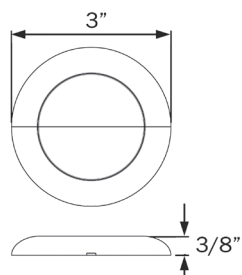



UCL65 SERIES Sealed LED Thinline Utility Light



UCL65CB

- Sealed, waterproof
- Multiple mounting and wiring options available

BULK P/N	POLYPACK P/N	DESCRIPTION	QTY
UTILITY LIGHT - 6 DIODES			
UCL65CB	UCL65CBP	Utility light	20
ACCESSORIES			
A65B	A65BP	Black bracket	50
A65P	A65PP	Single wire plug, .156 male bullet	50
A65PB	A65PBP	Kit: A65B black bracket & A65P plug	50
A66PB	A66PBP	Kit: Gray bracket & A65P plug	50
A67CB	A67CBP	Kit: Chrome bracket & A65P plug	50
A68PB	A68PBP	Kit: Black bracket & 2-wire plug	50

For more details on mounting and wiring accessories, see Accessories section at back of catalog.

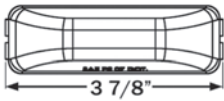

MATERIALS	Polycarbonate lens and housing
VOLT/AMP	12.8VDC - 0.048A
WT/DIMS	.066 lb. / 3.875" x 1.25" x 1.125"
WARRANTY	Lifetime LED Warranty

ILLO1 SERIES 3/4" LED Emergency Egress Light

- 3/4" recess mount light for use in transit vehicles
- Hard wired, includes lead and ground with female Staykon connectors
- Sealed, waterproof construction – maintenance free
- Snap-in design for quick and easy installation

BULK P/N	BOX/UPC P/N	DESCRIPTION	QTY
EGRESS LIGHT - 1 DIODE			
ILL01RB	ILL01RBP	3/4" egress light	50

MATERIALS	Polycarbonate lens and housing
VOLT/AMP	12.8VDC - .1A
WT/DIMS	0.018 lb. / .695" x .695" x .81"
WARRANTY	Lifetime LED Warranty

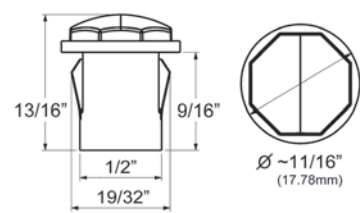

ILLO6 SERIES Opti-Brite™ LED Mini Dome Light

- Compact 11-inch dome light fits many applications
- Design includes 6-inch, 16-gauge power and ground wires with tinned ends

BULK P/N	BOX/UPC P/N	DESCRIPTION	QTY
DOME LIGHT - 16 DIODES			
ILL06COB	ILL06COBP	Mini dome light	12 / 6

Effective lumen output: 390 lm

MATERIALS	Polycarbonate lens and housing
VOLT/AMP	12.8VDC - .48A
WT/DIMS	0.5 lb. / 11" x 4" x .94"
WARRANTY	Three Year Warranty



ILL06COB

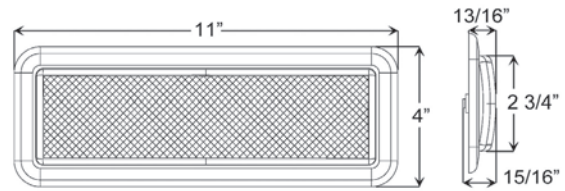



ILL08COB



ILL28CMB

ILLO8 SERIES Opti-Brite™ LED Dome Lights

- Designed for use in extreme temperatures; ideal for refrigerated trucks and trailers (-40 to 140 degrees F)
- Operating voltage 7-30VDC; voltage cut-off at 7VDC prevents battery drain
- Use with both 12VDC and 24VDC systems; light output remains consistent at all operating voltages (no dimming), cutting off when voltage is outside range
- Design includes 16-inch, 16-gauge power and ground wires with tinned ends

BULK P/N	BOX/UPC P/N	DESCRIPTION	QTY
DOMELIGHT - 8 DIODES			
ILL08COB	ILL08COBP	Light	6
ILL08COPG		Light, .180 male bullets	6
MOTION SENSOR DOMELIGHT - 8 DIODES			
ILL28CMB	ILL28CMBP	Light with motion sensor	6
ILL28CMPG	-	Light with motion sensor, .180 male bullets	6

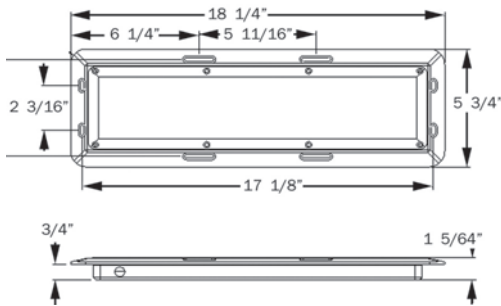

ILL08/28/10 SERIES DIMENSIONS

Raw lumen output: 1400 lm
Effective lumen output: 990 lm

MATERIALS	Polycarbonate lens and housing
VOLT/AMP	12.8VDC - 1.61A; 24VDC - 0.80A
WT/DIMS	1 lb. / 18.25" x 5.75" x 1.078"
WARRANTY	Three Year Warranty

ILL10 SERIES Opti-Brite™ LED Dome Light

For 12VDC systems, general applications



ILL10CCB

BULK P/N	BOX/UPC P/N	DESCRIPTION	QTY
DOMELIGHT - 10 DIODES			
ILL10CCB	ILL10CCBP	11-16VDC Dome light	6

Raw lumen output: 1100 lm
Effective lumen output: 880 lm

MATERIALS	Polycarbonate lens and housing
VOLT/AMP	12.8VDC - 1.8A
WT/DIMS	1 lb. / 18.25" x 5.75" x 1.078"
WARRANTY	Three Year Warranty

ILL21 SERIES

Opti-Brite™ LED 6" Dome Light

- Low profile dome light – less than 5/8" thick
- Operating voltage 12-24VDC; use with both 12VDC and 24VDC systems
- Low voltage cut-off at 11VDC, prevents battery drain
- Sealed, waterproof

BULK P/N	POLYPACK P/N	DESCRIPTION	QTY
DOMELIGHT - 21 DIODES			
ILL21CB	ILL21CBP	Dome light, two-wire, .180 male bullets	10
ILL21CTPB	-	ILL21CB with adhesive mounting pad	10
A21CHB	-	Chrome trim ring	25
A21WB	-	White trim ring	25

Raw lumen output: 250 lm
Effective lumen output: 214 lm

MATERIALS	Polycarbonate lens and housing
VOLT/AMP	12.8VDC - .408A; 24VDC - .385A
WT/DIMS	.250 lb. / 6.0938" x 6.0938" x .625"
WARRANTY	Lifetime LED Warranty



ILL21CB

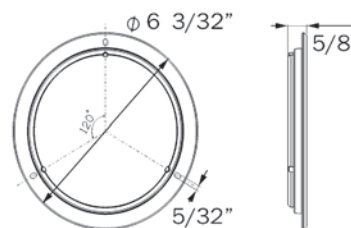

ILL39 SERIES

Opti-Brite™ LED 7" Dome Light

- Low profile dome light – less than 5/8" thick
- Operating voltage 12-24VDC; use with both 12VDC and 24VDC systems
- Low voltage cut-off at 11VDC, prevents battery drain
- Hard wired design includes 16-gauge power and ground wires with .180 male bullets
- Sealed, waterproof

BULK P/N	POLYPACK P/N	DESCRIPTION	QTY
DOMELIGHT - 39 DIODES			
ILL39CB	ILL39CBP	Dome light	5/10

Raw lumen output: 460 lm
Effective lumen output: 390 lm

MATERIALS	Polycarbonate lens and housing
VOLT/AMP	12.8VDC - .669A; 24VDC - .217A
WT/DIMS	.350 lb. / 6.969" x 6.969" x .625"
WARRANTY	Lifetime LED Warranty



ILL39CB

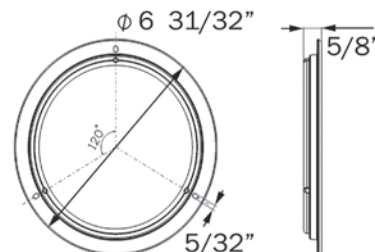



ILL22 SERIES Sealed LED Dome Lights



ILL22CB

- Low profile dome lights – less than 1" thick
- Sealed, waterproof design
- Hard wired with 6" power and ground wires

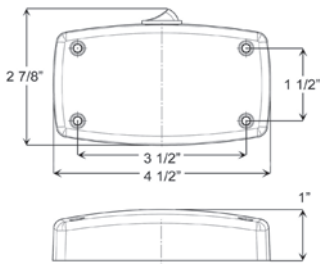

BULK P/N	POLYPACK P/N	DESCRIPTION	QTY
DOMELIGHT - 18 DIODES			
ILL22CB	ILL22CBP	Dome light, on/off switch	10
ILL22CHB	ILL22CHBP	Dome light, no switch	10

Raw lumen output: 1044 lm
Effective lumen output: 810 lm

MATERIALS	Polycarbonate lens and housing
VOLT/AMP	12.8VDC - .7A
WT/DIMS	.182 lb. / 4.5" x 2.875" x 1"
WARRANTY	Three Year Warranty



ILL24/124 SERIES Sealed LED 6" Dome Lights



ILL124CB

- Low profile dome lights – only 7/8" thick
- Sealed, waterproof
- Hard wired design includes power and ground wires

BULK P/N	POLYPACK P/N	DESCRIPTION	QTY
GLOLIGHT™ DOMELIGHT - 24 DIODES			
ILL124CB	ILL24CBP	Dome light, GloLight™ lens	10
DOMELIGHT - 24 DIODES			
ILL24CB	ILL24CBP	Dome light	10

Raw lumen output: 585 lm
Effective lumen output: 453 lm



ILL24CB

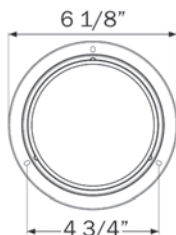

MATERIALS	Polycarbonate lens and housing
VOLT/AMP	12.8VDC - .127A
WT/DIMS	.353 lb. / 6.125" x 6.125" x 0.875"
WARRANTY	Lifetime LED Warranty

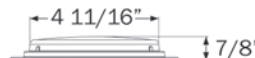

ILL30CBB SERIES Constellation™ LED Bullet Light

- Surface mount fixture; trim ring covers mounting hardware
- Ratchet motion design with on/off switch
- Lightly frosted lens
- Hard wired design includes power and ground wires

BULK P/N	POLYPACK P/N	DESCRIPTION	QTY
BULLET LIGHT - 1 DIODE			
ILL30CBB	ILL30CBBP	Bullet light	25

MATERIALS	Plastic housing
VOLT/AMP	12.8VDC - .288A
WT/DIMS	.250 lb. / 3.75" x 1.938" x 3.5"
WARRANTY	Lifetime LED Warranty



ILL30CBB

ILL31/32/35 SERIES LED Low Profile Dome Lights

- Low profile dome lights for semi-recess or surface mount
- Durable steel housing and replaceable polycarbonate lens
- Hard wired design includes power and ground wires
- Select from standard diode or SMD LED models

BULK P/N	POLYPACK P/N	DESCRIPTION	QTY
RECESS MOUNT DOME LIGHT - 10 DIODES			
ILL31CB	ILL31CBP	Standard LED	10
ILL35CB	-	SMD LED	10
SURFACE MOUNT DOME LIGHT - 10 DIODES			
ILL32CB	ILL32CBP	SMD LED	10
ILL32CPG	-	SMD LED, .180 male bullets	10

Raw lumen output:	70 lm
Effective lumen output:	53 lm

MATERIALS	Polycarbonate lens, plated steel housing
VOLT/AMP	12.8VDC - .024A
WT/DIMS	ILL31/35: .243 lb. / 5.75" x 2.75" x .938" ILL32: .243 lb. / 5.75" x 2.75" x .75"
WARRANTY	Lifetime LED Warranty



ILL31CB

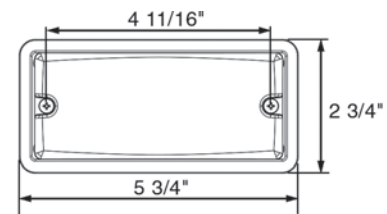

ILL31/32/35



ILL31/35 - recess mount



ILL32 - surface mount



ILL33CB

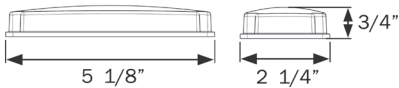
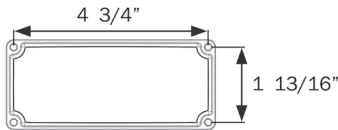

ILL33 SERIES

Opti-Brite™ LED Sealed Dome Light

- Low profile surface mount design – less than 3/4" thick
- Hard wired design includes 18-gauge lead wires
- Sealed, waterproof

BULK P/N	POLYPACK P/N	DESCRIPTION	QTY
DOME LIGHT - 10 DIODES			
ILL33CB	ILL33CBP	Dome light	10

Raw lumen output: 210 lm
Effective lumen output: 160 lm

MATERIALS	Polycarbonate lens and housing
VOLT/AMP	12.8VDC - .147A
WT/DIMS	.154 lb. / 5.125" x 2.25" x .75"
WARRANTY	Lifetime LED Warranty

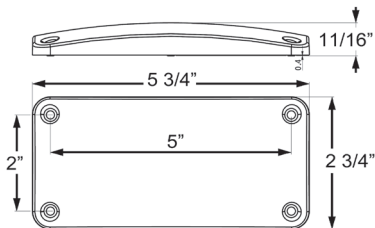

ILL36 SERIES

Opti-Brite™ LED Sealed Dome Light

- Low profile surface mount design – less than 3/4" thick
- Sealed, waterproof
- Durable polycarbonate construction

BULK P/N	POLYPACK P/N	DESCRIPTION	QTY
DOME LIGHT - 9 DIODES			
ILL36CB	ILL36CBP	Dome light	10

Raw lumen output: 400 lm
Effective lumen output: 227 lm

MATERIALS	Polycarbonate lens and housing
VOLT/AMP	12.8VDC - .33A
WT/DIMS	.154 lb. / 5.75" x 2.75" x .688"
WARRANTY	Lifetime LED Warranty

ILL70/71/72 SERIES

Opti-Brite™ LED Interior Strip Lights for Surface Mount



- Low profile, slimline lights – only 1" wide by 5/8" thick
- Hard wired design includes both lead and ground wires
- Select from 9-inch, 16-inch and 22-inch models
- Sealed, waterproof



ILL70CB



ILL71CB



ILL72CB

BULK P/N	POLYPACK P/N	DESCRIPTION	QTY
9" STRIP LIGHT - 9 DIODES			
ILL70CB	ILL70CBP	Strip light	20/10
ILL70CSB	-	Strip light with on/off switch	10
<p>Raw lumen output: 189 lm Effective lumen output: 171 lm</p>			
16" STRIP LIGHT - 18 DIODES			
ILL71CB	ILL71CBP	Strip light	20/10
ILL71CSB	-	Strip light with on/off switch	10
<p>Raw lumen output: 370 lm Effective lumen output: 342 lm</p>			
22" STRIP LIGHT - 27 DIODES			
ILL72CB	ILL72CBP	Strip light	20/10
<p>Raw lumen output: 567 lm Effective lumen output: 513 lm</p>			

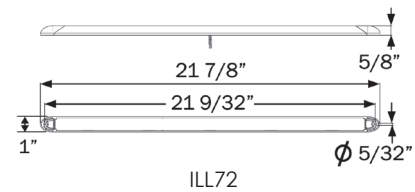
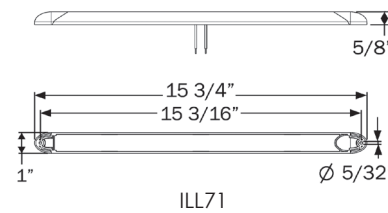
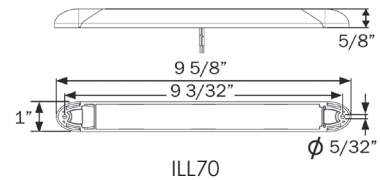

MATERIALS	Polycarbonate lens and housing
VOLT/AMP	ILL70: 12.8VDC - .150A ILL71: 12.8VDC - .300A ILL72: 12.8VDC - .480A
WT/DIMS	ILL70: .154 lb. / 9.625" x 1" x .625" ILL71: .187 lb. / 15.75" x 1" x .625" ILL72: .210 lb. / 21.875" x 1" x .625"
WARRANTY	Lifetime LED Warranty



ILL70/71 SERIES Opti-Brite™ LED Awning Lights for Surface Mount



ILL70CBAWN



ILL71CBAWN

- Low profile awning mount lights with wedge base that directs light at a 45-degree angle
- Hard wired design includes both lead and ground wires
- Select from 11-inch and 18-inch models
- Available in amber and white LED
- Sealed, waterproof

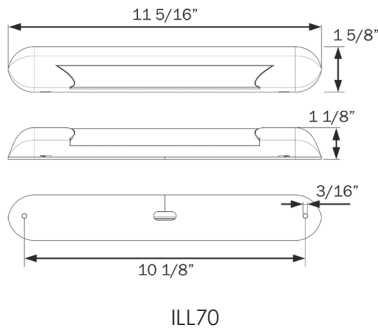

BULK P/N	POLYPACK P/N	DESCRIPTION	QTY
11" WHITE LED - 9 DIODES			
ILL70CBAWN	-	No switch, white end caps	10
ILL70CBBAWN	-	No switch, black end caps	10
ILL70CBSBAWN	-	On/off switch, black end caps	10
ILL70CCSBAWN	-	On/off switch, chrome end caps	10
11" AMBER LED - 9 DIODES			
ILL70ABAWN	-	No switch, white end caps	10
ILL70ABBAWN	-	No switch, black end caps	10
Raw lumen output: 189 lm Effective lumen output: 171 lm			

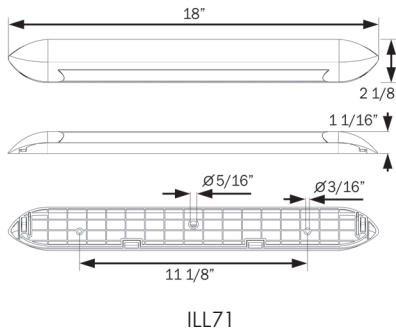

BULK P/N	POLYPACK P/N	DESCRIPTION	QTY
18" WHITE LED - 18 DIODES			
ILL71CBAWN	-	No switch, white end caps	10
ILL71CBBAWN	-	No switch, black end caps	10
18" AMBER LED - 18 DIODES			
ILL71ABAWN	-	No switch, white end caps	10
ILL71ABBAWN	-	No switch, black end caps	10
Raw lumen output: 370 lm Effective lumen output: 342 lm			

IP67 rating: protected from dust and capable of withstanding water immersion, offering increased reliability and service life

MATERIALS	Polycarbonate lens and housing		
VOLT/AMP	ILL70:	12.8VDC - .150A	
	ILL71:	12.8VDC - .300A	
WT/DIMS	ILL70:	.154 lb. / 11.313" x 1.625" x 1.125"	
	ILL71:	.187 lb. / 18" x 2.125" x 1.063"	
WARRANTY	Lifetime LED Warranty		

ILL85 SERIES LED Exterior Step/Area Light

- Illuminate step well or pavement at base of steps or ramps
- Meets ADA lighting standard
- Surface mount, 3.662" mounting centers
- Hard wired design includes both lead and ground wires
- Operating voltage 8-30VDC, for use with 12VDC or 24VDC systems
- Polycarbonate construction with polished chrome finish
- Mounting gasket included



ILL85CB

BULK P/N	POLYPACK P/N	DESCRIPTION	QTY
STEP/AREA LIGHT - 10 DIODES			
ILL85CB	ILL85CBP	Step/area light	10

MATERIALS	Polycarbonate lens and housing
VOLT/AMP	12.8VDC - .107A
WT/DIMS	.154 lb. / 4.25" x 1.24" x 1.69"
WARRANTY	Lifetime LED Warranty

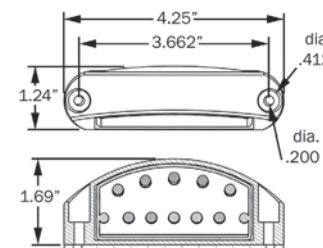

ILL86 SERIES LED Exterior Step/Area Light

- Illuminate step well or pavement at base of steps or ramps
- Meets ADA lighting standard
- Surface mount, 2.92" mounting centers
- Hard wired design includes both lead and ground wires
- Die cast aluminum housing coated for protection against corrosion and UV exposure; polycarbonate lens



ILL86CB

BULK P/N	POLYPACK P/N	DESCRIPTION	QTY
STEP/AREA LIGHT - 5 DIODES			
ILL86CB	ILL86CBP	Step/area light, white finish	10

MATERIALS	Die cast aluminum housing, polycarbonate lens
VOLT/AMP	12.8VDC - .25A
WT/DIMS	.154 lb. / 4" x 2.5" x 1.313"
WARRANTY	Lifetime LED Warranty

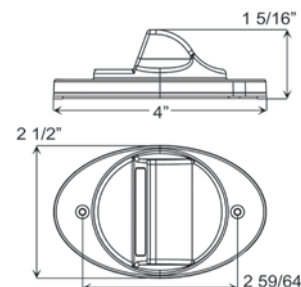



ILL91 SERIES 6" LED Interior Dome Light



ILL91CB

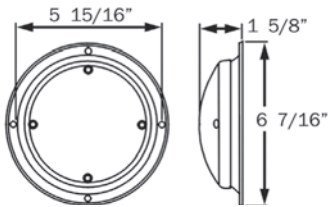

- Surface mount steel base, chrome plated
- Hard wired design includes both lead and ground wires
- Two diodes provide low amp draw, bright white light

BULK P/N	POLYPACK P/N	DESCRIPTION	QTY
DOMELIGHT - 6 DIODES			
ILL91CB	ILL91CBP	Dome light	10

Raw lumen output: 600 lm
Effective lumen output: 540 lm

MATERIALS	Polycarbonate lens and housing
VOLT/AMP	12.8VDC - .35A
WT/DIMS	.154 lb. / 6.438" x 6.438" x 1.625"
WARRANTY	Lifetime LED Warranty



LM SERIES LED Utility, Courtesy & Accent Lights



LM112CB



LM315BB



LM835CB

- LM112CB is recess mount waterproof light for use above or below water level. Single diode. Plastic housing.
- LM315BB is semi-recess mount courtesy light
- LM835CB is eight-diode recess mount accent light with clear lens and chrome trim ring; screw mount
- All models are hard wired with ground wire

BULK P/N	POLYPACK P/N	DESCRIPTION	QTY
WATERPROOF UTILITY LIGHT - 1 DIODE			
LM112CB	LM112CBP	Waterproof mini utility light	50

COURTESY LIGHT - 3 DIODES			
LM315BB	LM315BBP	Courtesy light, black	50

ACCENT LIGHT - 8 DIODE			
LM835CB	LM835CBP	Recess mount accent light	50

MATERIALS	Polycarbonate lens and housing		
VOLT/AMP	LM112CB:	12.8VDC - .013A	
	LM315BB:	12.8VDC - .007A	
	LM835CB:	12.8VDC - .087A	
WT/DIMS	LM112CB:	.154 lb. / 1.25" x 1.25" x 1.25"	
	LM315BB:	.187 lb. / 2.25" x 2.25" x 1.625"	
	LM835CB:	.210 lb. / 3.75" x 3.75" x 0.75"	
WARRANTY	Lifetime LED Warranty		

TLL44/45 SERIES Opti-Brite™ LED Work Lights

- Heavy duty design with powder coated, die cast aluminum housing and polycarbonate lens
- Low profile design – only 2 inches deep
- Dual power: use with 12VDC and 24VDC systems
- Stainless steel mounting hardware
- 14-gauge, 10” lead and ground wire



TLL44FB

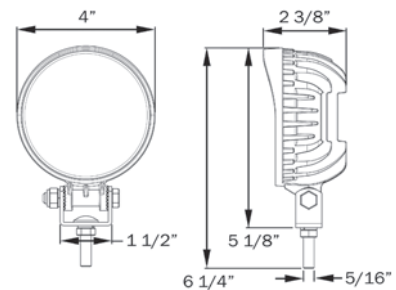

BULK P/N	POLYPACK P/N	DESCRIPTION	QTY
ROUND LED WORK LIGHT - 6 DIODES			
TLL44FB	TLL44FBP	Flood beam	2
RETAIL			
TLL44FS		Flood beam, window box	1
Raw lumen output: 1200 lm Effective lumen output: 720 lm			
MATERIALS	Polycarbonate lens, aluminum housing		
VOLT/AMP	12.8VDC - 1.1A, 24.0VDC - 0.48A		
WT/DIMS	0.98 lbs. / 4" x 6.281" x 2.375"		
WARRANTY	Three Year Warranty		

BULK P/N	POLYPACK P/N	DESCRIPTION	QTY
ROUND LED WORK LIGHT - 8 DIODES			
TLL45FB	TLL45FBP	Flood beam	3
Raw lumen output: 1600 lm Effective lumen output: 897 lm			
MATERIALS	Polycarbonate lens, aluminum housing		
VOLT/AMP	12.8VDC - 1.38A, 24.0VDC - 0.65A		
WT/DIMS	1.389 lbs. / 4.5" x 7" x 2"		
WARRANTY	Three Year Warranty		



TLL45FB

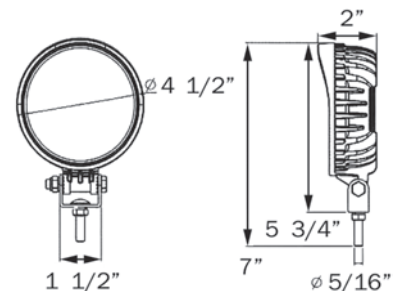

TLL44FS

IPX9K RATING
Highest designation available for water ingress testing, offering increased reliability and service life when subjected to severe environmental conditions or cleaning methods.



TLL46 SERIES Opti-Brite™ LED Work Lights

- Heavy duty design with powder coated, die cast aluminum housing and polycarbonate lens
- Low profile design – less than 2.5 inches deep
- Dual power: use with 12VDC and 24VDC systems
- Stainless steel mounting hardware
- 14-gauge, 10" lead and ground wire



TLL46CFB



BULK P/N	POLYPACK P/N	DESCRIPTION	QTY
FLOOD BEAM - 9 DIODES			
TLL46CFB	TLL46CFBP	Flood beam	3
Raw lumen output: 1800 lm			
Effective lumen output: 1042 lm			

MATERIALS	Polycarbonate lens, aluminum housing
VOLT/AMP	12.8VDC - 1.70A, 24.0VDC - 1.0A
WT/DIMS	1.764 lbs. / 5" x 7" x 2.375"
WARRANTY	Three Year Warranty



TLL46TB



BULK P/N	POLYPACK P/N	DESCRIPTION	QTY
TRAPEZOID BEAM - 9 DIODES			
TLL46TB	TLL46TBP	Trapezoid beam	3
Raw lumen output: 1800 lm			
Effective lumen output: 707 lm			

MATERIALS	Polycarbonate lens, aluminum housing
VOLT/AMP	12.8VDC - 1.50A, 24.0VDC - 0.73A
WT/DIMS	1.764 lbs. / 5" x 7" x 2.375"
WARRANTY	Three Year Warranty

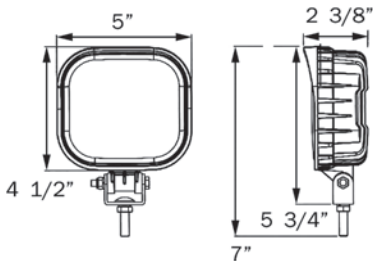

IPX9K RATING

Highest designation available for water ingress testing, offering increased reliability and service life when subjected to severe environmental conditions or cleaning methods.

TLL48 SERIES Opti-Brite™ LED Work Light

- Heavy duty design with powder coated, die cast aluminum housing and polycarbonate lens
- Low profile design – less than 2.5 inches deep
- Dual power: use with 12VDC and 24VDC systems
- Stainless steel mounting hardware
- 14-gauge, 10" lead and ground wire; **IPX9K** rating

BULK P/N	POLYPACK P/N	DESCRIPTION	QTY
FLOOD BEAM - 6 DIODES			
TLL48FB	TLL48FBP	Flood beam	5
Raw lumen output: 1200 lm Effective lumen output: 617 lm			
MATERIALS	Polycarbonate lens, aluminum housing		
VOLT/AMP	12.8VDC - 1.52A, 24.0VDC - 0.65A		
WT/DIMS	1.14 lbs. / 4.15" x 6.375" x 2.14"		
WARRANTY	Three Year Warranty		



TLL48FB

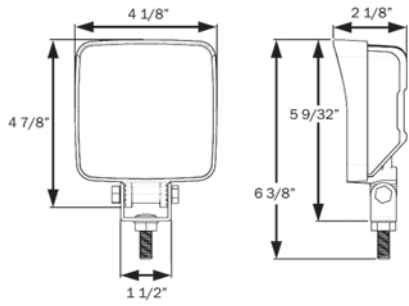

TLL50 SERIES Opti-Brite™ LED Work Light

- Lightweight, compact LED work light
- Corrosion proof housing and polycarbonate lens
- Dual power: use with 12VDC and 24VDC systems
- 22-gauge, 10" lead and ground wire
- **IPX9K** rating

BULK P/N	POLYPACK P/N	DESCRIPTION	QTY
FLOOD BEAM - 9 DIODES			
TLL50FB	TLL50FBP	Flood beam	3
RETAIL			
TLL50FS		Flood beam, window box	1
Raw lumen output: 324 lm Effective lumen output: 252 lm			



TLL50FB



TLL50FS

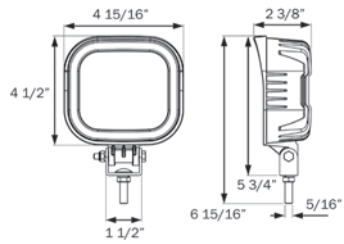

MATERIALS	Polycarbonate lens and housing, stainless steel hardware
VOLT/AMP	12.8VDC - 1.50A, 24.0VDC - 0.73A
WT/DIMS	1 lbs. / 4.938" x 6.938" x 2.375"
WARRANTY	Three Year Warranty



TLL51 SERIES Opti-Brite™ LED Work Light



TLL51FB

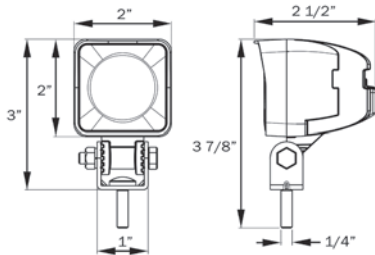

- Heavy duty design with powder coated, die cast aluminum housing and polycarbonate lens
- Compact design – only 2 inches square
- Dual power: use with 12VDC and 24VDC systems
- Stainless steel mounting hardware
- 14-gauge, 10" lead and ground wire; **IPX9K** rating

BULK P/N	POLYPACK P/N	DESCRIPTION	QTY
FLOOD BEAM - 1 DIODE			
TLL51FB	TLL51FBP	Flood beam	10

Raw lumen output: 800 lm
Effective lumen output: 549 lm

MATERIALS	Polycarbonate lens, aluminum housing
VOLT/AMP	12.8VDC - 0.91A, 24.0VDC - 0.42A
WT/DIMS	0.37 lbs. / 2" x 3" x 2.5"
WARRANTY	Three Year Warranty



TLL52 SERIES Opti-Brite™ LED Work Light



TLL52FWB

TLL52FB

- Heavy duty design with powder coated, die cast aluminum housing and polycarbonate lens
- Compact design – only 2.75 inches square
- Dual power: use with 12VDC and 24VDC systems
- Stainless steel mounting hardware
- 14-gauge, 10" lead and ground wire; **IPX9K** rating

BULK P/N	POLYPACK P/N	DESCRIPTION	QTY
FLOOD BEAM - 3 DIODES			
TLL52FB	TLL52FBP	Flood beam, black housing	10
TLL52FWB	TLL52FWBP	Flood beam, white housing	10

RETAIL

TLL52FS		Flood beam, window box	1
---------	--	------------------------	---

Raw lumen output: 600 lm
Effective lumen output: 325 lm



TLL52FS

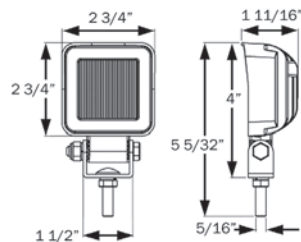

MATERIALS	Polycarbonate lens and housing, stainless steel hardware
VOLT/AMP	12.8VDC - 1.50A, 24.0VDC - 0.73A
WT/DIMS	.38 lbs. / 2.75" x 5.171" x 1.687"
WARRANTY	Three Year Warranty

TLL54 SERIES Opti-Brite™ LED Work Light

- Heavy duty design with powder coated, die cast aluminum housing and polycarbonate lens
- Low profile design – less than 2.5 inches deep
- Dual power: use with 12VDC and 24VDC systems
- Stainless steel mounting hardware
- 14-gauge, 10" lead and ground wire; **IPX9K** rating

BULK P/N	POLYPACK P/N	DESCRIPTION	QTY
SPOT BEAM - 9 DIODES			
TLL54TB	TLL54TBP	Spot beam	5

Raw lumen output: 1800 lm
Effective lumen output: 900 lm

MATERIALS	Polycarbonate lens, aluminum housing
VOLT/AMP	12.8VDC - 1.50A, 24.0VDC - 0.73A
WT/DIMS	1.51 lbs. / 5" x 7" x 2.375"
WARRANTY	Three Year Warranty



TLL54TB

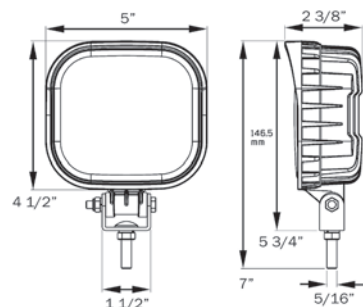

TLL56/57 SERIES Opti-Brite™ LED Work Lights

- Heavy duty design with powder coated, die cast aluminum housing and polycarbonate lens
- Effective lumen output **4000 lumens**
- Dual power: use with 12VDC and 24VDC systems
- Stainless steel mounting hardware
- 16-gauge, 20" lead and ground wire; **IPX9K** rating

BULK P/N	POLYPACK P/N	DESCRIPTION	QTY
FLOOD BEAM - 8 DIODES			
TLL56FB	TLL56FBP	Flood beam	2
TLL57FB	TLL57FBP	Flood beam, shock mount	2

Raw lumen output: 5600 lm
Effective lumen output: 4000 lm

MATERIALS	Polycarbonate lens, aluminum housing
VOLT/AMP	12.8VDC - 5.0A, 24.0VDC - 2.5A
WT/DIMS	3.53 lbs. / 7.161" x 9" x 4.313"
WARRANTY	Three Year Warranty



TLL56FB

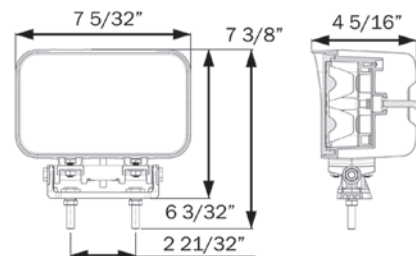



TLL60FB

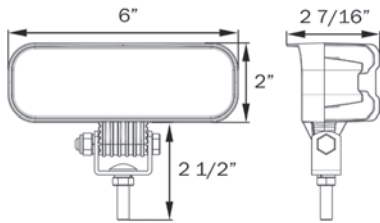

TLL60 SERIES Opti-Brite™ LED Work Light

- Heavy duty design with powder coated, die cast aluminum housing and polycarbonate lens
- Rectangular design – 6 inches wide by 2 inches high
- Dual power: use with 12VDC and 24VDC systems
- Stainless steel mounting hardware
- 14-gauge, 10" lead and ground wire; **IPX9K** rating

BULK P/N	POLYPACK P/N	DESCRIPTION	QTY
FLOOD BEAM - 6 DIODES			

TLL60FB	TLL60FBP	Flood beam	5
---------	----------	------------	---

Raw lumen output: 1200 lm
Effective lumen output: 720 lm

MATERIALS	Polycarbonate lens, aluminum housing
VOLT/AMP	12.8VDC - 1.1A, 24.0VDC - 0.48A
WT/DIMS	0.95 lbs. / 6" x 4.5" x 2.4"
WARRANTY	Three Year Warranty



TLL64FB

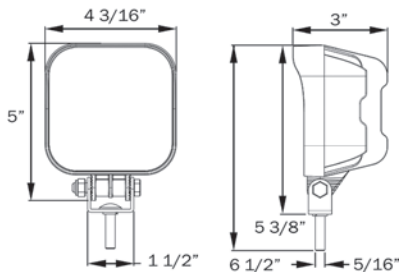

TLL64 SERIES Opti-Brite™ LED Work Light

- Heavy duty design with powder coated, die cast aluminum housing and polycarbonate lens
- Ultrabright output in standard size light – 1939 lumens
- Dual power: use with 12VDC and 24VDC systems
- Stainless steel mounting hardware
- 14-gauge, 10" lead and ground wire; **IPX9K** rating

BULK P/N	POLYPACK P/N	DESCRIPTION	QTY
FLOOD BEAM - 4 DIODES			

TLL64FB	TLL64FBP	Flood beam	2
---------	----------	------------	---

Raw lumen output: 3200 lm
Effective lumen output: 1939 lm

MATERIALS	Polycarbonate lens, aluminum housing
VOLT/AMP	12.8VDC - 3.16A, 24.0VDC - 1.41A
WT/DIMS	1.41 lbs. / 4.187" x 6.5" x 3"
WARRANTY	Three Year Warranty

TLL80 SERIES Opti-Brite™ LED Mini Flood Light

- Coated die cast aluminum housing, polycarbonate lens
- Compact design – only 3 inches wide by 2 inches high
- Bright white SMD diodes for bright, dependable light



TLL80FB

BULK P/N	POLYPACK P/N	DESCRIPTION	QTY
FLOOD BEAM - 6 DIODES			
TLL80FB	TLL80FBP	Flood beam, black housing	5
TLL80FWB	TLL80FWBP	Flood beam, white housing	5

Raw lumen output: 270 lm
Effective lumen output: 150 lm

MATERIALS	Polycarbonate lens, aluminum housing		
VOLT/AMP	12.8VDC - .19A		
WT/DIMS	.7 lbs. / 3" x 2" x 1.563"		
WARRANTY	Three Year Warranty		

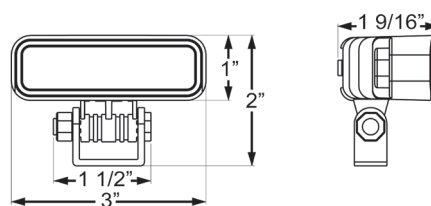

DLL25/50 SERIES LED Docking/Utility Lights

- Wide, low beam ideal for docking or loading applications
- Die cast aluminum housing coated for protection against corrosion and UV exposure; durable polycarbonate lens
- Sealed lens, gasket at wire entry; IP44 rating
- Dual power: use with 12VDC and 24VDC systems
- Stainless steel mounting hardware
- 20-gauge lead and ground wire with tinned ends



DLL50CB

DLL25WC

BULK P/N	POLYPACK P/N	DESCRIPTION	QTY
DOCKING/UTILITY LIGHTS - 2 DIODES			
DLL50CB	DLL50CBP	Black housing	10
RETAIL			
TLL25FS		Black housing, clam	3
DLL25WC		White housing, clam	3
DLL50CC		Pair of lights, black housing, box	3
DLL50WC		Pair of lights, white housing, box	3

MATERIALS	Polycarbonate lens, aluminum housing		
VOLT/AMP	12.8/24.0VDC - 0.683A		
WT/DIMS	DLL50CB:	1.23 lbs. / 5" x 4" x 3.5"	
	DLL50CC/WC:	3.00 lbs. / 5" x 4" x 3.5"	
WARRANTY	Three Year Warranty		

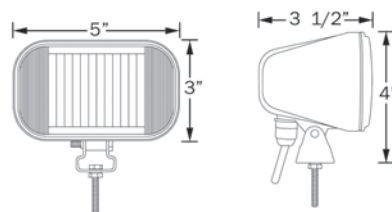

Raw lumen output: 440 lm
Effective lumen output: 396 lm



ST45 SERIES 4" Round Sealed Lights

- Sonically sealed, waterproof
- Shock-proof socket guarantees long bulb life
- Accepts standard PL-3 plug
- Kits include grommet and plug



ST45RB



ST45AB



ST46RB



ST47RB



ST45RGB male pin connection detail

BULK P/N	POLYPACK P/N	DESCRIPTION	QTY
RED STOP/TURN/TAIL LIGHTS			
ST45RB	ST45RBP	Light with PL-3 connection	50
ST44RB	ST44RBP	Kit: ST45RB, A45GB & A45PB	10
ST45RGB	ST45RGBP	Light with male pin connection	50
ST46RB	ST46RBP	Light with reflex lens, PL-3 connection	50
ST46RKB	ST46RKBP	Kit: ST46RB, A45GB & A47PB	10
ST47RB	ST47RBP	Sealed flange light, PL-3 connection	50
ST47RKB	ST47RKBP	Kit: ST47RB & A45PB	10
YELLOW PARKING/TURN SIGNALS			
ST45AB	ST45ABP	Light	50
ST44AB	ST44ABP	Kit: ST45AB, A45GB & A45PB	10
ACCESSORIES			
A45GB	A45GBP	Grommet	50
A45PB	A45PBP	Pigtail, 3-wire	100
A47PB	A47PBP	Right angle pigtail, 3-wire	100
BK45BB	BK45BBP	Black steel bracket	10
RETAIL			
ST45RK		Kit: ST45RB, A45GB & A45PB, clam	6
ST45RS		Light only, clam	6

FMVSS	ST45RB: S T I P2 ST45AB: I P P2 ST46RB: S T I P2 A ST47RB: S T I P2
MATERIALS	Polycarbonate lens and housing
VOLT/AMP	12.8VDC - 2.4A Stop/Turn, 0.49A Tail/Parking
WT/DIMS	ST45/46: .221 lbs. / 4.25" x 4.25" x 2.063" ST47: .617 lbs. / 5.5" x 5.5" x 2"
WARRANTY	Three Year Warranty

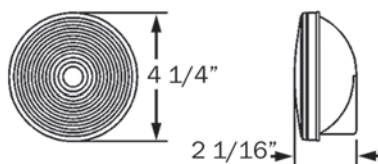

ST45AB/RB & 46RB

HOLE CUT-OUT:
4.5"

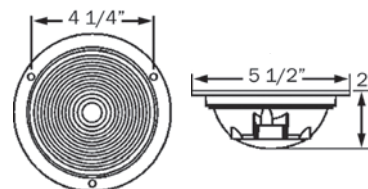

ST47RB

SEALED STOP/TURN/TAIL & PARKING/TURN SIGNALS

ST70/75 SERIES 6" Oval Sealed Lights

- Sonically sealed, waterproof
- Shock-proof socket guarantees long bulb life
- Accepts standard PL-3 plug
- Kits include grommet and plug

BULK P/N	POLYPACK P/N	DESCRIPTION	QTY
RED STOP/TURN/TAIL LIGHTS			
ST70RB	ST70RBP	Light	50
ST74RB	ST74RBP	Kit: ST70RB, A70GB & A45PB	50
ST70RBTK	ST70RBTKP	ST70RB light sealed to bracket	30
ST64RB	ST64RBP	Kit: ST70RB, A70GB & A47PB (plug attached to light)	50
ST65RB	ST65RBP	Kit: ST70RB, A70GB & A47PB	50
YELLOW SIGNAL LIGHTS			
ST70AB	ST70ABP	Parking/turn signal	50
ST74AB	ST74ABP	Kit: ST70AB, A70GB & A45PB	50
ST75AB	ST75ABP	Mid-ship turn signal/side marker	50
ST77AB	ST77ABP	Kit: ST75AB, A70GB & A45PB	50
ACCESSORIES			
A70GB	A70GBP	Grommet	50
A45PB	A45PBP	Pigtail, 3-wire	100
A47PB	A47PBP	Right angle pigtail, 3-wire	100
BK70BB	BK70BBP	Black steel bracket	10
RETAIL			
ST70RK		Kit: ST70RB, A70GB & A45PB, clam	6
ST70RS		Light only, clam	6

FMVSS	ST70RB: S T I P 2 ST70AB: I P P 2 ST75AB: E P 2 A
MATERIALS	Polycarbonate lens and housing
VOLT/AMP	12.8VDC - 2.4A Stop/Turn, 0.50A Tail/Parking
WT/DIMS	ST70: .265 lb. / 6.5" x 2.313" x 2.375" ST75: .221 lbs. / 6.5" x 2.313" x 2.75"
WARRANTY	Three Year Warranty



ST70RB



ST70RBTK



ST70AB



ST75AB

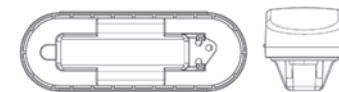
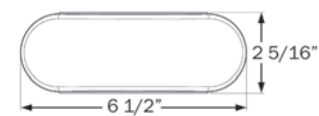

ST70

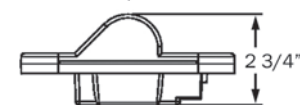
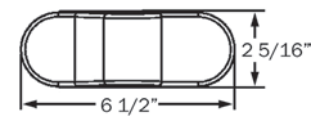

ST75AB

HOLE CUT-OUT: 6.85" X 2.5" (1.25" R)

SEALED STOP/TURN/TAIL & PARKING/TURN SIGNALS



ST33 SERIES Rectangular Sealed Lights



ST33RB

- Sonically sealed, waterproof
- Shock-proof socket guarantees long bulb life
- Accepts standard PL-3 plug
- Kits include grommet and plug



ST33AB

BULK P/N	POLYPACK P/N	DESCRIPTION	QTY
RED STOP/TURN/TAIL LIGHTS			
ST33RB	ST33RBP	Light	10
ST34RB	ST34RBP	Kit: ST33RB, A33GB & A47PB	50
YELLOW PARKING/TURN LIGHTS			
ST33AB	ST33ABP	Light	10
ACCESSORIES			
A33GB	A33GBP	Grommet	50
A45PB	A45PBP	Pigtail, 3-wire	100
A47PB	A47PBP	Right angle pigtail, 3-wire	100

SEALED STOP/TURN/TAIL & PARKING/TURN SIGNALS

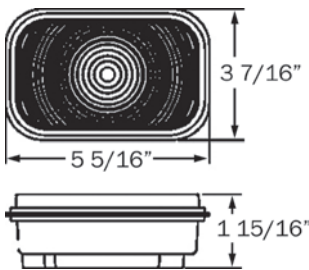

HOLE CUT-OUT: 5.453" X 3.578" (1" R)

FMVSS	ST33RB: S T I P 2 ST33AB: I P P 2
MATERIALS	Polycarbonate lens and housing
VOLT/AMP	12.8VDC - 2.19A Stop/Turn, 0.49A Tail/Parking
WT/DIMS	.265 lb. / 5.313" x 3.438" x 1.938"
WARRANTY	Three Year Warranty



ST40/42 SERIES Flush Mount Stop/Turn/Tail Lights

- Flush mount with acrylic lens, steel housing, gasket
- Replaceable lens and bulb
- Shock-proof socket guarantees long bulb life
- Hard wired

BULK P/N	POLYPACK P/N	DESCRIPTION	QTY
RED STOP/TURN/TAIL LIGHTS			
ST40RB	ST40RBP	Light, self grounding	50
ST42RB	ST42RBP	Light with reflex, ground wire	50
ST42RPG	-	Light with reflex, ground wire, .180 male bullets	50
ACCESSORIES			
A40SRB	A40SRBP	Snap-in lens retention ring	100
A40RB	A40RBP	Red lens	25
A42GB	A42GBP	Gasket for flange	100
A43RB	A43RB	Red lens with reflex	25
A2057B	A2057BP	2057 bulb	50
RETAIL			
ST40RS		Light, clam	6

FMVSS	ST40: S T I ST42: A I S T
MATERIALS	Acrylic lens, steel housing
VOLT/AMP	12.8VDC - 2.4A Stop/Turn, 0.49A Tail/Parking
WT/DIMS	.221 lbs. / 6.438" x 2.313" x 1.75"
WARRANTY	Three Year Warranty



ST40RB

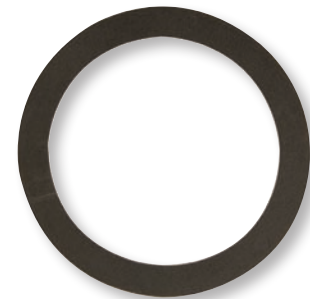

A42GB

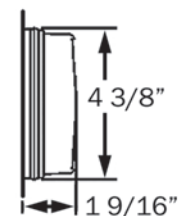
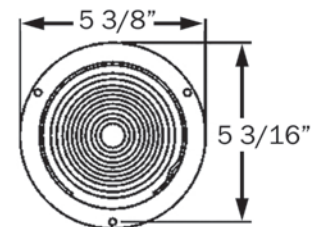

HOLE CUT-OUT: 4.5"

COMBINATION
TAIL LIGHTS & KITS



ST90 SERIES 7" Transit Lights for Surface Mount

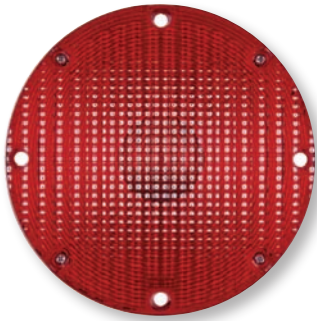

ST90RB

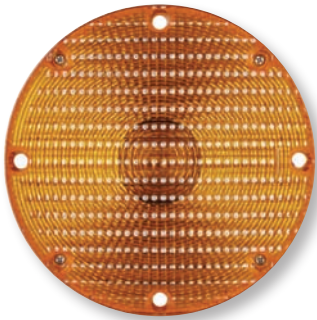

ST90AB

- Screw-on lens, easy to change bulb
- Surface mount on 6-1/4" centers
- Grounds through mounting hardware
- Acrylic lens, steel base plate

BULK P/N	POLYPACK P/N	DESCRIPTION	QTY
RED STOP/TAIL LIGHTS			
ST90RB	ST90RBP	Light, 1157 bulb	5
YELLOW TURN SIGNAL			
ST90AB	ST90ABP	Light, 1156 bulb	5
ACCESSORIES			
A90RB	A90RBP	Red lens	5
A90AB	A90ABP	Yellow lens	5
A1157B	A1157BP	1157 replacement bulb	50
A1156B	A1156BP	1156 replacement bulb	50

FMVSS	Red: S T I, Yellow: I
MATERIALS	Acrylic lens and steel housing
VOLT/AMP	12.8VDC - 2.4A Stop, 0.5A Tail/Parking
WT/DIMS	1.146 lbs. / 7.125" x 7.125" x 2.188"
WARRANTY	Three Year Warranty

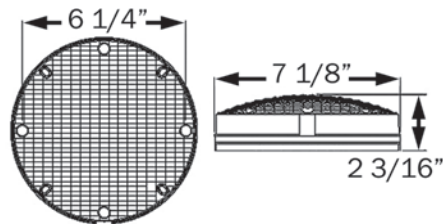

ST92 SERIES 7" Transit Warning Lights for Surface Mount

- School bus warning lamps
- Screw-on lens, easy to change halogen bulb
- Hard wired, includes lead and ground wire
- Acrylic lens, steel base plate

BULK P/N	POLYPACK P/N	DESCRIPTION	QTY
RED WARNING LIGHT			
ST92RB	ST92RBP	Warning light	5
YELLOW WARNING LIGHT			
ST92AB	ST92ABP	Warning light	5
RETAIL			
A700		12V H3 55W replacement bulb, clam	12

FMVSS	W W2
MATERIALS	Acrylic lens and steel housing
VOLT/AMP	12.8VDC - 4.6A
WT/DIMS	1.146 lbs. / 7.063" x 7.063" x 2.25"
WARRANTY	Three Year Warranty

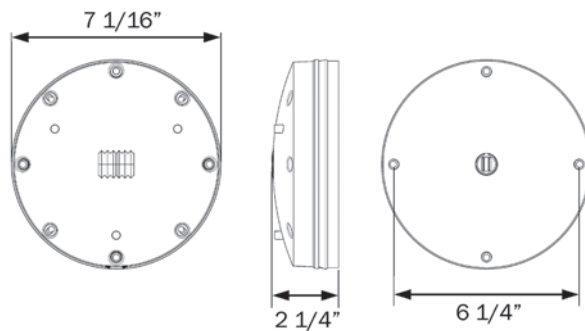

ST92RB



ST92AB

COMBINATION
TAIL LIGHTS & KITS



ST31 SERIES Weatherproof Surface Mount Light



ST31RB

- Snap-on lens, easy to change bulb
- Surface mount on 3-1/2" centers
- Hard wired, includes lead and ground wire
- Polycarbonate lens, steel base plate

BULK P/N	POLYPACK P/N	DESCRIPTION	QTY
RED STOP/TURN/TAIL LIGHTS			
ST31RB	ST31RBP	Light	50
ACCESSORIES			
A2057B	A2057BP	2057 replacement bulb	50
RETAIL			
ST31RS		Light, clam	12

FMVSS	ST I
MATERIALS	Polycarbonate lens and steel housing
VOLT/AMP	12.8VDC - 2.3A Stop/Turn, 0.90A Tail
WT/DIMS	.309 lb. / 4.563" x 2.5" x 1.75"
WARRANTY	Three Year Warranty

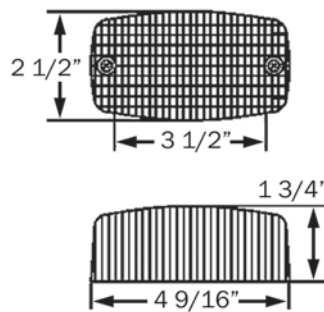

ST51/52/53 SERIES Pedestal Mount Lights

- Snap-on lens, easy to change bulb
- ST51/52 mount with single post and are self grounding; ST53 with dual post mounts on 2" centers and includes ground wire

BULK P/N	POLYPACK P/N	DESCRIPTION	QTY
RED - SINGLE FACE			
ST51RB	ST51RBP	Red, single face	10
YELLOW - DUAL FACE			
-	ST52AAP	Yellow, dual face	10
ST53AAB	ST53AABP	Square, yellow dual face with side marker/reflex, 1156 bulb	10
RED/YELLOW DUAL FACE			
ST52RB	ST52RBP	Dual face yellow/red stop/turn/tail light	10
ACCESSORIES			
A52RB	A52RBP	Red lens, round	25
A52AB	A52ABP	Yellow lens, round	25
A2057B	A2057BP	2057 replacement bulb	50
RETAIL			
ST51RS		Red stop/turn/tail light, clam	6
ST52AA		Dual yellow/yellow parking/turn, clam	6
ST52RA		Dual yellow/red stop/turn/tail light, clam	6

FMVSS	ST51/52:	S T I
	ST53AA:	Tail: S T I P, Side marker/reflex: P2 A
MATERIALS	ST51/52:	Acrylic lens and plastic housing
	ST53AA:	Acrylic lens and plastic housing
VOLT/AMP	ST51/52:	12.8VDC - 2.3A Stop/Turn, 1.2A Tail/Parking
	ST53AA:	12.8VDC - 2.3A Stop/Turn, .248A Marker
WT/DIMS	ST51/52:	.463 lb. / 4.313" x 4.313" x 2.375"
	ST53AA:	.794 lb. / 4.563" x 5" x 2.5"
WARRANTY	Three Year Warranty	



ST51/52

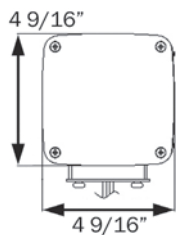
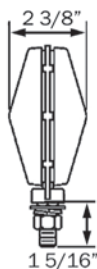

ST53AAB

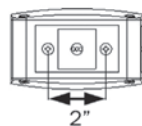

ST51RB



ST52AA



ST52RB



ST53AAB

COMBINATION
TAIL LIGHTS & KITS



ST24/25 SERIES Stud Mount Stop/Turn/Tail Lights



ST24RB



ST25RB

- Snap-on lens, easy to change bulb
- Stud mount on 2" centers
- Grounds through mounting hardware
- Acrylic lens, corrosion proof plastic housing
- Driver side light includes license illuminator

BULK P/N	POLYPACK P/N	DESCRIPTION	QTY
STOP/TURN/TAIL LIGHTS			
ST24RB	ST24RBP	Passenger side light	50
ST25RB	ST25RBP	Driver side light with license illuminator	50
ACCESSORIES			
A24RB	A24RBP	Red lens	25
A2057B	A2057BP	2057 replacement bulb	50

FMVSS	ST24RB: S T I P, ST25RB: S T I P L
MATERIALS	Acrylic lens and plastic housing
VOLT/AMP	12.8VDC - 2.5A Stop/Turn, 1.0A Tail
WT/DIMS	.309 lb. / 4.313" x 4.313" x 3.375"
WARRANTY	Three Year Warranty

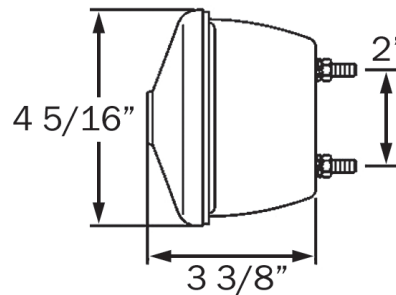

ST20/21 SERIES Surface Mount Stop/Turn/Tail Lights



- Screw-on lens, easy to change bulb
- Surface mount on 2" centers
- Grounds through mounting hardware
- Acrylic lens, steel housing
- Driver side light includes license illuminator



ST21RS



ST20RS

BULK P/N	POLYPACK P/N	DESCRIPTION	QTY
RETAIL			
ST20RS		Passenger side, clam	6
ST21RS		Driver side, clam	6
A20R		Red lens, slipover blister	12
ACCESSORIES			
A1157B	A1157BP	1157 replacement bulb	50

FMVSS	ST20RS: S T I, ST21RS: S T I L
MATERIALS	Acrylic lens and steel housing
VOLT/AMP	12.8VDC - 2.3A Stop/Turn, 0.90A Tail
WT/DIMS	.551 lb. / 3.875" x 3.875" x 3.063"
WARRANTY	Three Year Warranty

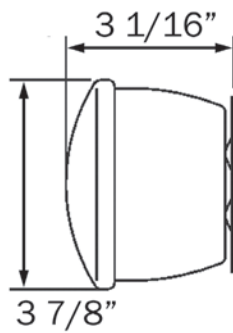

ST20RS

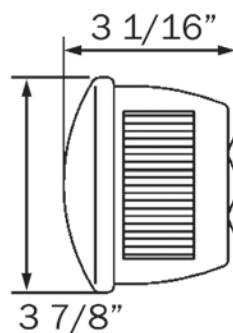

ST21RS

COMBINATION
TAIL LIGHTS & KITS



ST8/9 SERIES Universal Mount Combination Tail Lights



ST9RB



ST8RB



TL8RK

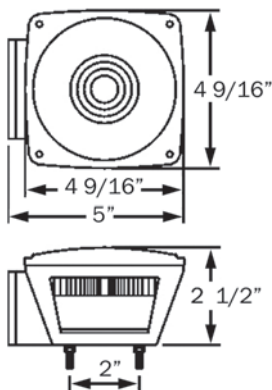

- Screw-on lens, easy to change bulbs
- Stud mount on 2" centers
- Grounds through mounting studs
- Shock-proof socket guarantees long bulb life
- Acrylic lens, corrosion proof plastic housing
- Passenger side light is 6-function: stop, turn, tail, rear reflex, side marker, and side reflex
- Driver side light also includes license illuminator
- Bulk models are designed with Plug-n-go connections for quick connect wiring
- Retail models are hard wired, self grounding

BULK P/N	POLYPACK P/N	DESCRIPTION	QTY
----------	--------------	-------------	-----

STOP/TURN/TAIL LIGHTS

ST8RB	ST8RBP	Passenger side light	50
ST9RB	ST9RBP	Driver side light with license illuminator	50
TL27BK	-	Kit: ST8RB, ST9RB, (2) MC36AB amber marker lights with reflex, LP10SB license plate bracket; 20-ft harness, box	1
TL29BK	-	Kit: ST8RB, ST9RB, (2) MC36AB amber marker lights with reflex, LP10SB license plate bracket; 25-ft harness, box	1

ACCESSORIES

A8RB	A8RBP	Tail light lens	50
A9RB	A9RBP	Side marker light lens	50
A1157B	A1157BP	1157 replacement bulb	50

RETAIL

ST8RS		Passenger side light, clam	6
ST9RS		Driver side with license illuminator, clam	6
TL8RK		Kit: ST8RB, ST9RB, license plate bracket, 20-ft harness, mounting hardware, clam	2
A8RK		Tail and side marker lens set, clam	12
A8R		Tail light lens, clam	12
A9R		Side marker light lens, clam	12

FMVSS	ST8RB: A S T, A P2, ST9RB: A S T, A P2, L
MATERIALS	Acrylic lens and plastic housing
VOLT/AMP	12.8VDC - 2.5A Stop/Turn, 1.0A Tail
WT/DIMS	.309 lb. / 4.563" x 4.563" x 2.875"
WARRANTY	Three Year Warranty

ST6/7 SERIES Submersible Universal Mount Combination Tail Lights

- Submersible design suitable for many applications
- Screw-on lens, easy to change bulbs
- Stud mount on 2" centers
- Grounds through mounting studs
- Shock-proof socket guarantees long bulb life
- Acrylic lens, corrosion proof plastic housing
- Passenger side light is 6-function: stop, turn, tail, rear reflex, side marker, and side reflex
- Driver side light also includes license illuminator

BULK P/N	POLYPACK P/N	DESCRIPTION	QTY
STOP/TURN/TAIL LIGHTS			
ST6RB	ST6RBP	Passenger side light	50
ST7RB	ST7RBP	Driver side light with license illuminator	50
ST6RPG	-	Passenger side light, 2-way plug	50
ST7RPG	-	Driver side light with license illuminator, 2-way plug	50
ACCESSORIES			
A8RB	A8RBP	Tail light lens	50
A9RB	A9RBP	Side marker light lens	25
A1157B	A1157BP	1157 replacement bulb	50
RETAIL			
ST6RS		Passenger side light, clam	6
ST7RS		Driver side with license illuminator, clam	6
TL5RK		Deluxe kit: ST6RB, ST7RB, (2) MC36AB amber marker lights with reflex, LP10SB license plate bracket, 25-ft harness, mounting hardware, clam	2
TL9RK		Kit: ST6RB, ST7RB, LP10SB license plate bracket, 25-ft harness, mounting hardware, clam	2
A8RK		Tail and side marker lens set, clam	12
A8R		Tail light lens, clam	12
A9R		Side marker light lens, clam	12
FMVSS	ST6RB: A S T, A P2, ST7RB: A S T, A P2, L		
MATERIALS	Acrylic lens and plastic housing		
VOLT/AMP	12.8VDC - 2.5A Stop/Turn, 1.0A Tail		
WT/DIMS	.309 lb. / 4.563" x 4.563" x 2.875"		
WARRANTY	Three Year Warranty		



ST7RB



ST6RB



TL5RK

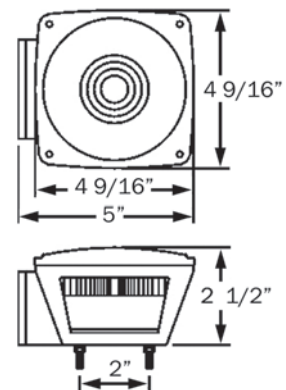

COMBINATION
TAIL LIGHTS & KITS



ST2/3 SERIES

Universal Mount Combination Tail Lights for Over 80" Applications



ST3RB



ST2RB

- Screw-on lens, easy to change bulbs
- Stud mount on 2" centers
- Grounds through mounting studs
- Shock-proof socket guarantees long bulb life
- Acrylic lens, corrosion proof plastic housing
- Passenger side light is 7-function: stop, turn, tail, rear clearance, rear reflex, side marker, and side reflex
- Driver side light also includes license illuminator
- Designed with Plug-n-go connections for quick connect wiring

BULK P/N	POLYPACK P/N	DESCRIPTION	QTY
STOP/TURN/TAIL LIGHTS			
ST2RB	ST2RBP	Passenger side light	50
ST3RB	ST3RBP	Driver side light with license illuminator	50
ACCESSORIES			
A8RB	A8RBP	Tail light lens	50
A2RB	A2RBP	Side marker light lens	25
A1157B	A1157BP	1157 replacement bulb	50

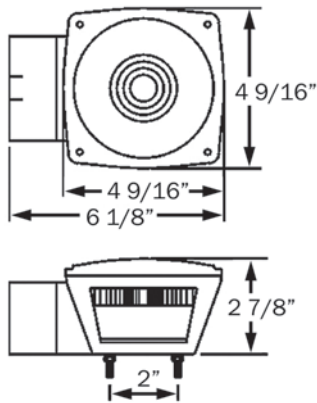

FMVSS	ST2RB: S T I A, P2 PC A, ST3RB: S T I A, P2 PC A, L
MATERIALS	Acrylic lens and plastic housing
VOLT/AMP	12.8VDC - 2.5A Stop/Turn, 1.0A Tail
WT/DIMS	.441 lb. / 6.125" x 4.563" x 2.875"
WARRANTY	Three Year Warranty

COMBINATION
TAIL LIGHTS & KITS

ST4/5 SERIES Submersible Universal Mount Combination Tail Lights for Over 80" Applications

- Submersible design suitable for many applications
- Screw-on lens, easy to change bulbs
- Stud mount on 2" centers
- Grounds through mounting studs
- Shock-proof socket guarantees long bulb life
- Acrylic lens, corrosion proof plastic housing
- Passenger side light is 7-function: stop, turn, tail, rear clearance, rear reflex, side marker, and side reflex
- Driver side light also includes license illuminator

BULK P/N	POLYPACK P/N	DESCRIPTION	QTY
STOP/TURN/TAIL LIGHTS			
ST4RB	ST4RBP	Passenger side light	50
ST5RB	ST5RBP	Driver side light with license illuminator	50
ACCESSORIES			
A8RB	A8RBP	Tail light lens	50
A2RB	A2RBP	Side marker light lens	25
A1157B	A1157BP	1157 replacement bulb	50
RETAIL			
ST4RS		Passenger side light, clam	6
ST5RS		Driver side with license illuminator, clam	6
TL6RK		Deluxe kit: ST4RB, ST5RB, LP10SB license plate bracket, 25-ft harness, mounting hardware, clam	2
TL60RK		Set: ST6RB, ST7RB, mounting hardware, clam	2
A8R		Tail light lens, clam	12
FMVSS	ST6RB: S T I A, A P2, ST7RB: S T I A, A P2, L		
MATERIALS	Acrylic lens and plastic housing		
VOLT/AMP	12.8VDC - 2.5A Stop/Turn, 1.0A Tail		
WT/DIMS	.441 lb. / 6.125" x 4.563" x 2.875"		
WARRANTY	Three Year Warranty		



ST5RB



ST4RB



TL6RK



TL60RK

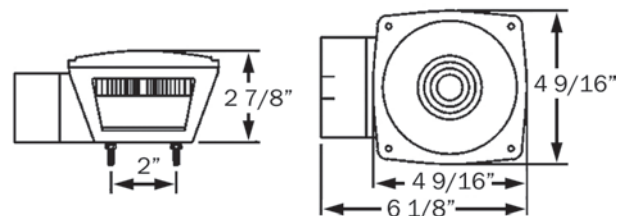

COMBINATION
TAIL LIGHTS & KITS



ST16/17 SERIES Waterproof Universal Mount Combination Tail Lights

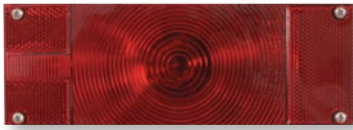

ST17RB

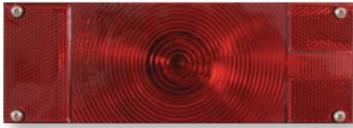

ST16RB

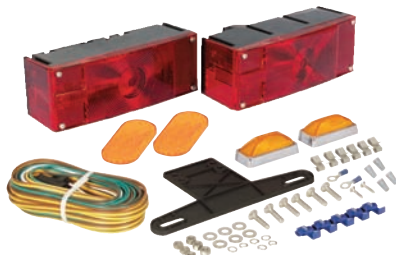



TL16RK

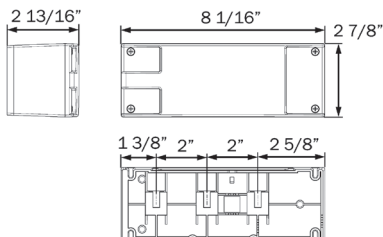

TL15RK



- Waterproof, low profile design for marine applications
- Replaceable lenses and bulbs
- Mount on 2" centers
- Includes separate ground wire with eyelet
- Acrylic lens, corrosion proof plastic housing
- Passenger side light is 7-function: stop, turn, tail, rear clearance, rear reflex, side marker, and side reflex
- Driver side light also includes license illuminator

BULK P/N	POLYPACK P/N	DESCRIPTION	QTY
STOP/TURN/TAIL LIGHTS			
ST16RB	ST16RBP	Passenger side light	20
ST17RB	ST17RBP	Driver side light with license illuminator	20
ST26RPG	-	Passenger side light, self grounding, 2-way plug	20
ST27RPG	-	Driver side light with license illuminator, self grounding, 2-way plug	20
ACCESSORIES			
A16RB	A16RBP	Tail light lens	50
A17RB	A17RBP	Side marker light lens	50
A2057B	A2057BP	2057 replacement bulb	50
RETAIL			
ST16RS		Passenger side light, clam	6
ST17RS		Driver side with license illuminator, clam	6
TL16RK		Deluxe kit: ST16RB, ST17RB, LP10SB license plate bracket, (2) MC91AB yellow marker lights with bases, (2) RE11AB yellow reflectors, 25-ft harness, stainless steel mounting hardware, clam	2
TL15RK		Kit: ST16RB, ST17RB, LP10SB license plate bracket, 25-ft harness, mounting hardware, clam	2
A16R		Tail light lens, clam	12
FMVSS		ST16RB: S T I A P2 PC; ST17RB: S T I A P2 PC, L	
MATERIALS		Acrylic lens and plastic housing	
VOLT/AMP		12.8VDC - 2.3A Stop/Turn, 0.9A Tail	
WT/DIMS		.661 lb. / 8.063" x 2.875" x 2.813"	
WARRANTY		Three Year Warranty	

COMBINATION
TAIL LIGHTS & KITS

ST36/37 SERIES Waterproof Universal Mount Combination Tail Lights

- Waterproof, low profile design for marine applications
- Screw-on lens, easy to change bulbs
- Mount on 2" centers
- Includes separate ground wire with eyelet
- Shock-proof socket guarantees long bulb life
- Acrylic lens, corrosion proof plastic housing
- Passenger side light is 7-function: stop, turn, tail, rear clearance, rear reflex, side marker, and side reflex
- Driver side light also includes license illuminator
- Stainless steel mounting hardware



ST37RB



ST36RB



TL36RK

BULK P/N	POLYPACK P/N	DESCRIPTION	QTY
----------	--------------	-------------	-----

STOP/TURN/TAIL LIGHTS

ST36RB	ST36RBP	Passenger side light	20
ST37RB	ST37RBP	Driver side light with license illuminator	20
ST36RPG	ST36RPGP	Passenger side light, self grounding, 2-way plug	20
ST37RPG	ST37RPGP	Driver side light with license illuminator, self grounding, 2-way plug	20
ST66RPG	ST66RPGP	Passenger side light, 3-way plug	20
ST67RPG	ST67RPGP	Driver side light with license illuminator, 3-way plug	20

ACCESSORIES

A39RB	A39RBP	Tail light lens	10
A37RB	A37RBP	Side marker light lens	50
A1157B	A1157BP	1157 replacement bulb	50

RETAIL

ST36RS		Passenger side light, clam	6
ST37RS		Driver side with license illuminator, clam	6
TL36RK		Deluxe kit: ST36RB, ST37RB, LP10SB license plate bracket, (2) MC91AB yellow marker lights with bases, 25-ft harness, stainless steel mounting hardware, clam	2
A36R		Tail and marker light lenses, clam	12

FMVSS	ST36RB: S T I A P2, A P2; ST37RB: S T I A P2, A P2, L
MATERIALS	Acrylic lens and plastic housing
VOLT/AMP	12.8VDC - 2.3A Stop/Turn, 0.9A Tail
WT/DIMS	.992 lb. / 7.875" x 3.25" x 2.875"
WARRANTY	Three Year Warranty

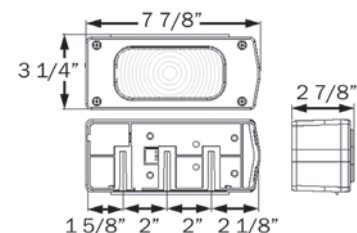

COMBINATION
TAIL LIGHTS & KITS



ST56/57 SERIES Submersible Universal Mount Combination Tail Lights for Over 80" Applications



ST57RS



ST56RS

- Waterproof design for marine applications
- Shock mount guarantees long bulb life
- Mount on 2" centers
- Includes separate ground wire with eyelet
- Acrylic lens, corrosion proof plastic housing
- Passenger side light is 7-function: stop, turn, tail, rear clearance, rear reflex, side marker, and side reflex
- Driver side light also includes license illuminator
- Stainless steel mounting hardware

COMBINATION
TAIL LIGHTS & KITS

BULK P/N	POLYPACK P/N	DESCRIPTION	QTY
RETAIL			
ST56RS		Passenger side light, clam	6
ST57RS		Driver side with license illuminator, clam	6
ACCESSORIES			
A1157B	A1157BP	1157 replacement bulb	50
A194B	A194BP	194 replacement bulb	100

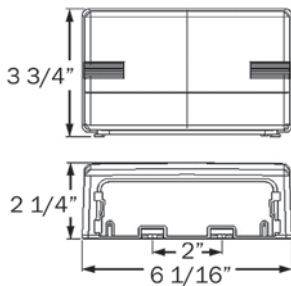

FMVSS	ST56RB: S2 T2 I6 PC A; ST57RB: S2 T2 I6 PC A, L
MATERIALS	Acrylic lens and plastic housing
VOLT/AMP	12.8VDC - 2.3A Stop/Turn, 0.9A Tail
WT/DIMS	.639 lb. / 6.063" x 3.75" x 2.25"
WARRANTY	Three Year Warranty

ST60 SERIES Universal Mount Combination Tail Lights



- Stud mount stop/turn/tail light with back-up and license illuminator built in
- Screw-on lens, easy to change bulbs
- Grounds through mounting studs
- Shock-proof socket guarantees long bulb life
- Acrylic lens, corrosion proof plastic housing



ST60RB

BULK P/N	POLYPACK P/N	DESCRIPTION	QTY
STOP/TURN/TAIL LIGHTS			
ST60RB	ST60RBP	Combination tail light	20
ACCESSORIES			
A60RB	A60RBP	Tail light lens	25
A2057B	A2057BP	2057 replacement bulb	50
A1156B	A1156BP	1156 replacement bulb	50
RETAIL			
ST60RS		Combination tail light, clam	6

FMVSS	STAIR
MATERIALS	Acrylic lens and plastic housing
VOLT/AMP	12.8VDC - 2.3A Stop/Turn, 0.9A Tail
WT/DIMS	.992 lb. / 5.75" x 6.625" x 2.813"
WARRANTY	Three Year Warranty

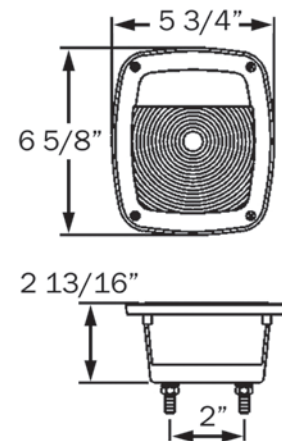

COMBINATION
TAIL LIGHTS & KITS



TL22RK Magnetic Mount Towing Light Kit



TL22RK



- Magnetic mount towing light kit
- Pair of DOT compliant stop/turn/tail lights
- 20-ft wishbone style wiring harness and 4-ft trunk connector with 4-way flat plug
- Replaceable lens and bulb

BULK P/N	POLYPACK P/N	DESCRIPTION	QTY
RETAIL			
TL22RK		Towing light kit	2
ACCESSORIES			
A52RB	A52RBP	Tail light lens	25
A2057B	A2057BP	2057 replacement bulb	50

FMVSS	S T I
MATERIALS	Acrylic lens and plastic housing
VOLT/AMP	12.8VDC - 2.3A Stop/Turn, 0.9A Tail
WT/DIMS	3.53 lbs. / 7" x 4" x 2.125"
WARRANTY	Three Year Warranty

BU11CS Back-Up Light

- Single wire, grounds through mounting hardware
- Replaceable bulb (1156)

BULK P/N	POLYPACK P/N	DESCRIPTION	QTY
RETAIL			
BU11CS		Back-up light, chrome housing	12

FMVSS	R
MATERIALS	Polycarbonate lens and plastic housing
VOLT/AMP	12.8VDC - 0.4A
WT/DIMS	.221 lbs. / 3.25" x 3.25" x 1.938"
WARRANTY	Three Year Warranty



BU11CS

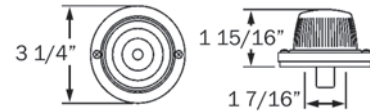

BU31 SERIES Surface Mount Back-Up Light

- Single wire, grounds through mounting hardware
- Replaceable bulb (1156)

BULK P/N	POLYPACK P/N	DESCRIPTION	QTY
BACK-UP LIGHT			
BU31CB	BU31CBP	Back-up light	50

FMVSS	R
MATERIALS	Polycarbonate lens, steel base plate
VOLT/AMP	12.8VDC - 0.4A
WT/DIMS	.441 lbs. / 4.563" x 2.5" x 1.75"
WARRANTY	Three Year Warranty



BU31CB

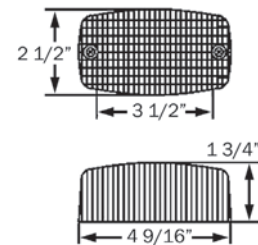

BU41 SERIES Flange Mount Back-Up Light

- Hard wired, includes both lead and ground wire
- Replaceable bulb (1056)

BULK P/N	POLYPACK P/N	DESCRIPTION	QTY
BACK-UP LIGHT			
BU41CB	BU41CBP	Back-up light	50

FMVSS	R
MATERIALS	Acrylic lens, steel housing
VOLT/AMP	12.8VDC - 1.182A
WT/DIMS	.441 lbs. / 5.375" x 5.375" x 1.563"
WARRANTY	Three Year Warranty



BU41CB

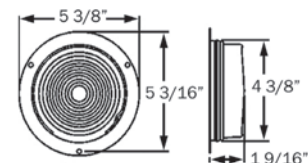

DOT COMPLIANT
BACK-UP LIGHTS



BU33/45/70 SERIES Sealed Back-Up Lights

- 4" round, 6" oval and rectangular models
- Sonically sealed, waterproof
- Flush mount design accepts standard two-way plug
- Shock proof socket guarantees long bulb life
- Kits include grommet and plug



BU45CB

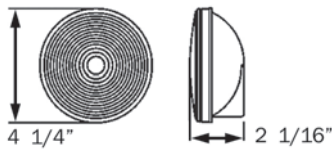

HOLE CUT-OUT: 4.5"



BU70CB

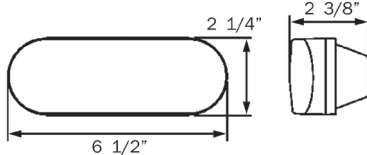

HOLE CUT-OUT: 6.85" x 2.5" (1.25" R)



BU33CB

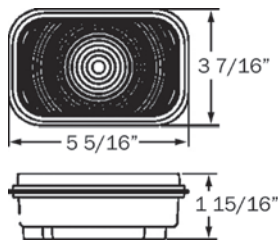

HOLE CUT-OUT: 5.453" x 3.578" (1" R)

BULK P/N	POLYPACK P/N	DESCRIPTION	QTY
4" ROUND BACK-UP LIGHTS			
BU45CB	BU45CBP	Back-up light	50
BU44CB	BU44CBP	Kit: BU45CB, A45GB & A45CB	50
BU49CB	BU49CBP	Kit: BU45CB & A45GB	10
6" OVAL BACK-UP LIGHTS			
BU70CB	BU70CBP	Back-up light	50
BU74CB	BU74CBP	Kit: BU70CB, A70GB & A45CB	50
BU64CB	BU64CBP	Kit: BU70CB, A70GB & A49PB (pigtail attached to light)	50
BU65CB	BU65CBP	Kit: BU70CB, A70GB & A49PB	50
RECTANGULAR BACK-UP LIGHTS			
BU33CB	BU33CBP	Back-up light	10
BU34CB	BU34CBP	Kit: BU33CB, A33GB & A45CB	50
BU33CRXLB	-	Back-up light with red reflex	20
ACCESSORIES			
A45GB	A45GBP	4" round grommet	50
A70GB	A70GBP	6" oval grommet	50
A33GB	A33GBP	Rectangular grommet	50
A45CB	A45CBP	Straight two-wire pigtail	100
A49PB	A49PBP	Right angle two-wire pigtail	100
FMVSS	R		
MATERIALS	Polycarbonate lens and housing		
VOLT/AMP	BU45:	12.8VDC - 2.182A	
	BU70:	12.8VDC - 0.4A	
	BU33:	12.8VDC - 1.6A	
WT/DIMS	BU45:	.176 lbs. / 4.25" x 4.25" x 2.063"	
	BU70:	.265 lbs. / 6.5" x 2.25" x 2.375"	
	BU33:	.441 lbs. / 5.313" x 3.438" x 1.938"	
WARRANTY	Three Year Warranty		



BU33CRXLB

DOT COMPLIANT
BACK-UP LIGHTS

M1 SERIES Millennium Series™ 6.5” Marker/Clearance Lights

- Replaceable lens and bulb
- Hard wired, includes separate ground wire
- Available with .180 male bullets or metripack connector
- Choose from light only or kit with chrome bezel

BULK P/N	POLYPACK P/N	DESCRIPTION	QTY
YELLOW			
00212351B	00212351P	12V, .180 bullets	20
00212331B	00212331P	12V Kit: .180 bullets, bezel	20
00212031B	00212031P	24V Kit: .180 bullets, bezel	20
00212362B	00212362P	12V, Metripack connector	20
00212342B	00212342P	12V Kit: Metripack connector, bezel	20
RED			
00212353B	00212353P	12V, .180 bullets	20
00212333B	00212333P	12V Kit: .180 bullets, bezel	20
ACCESSORIES			
00212317B	00212327P	Bezel	100/20
00212011B	00212005P	Socket with 193 bulb, .180 bullets	100/20
00212010B	00212013P	24V 464E Bulb	100/20

FMVSS	P2
MATERIALS	Polycarbonate lens, housing and bezel
VOLT/AMP	12.8VDC - 0.33A; 24.0VDC - 0.17A
WARRANTY	Three Year Warranty

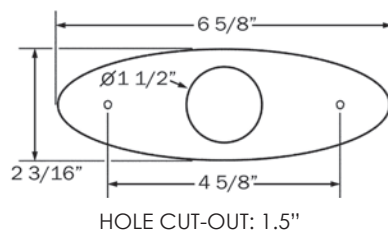

M1 WITH BEZEL



M1 WITH BEZEL



MILLENNIUM SERIES
MARKER/CLEARANCE LIGHTS



M3 WITH BEZEL



M3 WITH BEZEL



M3 CLEAR LENS WITH BEZEL



M3 SERIES Millennium Series™ 3" Marker/Clearance Lights

- Replaceable lens and bulb
- Hard wired, includes separate ground wire
- Molded .180 male bullets
- Choose from light only or kit with chrome bezel

BULK P/N	POLYPACK P/N	DESCRIPTION	QTY
YELLOW			
00212251B	00212251P	.180 bullets	20
00212231B	00212231P	Kit: .180 bullets, bezel	20
RED			
00212253B	00212253P	.180 bullets	20
00212233B	00212233P	Kit: .180 bullets, bezel	20
CLEAR			
00212259B	00212259P	.180 bullets	20
00212239B	00212239P	Kit: .180 bullets, bezel	20
ACCESSORIES			
00212223B	00212293P	Yellow replacement lens	500/20
00212224B	00212294P	Red replacement lens	500/20
00212217B	00212227P	Bezel	500/20
00212011B	00212005P	Socket with 193 bulb, .180 bullets	100/20

FMVSS	P2
MATERIALS	Polycarbonate lens, housing and bezel
VOLT/AMP	12.8VDC - 0.33A
WARRANTY	Three Year Warranty

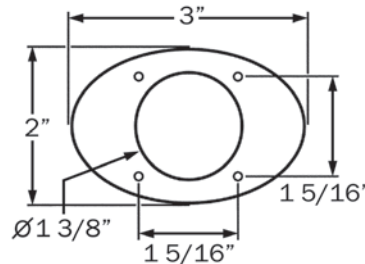

HOLE CUT-OUT: 1.375"

MILLENNIUM SERIES
MARKER/CLEARANCE LIGHTS

MC25/27 SERIES 2" & 2.5" Sealed Beehive Style Marker/Clearance Lights

- Sonically sealed, waterproof
- Clearance, side marker, or rear tracking light applications
- Accepts standard two-pin PL-10 plug



MC25AB



MC25RB



MC27AB



MC27RB

BULK P/N	POLYPACK P/N	DESCRIPTION	QTY
YELLOW			
MC25AB	MC25ABP	2" light	20
MC27AB	MC27ABP	2.5" light	20
RED			
MC25RB	MC25RBP	2" light	20
MC27RB	MC27RBP	2.5" light	20
ACCESSORIES			
A46PB	A46PBP	Straight PL-10 plug, 6" lead	100
A86PB	A86PBP	Straight PL-10 plug, 18" lead	100
A54GB	A54GBP	2" Flush mount grommet	100
A54GK	A54GKP	2" Kit: A54GB and A46PB	100
A55CB	A55CBP	2" Chrome trim ring	20
A55GB	A55GBP	2.5" Flush mount grommet (open back)	50
A56GB	A56GBP	2.5" Recess mount grommet (closed back)	100
A57GB	A57GBP	2.5" Recess mount grommet (open back)	50
A55GK	A55GKP	2.5" Kit: A55GB and A46PB	100
A57GK	A57GKP	2.5" Kit: A57GB and A46PB	100
A57CB	A57CBP	2.5" Chrome trim ring	20
BK5557GB	BK5557GBP	2"/2.5" Cam-on mounting bracket	50

FMVSS	P2
MATERIALS	Polycarbonate lens and housing
VOLT/AMP	12.8VDC - 0.2A
WT/DIMS	MC25: .088 lbs. / 2" x 2" x 1.75" MC27: .110 lbs. / 2.5" x 2.5" x 2.313"
WARRANTY	Three Year Warranty

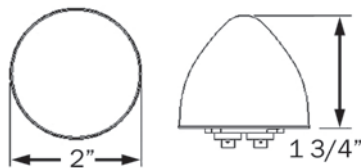

MC25 SERIES
HOLE CUT-OUT: 2.313"

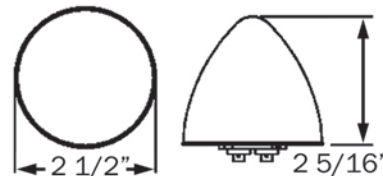

MC27 SERIES
HOLE CUT-OUT: 2.75"

SEALED MARKER/
CLEARANCE LIGHTS



MC52 SERIES

2" Round Sealed Recess Flange Mount Marker/Clearance Lights

- Sonically sealed, waterproof light for recess mount
- Accepts standard two-pin PL-10 plug
- Available in yellow and red models, with black or reflex flange
- Reflex flange model meets SAE "A" requirements for conspicuity



MC52AB



MC52RB

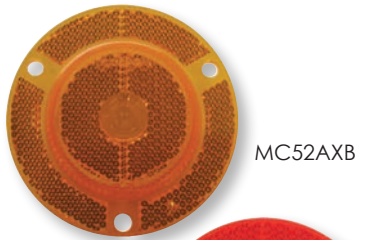

MC52AXB



MC52RXB

BULK P/N	POLYPACK P/N	DESCRIPTION	QTY
YELLOW			
MC52AB	MC52ABP	Yellow, black flange	50
MC52AXB	MC52AXBP	Yellow, reflex lens and flange	50
RED			
MC52RB	MC52RBP	Red, black flange	50
MC52RXB	MC52RXBP	Red, reflex lens and flange	50
ACCESSORIES			
A46PB	A46BPB	Straight PL-10 plug, 6" lead	100
A86PB	A86BPB	Straight PL-10 plug, 18" lead	100
A3TRSSB	-	Stainless steel flange cover	100

FMVSS	Black flange: P2 Reflex flange: A P2
MATERIALS	Polycarbonate lens and housing
VOLT/AMP	12.8VDC - 0.2A
WT/DIMS	Black flange: .066 lbs. / 2.938" x 2.938" x .813" Reflex flange: .066 lbs. / 2.984" x 2.984" x .75"
WARRANTY	Three Year Warranty

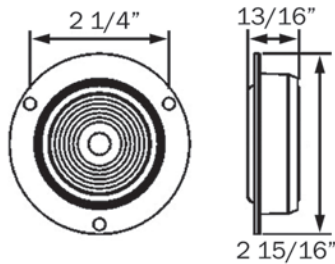

MC52 Black Flange

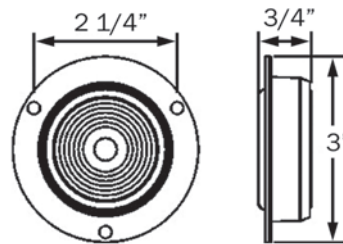

MC52 Reflex Flange

SEALED MARKER/
CLEARANCE LIGHTS

MC53 & MC54 SERIES 2" Sealed Marker/Clearance Lights



- Sonically sealed, waterproof
- Accept standard two-pin PL-10 plugs
- Available in yellow, red, and yellow ABS models
- Available in recess and surface mount models

BULK P/N	POLYPACK P/N	DESCRIPTION	QTY
YELLOW			
MC53AB	MC53ABP	Recess mount	50
MC53ABSB	MC53ABSBP	Recess mount "ABS"	50
MC54AB	MC54ABP	Flange surface mount	50
MC505ABSB	MC505ABSBP	Flange surface mount "ABS"	50
RED			
MC53RB	MC53RBP	Recess mount	50
MC54RB	MC54RBP	Flange surface mount	50
ACCESSORIES			
A46PB	A46PBP	Straight PL-10 plug, 6" lead	100
A86PB	A86PBP	Straight PL-10 plug, 18" lead	100
A54GB	A54GBP	2" Flush mount grommet	100
A54GK	A54GKP	2" Kit: A54GB and A46PB	100
A55CB	A55CBP	2" Chrome trim ring	20
BK5557GB	BK5557GBP	Cam-on mounting bracket	50
RETAIL			
MC53AS		Yellow recess mount light, clam	12
MC53RS		Red recess mount light, clam	12

FMVSS	P2 PC
MATERIALS	Polycarbonate lens and housing
VOLT/AMP	12.8VDC - 0.2A
WT/DIMS	MC53: .066 lbs. / 2" x 2" x .688" MC54/505: .066 lbs. / 2.938" x 2.938" x .813"
WARRANTY	Three Year Warranty

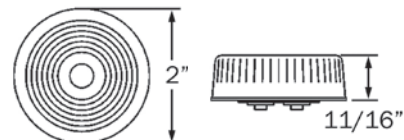
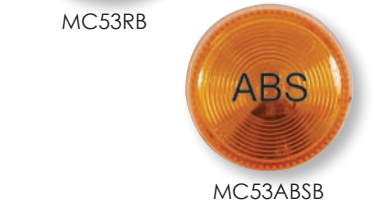

HOLE CUT-OUT: 2.313"

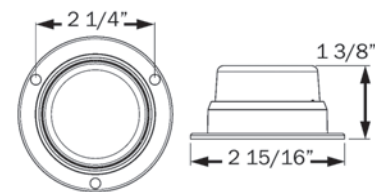

SURFACE MOUNT

SEALED MARKER/
CLEARANCE LIGHTS



MC55 & MC57 SERIES 2.5" Sealed Marker/Clearance Lights for Recess Mount



MC55AB



MC55RB

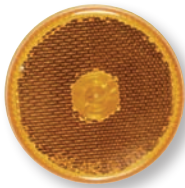

MC57AB
MC57AS



MC57RB
MC57RS

SAE A REFLEX
P2 RATED

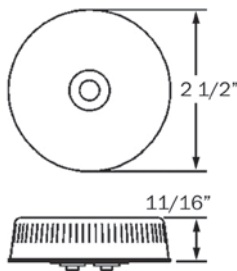

HOLE CUT-OUT: 2.75"

- Sonically sealed, waterproof design for recess mount
- Accept standard two-pin PL-10 plug
- MC55 series lights are PC rated
- MC57 series lights feature built-in reflex

BULK P/N	POLYPACK P/N	DESCRIPTION	QTY
YELLOW			
MC55AB	MC55ABP	PC rated light	50
-	MC55ABKP	Kit: MC55AB, A55GB & A46PB	50
MC57AB	MC57ABP	P2 rated light with reflex	50
RED			
MC55RB	MC55RBP	PC rated light	50
-	MC55RBKP	Kit: MC55RB, A55GB & A46PB	50
MC57RB	MC57RBP	P2 rated light with reflex	50
ACCESSORIES			
A46PB	A46PBP	Straight PL-10 plug, 6" lead	100
A86PB	A86PBP	Straight PL-10 plug, 18" lead	100
A55GB	A55GBP	Flush mount grommet, open back	50
A56GB	A56GBP	Recess mount grommet, closed back	100
A57GB	A57GBP	Recess mount grommet, open back	50
A55GK	A55GKP	Kit: A55GB & A46PB	100
A57GK	A57GKP	Kit: A57GB & A46PB	100
A57CB	A57CBP	Chrome trim ring	20
BK5557GB	BK5557GBP	Cam-on mounting bracket	50
RETAIL			
MC57AS		Yellow light with reflex, clam	12
MC57RS		Red light with reflex, clam	12

FMVSS	MC55: P2 PC MC57: A P2
MATERIALS	Polycarbonate lens and housing
VOLT/AMP	12.8VDC - 0.2A
WT/DIMS	.066 lbs. / 2.5" x 2.5" x .688"
WARRANTY	Three Year Warranty

SEALED MARKER/
CLEARANCE LIGHTS



MC56 & MC59 SERIES 2.5" Sealed Recess Flange Mount Marker/Clearance Lights

- Sonically sealed, waterproof light for recess mount
- Accepts standard two-pin PL-10 plug
- MC59 series lights include reflex meeting SAE "A" conspicuity requirement

BULK P/N	POLYPACK P/N	DESCRIPTION	QTY
YELLOW			
MC56AB	MC56ABP	Recess flange mount	50
MC59AFB	MC59AFBP	Recess flange mount, reflex lens	50
RED			
MC56RB	MC56RBP	Recess flange mount	50
MC59RFB	MC59RFBP	Recess flange mount, reflex lens	50
ACCESSORIES			
A46PB	A46PBP	Straight PL-10 plug, 6" lead	100
A86PB	A86PBP	Straight PL-10 plug, 18" lead	100

FMVSS	MC56: P2 MC59: A P2
MATERIALS	Polycarbonate lens and housing
VOLT/AMP	12.8VDC - 0.2A
WT/DIMS	.11 lb. / 3.438" x 3.438" x .938"
WARRANTY	Three Year Warranty



MC56AB



MC56RB



MC59AFB



MC59RFB

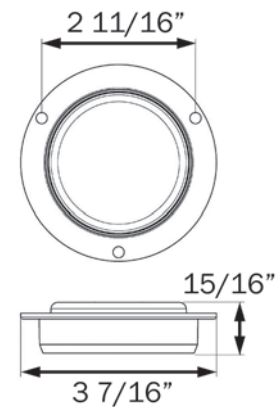

HOLE CUT-OUT: 2.75"

SEALED MARKER/
CLEARANCE LIGHTS



MC61ABKB Sealed Marker/Clearance Light and Reflector in Elevated Bracket



MC61ABKB

- Sonically sealed, waterproof
- PC rated light fulfills front side marker requirement when properly mounted on a 15 degree angle
- Corrosion proof, surface mount wedge base
- Single wire design grounds through mounting hardware

SEALED MARKER/
CLEARANCE LIGHTS

BULK P/N	POLYPACK P/N	DESCRIPTION	QTY
LIGHT/REFLECTOR ASSEMBLY			
MC61ABKB	MC61ABKBP	Light & reflector in bracket	20
ACCESSORIES			
A61EZPG	-	Lead wire with .180 male bullet	100
BK61AB	-	Bracket with reflector	20

FMVSS	Light: P2 PC; Reflector: A
MATERIALS	Polycarbonate lens and housing; Acrylic reflector
VOLT/AMP	12.8VDC - 0.2A
WT/DIMS	.066 lbs. / 6.687" x 1.5" x 1.625"
WARRANTY	Three Year Warranty

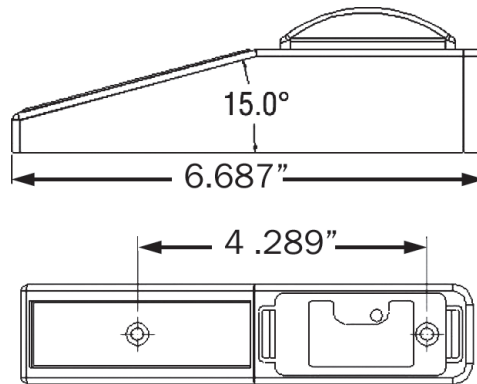

MC65/67 & BA65 SERIES Sealed Fender Lights

- Sonically sealed, waterproof
- PC rated design includes two bulbs
- Multiple mounting and wiring options available
- Single wire design grounds through mounting hardware
- Two-wire design includes both lead and ground wires

BULK P/N	POLYPACK P/N	DESCRIPTION	QTY
AMBER/RED FENDER LIGHT			
MC65ARB	MC65ARBP	Light only	50
MC67ARB	MC67ARBP	Kit: MC65ARB & A65PB bracket/plug	50
AMBER/RED FENDER LIGHT ASSEMBLIES			
BA65ARLB	BA65ARLBP	Fender light assembly, left side: MC65AB & MC65RB in fender mount bracket	25
BA65ARRB	BA65ARRBP	Fender light assembly, right side: MC65AB & MC65RB in fender mount bracket	25
ACCESSORIES			
A67BB	A67BBP	Fender bracket, black	50
A67GB	A67GBP	Fender bracket, gray	50
A67CVB	A67CVBP	Curved fender bracket, gray	50
A65B	A65BP	Black bracket	50
A65P	A65PP	Single wire plug, .156 male bullet	50
A65PB	A65PBP	Kit: A65B black bracket & A65P plug	50
A66PB	A66PBP	Kit: Gray bracket & A65P plug	50
A67CB	A67CBP	Kit: Chrome bracket & A65P plug	50
A68PB	A68PBP	Kit: Black bracket & 2-wire plug	50

For more details on mounting and wiring accessories, see Accessories section at back of catalog.

FMVSS	MC65ARB: P2
	BA65: P2 P3 PC2
MATERIALS	MC65: Polycarbonate lens and housing
	BA65: Polycarbonate lens and housing, plastic bracket
VOLT/AMP	MC65: 12.8VDC - 0.689A
	BA65: 12.8VDC - 0.8A
WT/DIMS	MC65: .066 lbs. / 3.938" x 1.25" x .875"
	BA65: .375 lbs. / 9.188" x 4.688" x 1.875"
WARRANTY	Three Year Warranty



MC65ARB

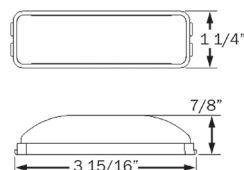

MC67ARB

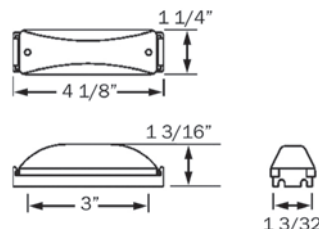

BA65ARLB

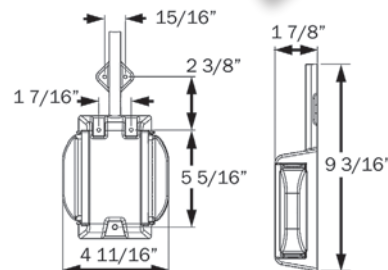

SEALED MARKER/
CLEARANCE LIGHTS



MC65/67 SERIES Sealed Marker/Clearance Lights



- Sonically sealed, waterproof
- PC rated design includes two bulbs
- Multiple mounting and wiring options available
- Single wire design grounds through mounting hardware
- Two-wire design includes both lead and ground wires

MC65AB





MC65RB

MC67AB
MC67AK



MC67RB
MC67RK

BULK P/N	POLYPACK P/N	DESCRIPTION	QTY
YELLOW			
MC65AB	MC65ABP	Light only	50
MC67AB	MC67ABP	Kit: MC65AB & A65PB	50
RED			
MC65RB	MC65RBP	Light only	50
MC67RB	MC67RBP	Kit: MC65RB & A65PB	50
ACCESSORIES			
A65B	A65BP	Black bracket	50
A65P	A65PP	Single wire plug, .156 male bullet	50
A65PB	A65PBP	Kit: A65B black bracket & A65P plug	50
A66PB	A66PBP	Kit: Gray bracket & A65P plug	50
A67CB	A67CBP	Kit: Chrome bracket & A65P plug	50
A68PB	A68PBP	Kit: Black bracket & 2-wire plug	50
For more details on mounting and wiring accessories, see Accessories section at back of catalog.			
RETAIL			
MC67AK		Yellow kit: MC65AB & A65PB, clam	12
MC67RK		Red kit: MC65RB & A65PB, clam	12

FMVSS	P2 P3 PC2
MATERIALS	Polycarbonate lens and housing
VOLT/AMP	12.8VDC - 0.4A
WT/DIMS	.066 lbs. / 3.938" x 1.25" x .875"
WARRANTY	Three Year Warranty

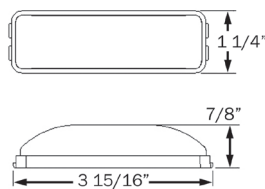

MC65

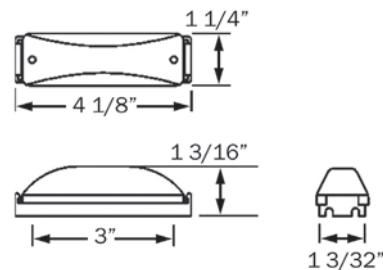

MC67

SEALED MARKER/
CLEARANCE LIGHTS

MC91 SERIES

Sealed Marker/Clearance Lights



- Sonically sealed, waterproof
- PC rated design
- Multiple mounting and wiring options available
- Single wire design grounds through mounting hardware
- Two-wire design includes both lead and ground wires

BULK P/N	POLYPACK P/N	DESCRIPTION	QTY
YELLOW			
A91AB	A91ABP	Light only	100
MC91AB	MC91ABP	Kit: A91AB, A91CB & A91LW	50
MC92AB	MC92ABP	Kit: A91AB, A91BB & A91LW	50
RED			
A91RB	A91RBP	Light only	100
MC92RB	MC92RBP	Kit: A91RB, A91BB & A91LW	50
ACCESSORIES			
A46PB	A46PBP	2-wire plug, 6" lead	100
A86PB	A86PBP	2-wire plug, 18" lead	100
A91LW	A91LWP	1-wire plug, 12" lead	100
A91BB	A91BBP	Black base, self grounding	100
A91BOB	A91BOBP	Black base, open back	100
A91CB	A91CBP	Chrome base, self grounding	100
A91OB	A91OBP	Chrome base, open back	100
A91GB	A91GBP	Grommet	100
A82BB	A82BBP	Black base, open back (use with A90CB)	50
A90CB	A90CBP	Chrome cover for A82BB	50
RETAIL			
MC90AS		Yellow light only, clam	12
MC90RS		Red light only, clam	12
MC91AS		Yellow light kit: A91AB, A91CB chrome base, A91LW single wire plug, clam	12
MC91RS		Red light kit: A91RB, A91CB chrome base, A91LW single wire plug, clam	12
MC92AS		Yellow light kit: A91AB, A91BB black base, A91LW single wire plug, clam	12
MC92RS		Red light kit: A91RB, A91BB black base, A91LW single wire plug, clam	12

FMVSS	P2 PC
MATERIALS	Polycarbonate lens and housing
VOLT/AMP	12.8VDC - 0.2A
WT/DIMS	.066 lbs. / 2.5" x 1.188" x .875"
WARRANTY	Three Year Warranty

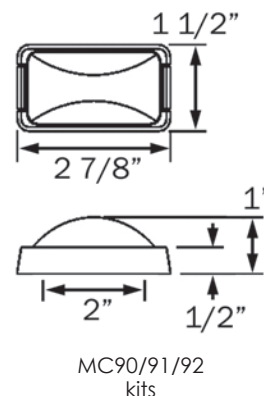
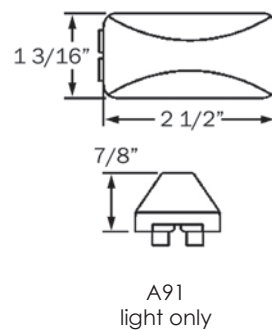

SEALED MARKER/
CLEARANCE LIGHTS



MC11AB



MC11RB



UL11BS

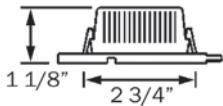
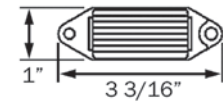

MC11AK

MC11 SERIES Mini Marker/Clearance Lights

- Surface mount on 2-3/4" centers
- Single wire design grounds through mounting hardware
- Snap-on lens, replaceable bulb

BULK P/N	POLYPACK P/N	DESCRIPTION	QTY
YELLOW			
MC11AB	MC11ABP	Yellow, black base	50
RED			
MC11RB	MC11RBP	Red, black base	50
ACCESSORIES			
A11AB	A11ABP	Yellow replacement lens	50
A11RB	A11RBP	Red replacement lens	50
A194B	A194BP	194 replacement bulb	100
RETAIL			
MC11AS		Yellow light, clam	12
MC11RS		Red light, clam	12
MC11AK		(6) MC11AB, hardware, connectors, clam	6
UL11BS		Blue utility light, clam	12
FMVSS	P2 (except UL11BS)		
MATERIALS	Acrylic lens, ABS housing		
VOLT/AMP	12.8VDC - 0.4A		
WT/DIMS	.044 lbs. / 3.188" x 1" x 1.125"		
WARRANTY	Three Year Warranty		



MC30AB

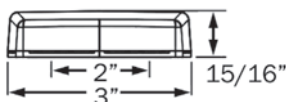
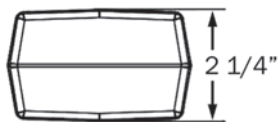

MC30 SERIES Marker/Clearance Light with Reflex

- Surface mount on 2" centers
- Plug-n-go design for quick connection to power and ground
- Snap-on lens, replaceable bulb

BULK P/N	POLYPACK P/N	DESCRIPTION	QTY
YELLOW			
MC30AB	MC30ABP	Yellow	20
ACCESSORIES			
A194B	A194BP	194 replacement bulb	100
FMVSS	A P2 PC		
MATERIALS	Acrylic lens, ABS housing		
VOLT/AMP	12.8VDC - 0.2A		
WT/DIMS	.11 lb. / 3" x 2.25" x .938"		
WARRANTY	Three Year Warranty		



MC21/22 SERIES Beehive Marker/Clearance Lights

- Surface mount on 3/4" centers
- Single wire design grounds through mounting hardware
- Snap-on lens, replaceable bulb



BULK P/N	POLYPACK P/N	DESCRIPTION	QTY
YELLOW			
MC22AB	MC22ABP	Yellow	50
RED			
MC22RB	MC22RBP	Red	50
RETAIL			
MC21AS		Yellow light, clam	12
MC21RS		Red light, clam	12



FMVSS	P2 PC
MATERIALS	Acrylic lens, steel bracket
VOLT/AMP	12.8VDC - 0.4A
WT/DIMS	MC22: .176 lbs. / 2.563" x 2.563" x 3.688" MC21: .176 lbs. / 2.563" x 2.563" x 4.063"
WARRANTY	Three Year Warranty

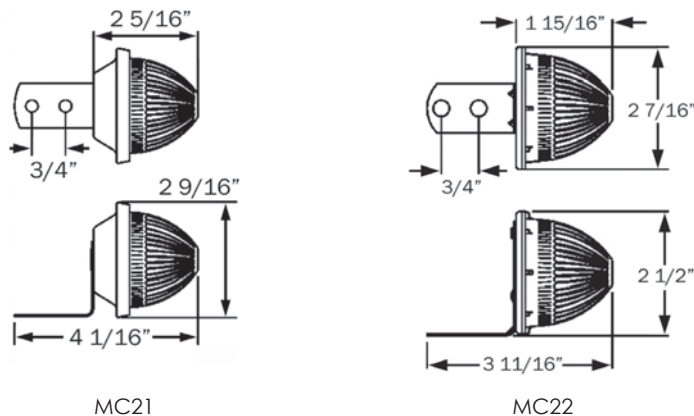

SURFACE MOUNT
MARKER/CLEARANCE LIGHTS



MC31/32 SERIES Surface Mount Marker/Clearance Lights with Reflex

- Surface mount on 3" centers
- Lens with reflex eliminates need for separate reflector
- MC31 is single wire design, grounds through mounting hardware
- MC32 has twist-in socket with separate ground wire
- Snap-on lens, replaceable 194 bulb



MC31AB



MC31RB

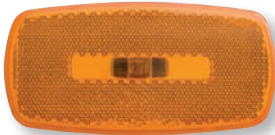
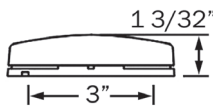
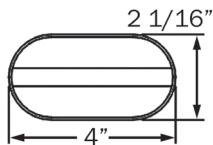



MC32AB

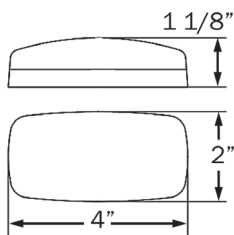

MC32RB



BULK P/N	POLYPACK P/N	DESCRIPTION	QTY
YELLOW			
MC31AB	MC31ABP	Oval, black base, single wire	100
MC31A15B2	-	MC31AB with .156 female barrels	100
MC32AB	MC32ABP	Oblong, white base, two-wire	100
MC32ABB	-	Oblong, black base, two-wire	100
RED			
MC31RB	MC31RBP	Oval, black base, single wire	100
MC31R15B2	-	MC31RB with .156 female barrels	100
MC32RB	MC32RBP	Oblong, white base, two-wire	100
MC32RBB	-	Oblong, black base, two-wire	100
ACCESSORIES			
A31AB	A31ABP	Yellow replacement lens, MC31	50
A31RB	A31RBP	Red replacement lens, MC31	50
A32AB	A32ABP	Yellow replacement lens, MC32	10
A32RB	A32RBP	Red replacement lens, MC32	50/10
A32GB	A32GBP	Mounting gasket, white	500
A194B	A194BP	194 replacement bulb	100
RETAIL			
MC31AS		MC31AB, clam	12
MC31RS		MC31RB, clam	12

FMVSS	A P2
MATERIALS	Acrylic lens, ABS housing
VOLT/AMP	12.8VDC - 0.2A
WT/DIMS	MC31: .088 lb. / 4" x 2.063" x 1.094" MC32: .11 lb. / 4" x 2" x 1.125"
WARRANTY	Three Year Warranty



A32GB

SURFACE MOUNT
MARKER/CLEARANCE LIGHTS

MC35/36 SERIES

Surface Mount Marker/Clearance Lights with Reflex

- Surface mount lights; choose from ear mount or stud mount versions
- Lens with reflex eliminates need for separate reflector
- MC35 is ear mount version
- MC36 is stud mount version
- Single wire design grounds through mounting hardware
- Screw-on lens, replaceable bulb, black plastic base

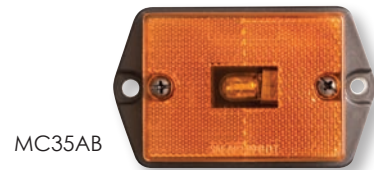

MC35AB



MC35RS



MC35AEB



MC36AB

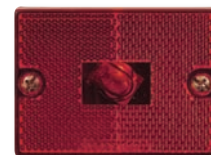

MC36RB

BULK P/N	POLYPACK P/N	DESCRIPTION	QTY
YELLOW			
MC35AB	MC35ABP	Yellow ear mount	50
MC35AEB	MC35AEBP	Yellow ear mount, rectangular	50
MC36AB	MC36ABP	Yellow stud mount	50
RED			
MC36RB	MC36RBP	Red stud mount	50
ACCESSORIES			
A36AB	A36ABP	Yellow replacement lens	50
A36RB	A36RBP	Red replacement lens	50
A194B	A194BP	194 replacement bulb	100
RETAIL			
MC35AS		Yellow ear mount light, clam	12
MC35RS		Red ear mount light, clam	12
MC36AS		Yellow stud mount light, clam	12
MC36RS		Red stud mount light, clam	12

FMVSS	A P2
MATERIALS	Acrylic lens, ABS housing
VOLT/AMP	12.8VDC - 0.2A
WT/DIMS	MC35: .132 lb. / 3.875" x 2.375" x 1.094" MC35AEB: .132 lb. / 3.75" x 2.063" x .938" MC36: .132 lb. / 2.75" x 2.125" x 1"
WARRANTY	Three Year Warranty

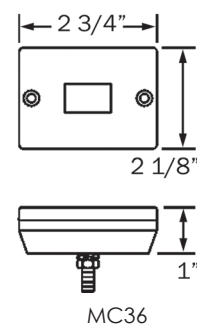
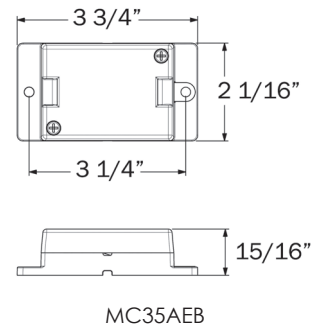
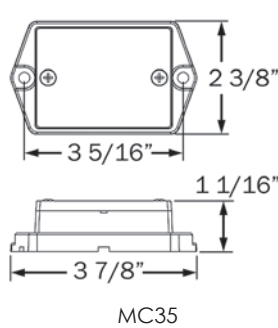

SURFACE MOUNT MARKER/CLEARANCE LIGHTS

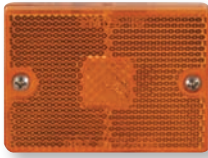

MC37AB

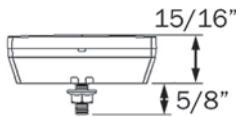
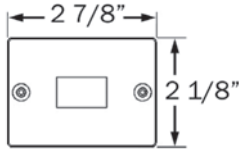

MC37 SERIES Stud Mount Marker/Clearance Light with Reflex

- Stud mount design; grounds through mounting stud
- Lens with reflex eliminates need for separate reflector
- Replaceable bulb
- Polycarbonate lens and housing

BULK P/N	POLYPACK P/N	DESCRIPTION	QTY
YELLOW			
MC37AB	MC37ABP	Yellow	50
ACCESSORIES			
A194B	A194BP	194 replacement bulb	100
FMVSS	A P2		
MATERIALS	Polycarbonate lens and housing		
VOLT/AMP	12.8VDC - 0.2A		
WT/DIMS	.11 lb. / 2.875" x 2.125" x .938"		
WARRANTY	Three Year Warranty		

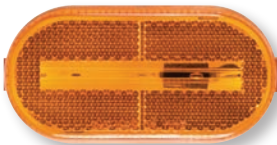

MC38AB

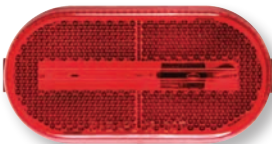

MC38RB

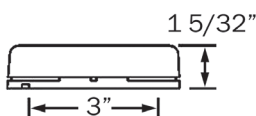
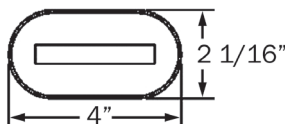

MC38 SERIES Surface Mount Marker/Clearance Lights with Reflex

- Surface mount on 3" centers
- Lens with reflex eliminates need for separate reflector
- Single wire design grounds through mounting hardware
- Snap-on lens, replaceable bulb

BULK P/N	POLYPACK P/N	DESCRIPTION	QTY
YELLOW			
MC38AB	MC38ABP	Yellow	50
RED			
MC38RB	MC38RBP	Red	50
ACCESSORIES			
A38AB	A38ABP	Yellow replacement lens	50
A38RB	A38RBP	Red replacement lens	50
A194B	A194BP	194 replacement bulb	100
FMVSS	A P2		
MATERIALS	Acrylic lens, ABS housing		
VOLT/AMP	12.8VDC - 0.2A		
WT/DIMS	.11 lb. / 4" x 2.063" x 1.156"		
WARRANTY	Three Year Warranty		

MC42 SERIES Dual Bulb Marker/Clearance Lights

- Dual bulb, bullseye style lights with black base
- Snap-on lens and replaceable bulbs
- Surface mount on 3" centers
- Single wire design grounds through mounting hardware

BULK P/N	POLYPACK P/N	DESCRIPTION	QTY
YELLOW			
MC42AB	MC42ABP	Yellow	50
RED			
MC42RB	MC42RBP	Red	50
ACCESSORIES			
A42AB	A42ABP	Yellow replacement lens	10
A42RB	A42RBP	Red replacement lens	10
A194B	A194BP	194 replacement bulb	100
RETAIL			
MC42AS		Yellow light, clam	12
MC42RS		Red light, clam	12
FMVSS	P2		
MATERIALS	Acrylic lens, ABS housing		
VOLT/AMP	12.8VDC - 0.4A		
WT/DIMS	.088 lb. / 4.094" x 2.125" x 1.125"		
WARRANTY	Three Year Warranty		



MC42AB



MC42RB

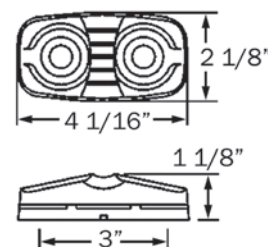

SURFACE MOUNT
MARKER/CLEARANCE LIGHTS

MC48 SERIES Marker/Clearance Lights with Reflex

- Flush mount on 3-3/8" centers
- Lens with reflex eliminates need for separate reflector
- Twist-in socket with replaceable bulb and ground wire

BULK P/N	POLYPACK P/N	DESCRIPTION	QTY
YELLOW			
MC48AB	MC48ABP	Yellow	50
MC48APG	-	Yellow with .156 female barrels	50
RED			
MC48RPG	-	Red with .156 female barrels	50
ACCESSORIES			
A194B	A194BP	194 replacement bulb	100
FMVSS	A P2		
MATERIALS	Acrylic lens, ABS housing		
VOLT/AMP	12.8VDC - 0.2A		
WT/DIMS	.132 lb. / 3.906" x 1.843" x 1.031"		
WARRANTY	Three Year Warranty		



MC48AB/APG



MC48RPG

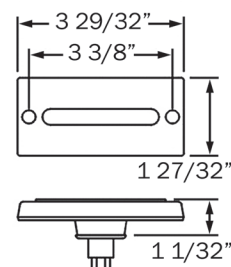



MC44 & BA44 SERIES Surface Mount Marker/Clearance Lights with Reflex

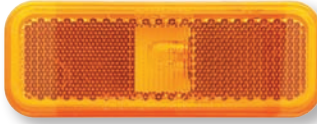

MC44AB



MC44RB



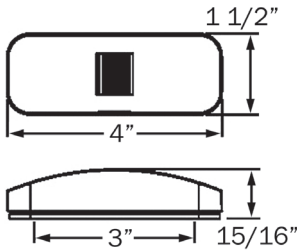

A44GB

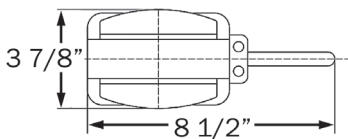

BA44FNL



- Surface mount on 3" centers
- Lens with reflex eliminates need for separate reflector
- Two-wire design includes both lead and ground wire
- Snap-on lens, replaceable bulb
- Fender light assembly includes one each MC44AB and MC44RB in black ABS bracket; female plug on power wire, grounding eyelet on ground wire

BULK P/N	POLYPACK P/N	DESCRIPTION	QTY
YELLOW			
MC44AB	MC44ABP	Yellow, two-wire	50
MC44AB1	MC44AB1P	Yellow, single wire	50
RED			
MC44RB	MC44RBP	Red, two-wire	50
MC44RB1	MC44RB1P	Red, single wire	50
YELLOW/RED FENDER LIGHT ASSEMBLY			
BA44FNL	BA44FNLP	Left side	25
BA44FNR	BA44FNRP	Right side	25
ACCESSORIES			
MC441WB	MC441WBP	Single wire base only	500
MC442WB	MC442WBP	Two-wire base only	50
A44A500B	-	Yellow replacement lens, 500-pack	500
A44R500B	-	Red replacement lens, 500-pack	500
A44AB	A44ABP	Yellow replacement lens	10
A44RB	A44RBP	Red replacement lens	10
A194B	A194BP	194 replacement bulb	100
A44GTB	-	Mounting gasket, thick, white	1000
RETAIL			
MC44AS		Yellow light, clam	12
MC44RS		Red light, clam	12



FMVSS	A P2
MATERIALS	Acrylic lens, ABS housing
VOLT/AMP	MC44: 12.8VDC - 0.4A BA44: 12.8VDC - 0.8A
WT/DIMS	MC44: .066 lb. / 4" x 1.5" x .938" BA44: .353 lb. / 8.5" x 3.875" x 1.75"
WARRANTY	Three Year Warranty

SURFACE MOUNT
MARKER/CLEARANCE LIGHTS

MC66 SERIES Surface Mount Dual Bulb Marker/Clearance Lights



- Surface mount on 3" centers
- Includes both lead and ground wires
- Snap-on lens, replaceable bulb

BULK P/N	POLYPACK P/N	DESCRIPTION	QTY
YELLOW			
MC66AB	MC66ABP	Yellow	50
MC66HAB	MC66HABP	Yellow, single wire, self grounding	50
RED			
MC66RB	MC66RBP	Red	50
ACCESSORIES			
A66AB	A66ABP	Yellow replacement lens	50
A66RB	A66RBP	Red replacement lens	50
A194B	A194BP	194 replacement bulb	100
RETAIL			
MC66AS		Yellow light, clam	12
MC66RS		Red light, clam	12
FMVSS	P2 PC		
MATERIALS	Acrylic lens, ABS housing		
VOLT/AMP	12.8VDC - 0.4A		
WT/DIMS	.132 lb. / 4" x 2.063" x 1.063"		
WARRANTY	Three Year Warranty		



MC66AB



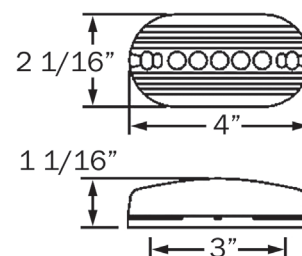

MC66RB



SURFACE MOUNT
MARKER/CLEARANCE LIGHTS

MC58 SERIES 2.5" Marker/Clearance Lights

- Surface mount on 1-1/2" centers
- Single wire design grounds through mounting hardware
- Snap-on lens, replaceable bulb

BULK P/N	POLYPACK P/N	DESCRIPTION	QTY
RETAIL			
MC58AS		Yellow light, clam	12
MC58RS		Red light, clam	12
ACCESSORIES			
A194B	A194BP	194 replacement bulb	100
FMVSS	P2		
MATERIALS	Acrylic lens, ABS housing		
VOLT/AMP	12.8VDC - 0.2A		
WT/DIMS	.066 lbs. / 2.5" x 2.5" x 1.063"		
WARRANTY	Three Year Warranty		



MC58RS



MC58AS

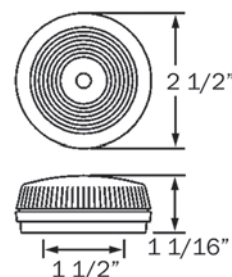



MC68 SERIES Oblong Marker/Clearance Lights

- Surface mount on 2-3/4" centers
- Single wire design grounds through mounting hardware
- Snap-on lens, replaceable bulb





MC68AB

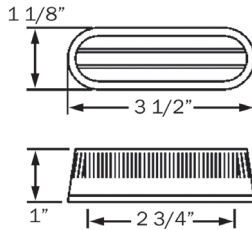

MC68RB



BULK P/N	POLYPACK P/N	DESCRIPTION	QTY
YELLOW			
MC68AB	MC68ABP	Yellow, self grounding	50
MC69AB	MC69ABP	Yellow, two-wire	100
RED			
MC68RB	MC68RBP	Red, self grounding	50
ACCESSORIES			
A68AB	A68ABP	Yellow replacement lens	10
A68RB	A68RBP	Red replacement lens	10
RETAIL			
MC68AS		Yellow light, clam	12
MC68RS		Red light, clam	12

FMVSS	P2
MATERIALS	Acrylic lens, ABS housing
VOLT/AMP	12.8VDC - 0.2A
WT/DIMS	.088 lb. / 3.5" x 1.125" x 1"
WARRANTY	Three Year Warranty



MC70 SERIES Marker/Clearance Lights with Reflex

- Surface mount on 4-13/16" centers
- Lens with reflex eliminates need for separate reflector
- Weathertight plug included



MC70AB



MC70RB

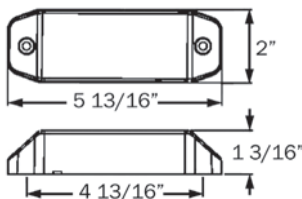

BULK P/N	POLYPACK P/N	DESCRIPTION	QTY
YELLOW			
MC70AB	MC70ABP	Yellow	20
RED			
MC70RB	MC70RBP	Red	20

FMVSS	A P2
MATERIALS	Acrylic lens, plastic housing
VOLT/AMP	12.8VDC - 0.422A
WT/DIMS	.132 lb. / 5.813" x 2" x 1.188"
WARRANTY	Three Year Warranty

MC71 SERIES Marker/Clearance Lights

- Flush mount on 2" centers; chrome finish bezel
- Twist-in socket, includes both lead and ground wire
- Replaceable bulb

BULK P/N	POLYPACK P/N	DESCRIPTION	QTY
RETAIL			
MC71AS		Yellow light, clam	12
MC71RS		Red light, clam	12
ACCESSORIES			
A194B	A194BP	194 replacement bulb	100

FMVSS	P2
MATERIALS	Acrylic lens, ABS housing and bezel
VOLT/AMP	12.8VDC - 0.4A
WT/DIMS	.132 lb. / 3.75" x 2.25" x 0.5"
WARRANTY	Three Year Warranty



MC71AS



MC71RS

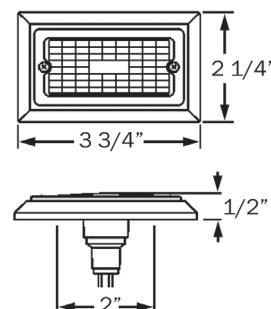

MC76 SERIES Marker/Clearance Light with Reflex

- Dual bulb light with built-in reflex
- Lens with reflex eliminates need for separate reflector
- Surface mount on 4-13/16" centers
- Hard wired, single wire design is self grounding

BULK P/N	POLYPACK P/N	DESCRIPTION	QTY
YELLOW			
MC76AB	MC76ABP	Yellow	50
ACCESSORIES			
A194B	A194BP	194 replacement bulb	100

FMVSS	A P2
MATERIALS	Acrylic lens, ABS housing
VOLT/AMP	12.8VDC - 1.0A
WT/DIMS	.132 lb. / 6" x 2.063" x 1"
WARRANTY	Three Year Warranty



MC76AB

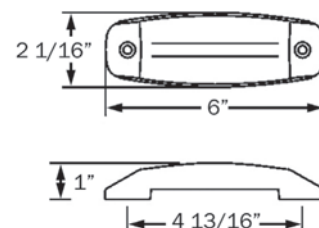

SURFACE MOUNT
MARKER/CLEARANCE LIGHTS



MC81AB



MC81RB

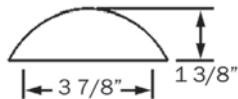
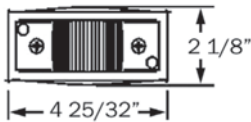

MC81 SERIES Chrome Marker/Clearance Lights

- Surface mount on 3-7/8" centers
- Single wire design grounds through mounting hardware
- Replaceable lens and bulb

BULK P/N	POLYPACK P/N	DESCRIPTION	QTY
YELLOW			
MC81AB	MC81ABP	Yellow, self grounding	50
RED			
MC81RB	MC81RBP	Red, self grounding	50
ACCESSORIES			
A81AB	A81ABP	Yellow replacement lens	50
A81RB	A81RBP	Red replacement lens	50
A194B	A194BP	194 replacement bulb	100
RETAIL			
MC81AS		Yellow light, clam	12
MC81RS		Red light, clam	12
FMVSS	P2		
MATERIALS	Acrylic lens, ABS housing		
VOLT/AMP	12.8VDC - 0.2A		
WT/DIMS	.176 lb. / 4.781" x 2.125" x 1.375"		
WARRANTY	Three Year Warranty		



MC82AB



MC82RB

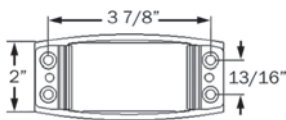

MC82 SERIES Armored Marker/Clearance Lights

- Surface mount on 3-7/8" centers
- Single wire design grounds through mounting hardware
- Replaceable lens and bulb



BULK P/N	POLYPACK P/N	DESCRIPTION	QTY
YELLOW			
MC82AB	MC82ABP	Yellow	20
RED			
MC82RB	MC82RBP	Red	20
ACCESSORIES			
A82AB	A82ABP	Yellow replacement lens	50
A82RB	A82RBP	Red replacement lens	50
A194B	A194BP	194 replacement bulb	100
FMVSS	P2 PC		
MATERIALS	Acrylic lens, painted steel housing		
VOLT/AMP	12.8VDC - 0.2A		
WT/DIMS	.441 lb. / 4.5" x 2" x 1.5"		
WARRANTY	Three Year Warranty		

MC85 SERIES Sealed Marker/Clearance Light

- Sonically sealed, waterproof
- Surface mount on 2-3/4" centers
- Hard wired, single wire design is self grounding

BULK P/N	POLYPACK P/N	DESCRIPTION	QTY
YELLOW			
MC85AB	MC85ABP	Yellow	50

FMVSS	P2 P3
MATERIALS	Polycarbonate lens and housing
VOLT/AMP	12.8VDC - 0.2A
WT/DIMS	.066 lb. / 3.188" x 1.063" x 1.063"
WARRANTY	Three Year Warranty



MC85AB

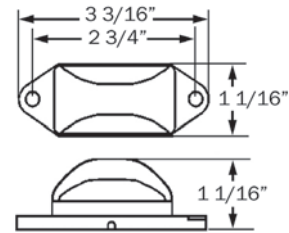

MC95 SERIES Sealed Marker/Clearance Lights

- Sonically sealed, waterproof
- Stainless steel base
- Single wire design grounds through mounting hardware

BULK P/N	POLYPACK P/N	DESCRIPTION	QTY
YELLOW			
MC95AB	MC95ABP	Yellow	50
MC95APG	-	Yellow, .180 male bullet	50

RED			
MC95RB	MC95RBP	Red	50
MC95RPG	-	Red, .180 male bullet	20

RETAIL			
MC95AS		Yellow light, clam	12
MC95RS		Red light, clam	12

FMVSS	P2 P3
MATERIALS	Polycarbonate lens and housing, stainless steel base
VOLT/AMP	12.8VDC - 0.2A
WT/DIMS	.088 lb. / 2.063" x .688" x 1"
WARRANTY	Three Year Warranty



MC95AB



MC95RB

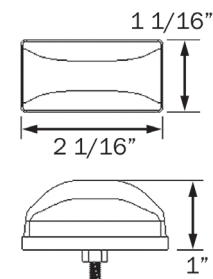

SURFACE MOUNT
MARKER/CLEARANCE LIGHTS



CB11WAB Yellow Cab/Clearance Light

- White base, mounts on 3" centers
- Replaceable lens and bulb (67 bulb)
- Includes both lead and ground wires



CB11WAB

BULK P/N	POLYPACK P/N	DESCRIPTION	QTY
CAB/CLEARANCE LIGHT			
CB11WAB	CB11WABP	Yellow, white base	50

FMVSS	P2 PC
MATERIALS	Acrylic lens, ABS housing
VOLT/AMP	12.8VDC - 0.569A
WT/DIMS	.265 lb. / 5.5" x 2.375" x 1.625"
WARRANTY	Three Year Warranty

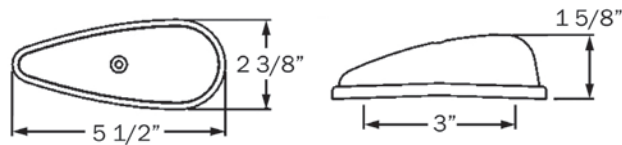

CB11AS/CB15AK Yellow Cab/Clearance Lights

- Black base, mounts on 3" centers
- Replaceable lens and bulb (67 bulb)
- Single wire design, self grounding



CB11AS



CB15AK

BULK P/N	POLYPACK P/N	DESCRIPTION	QTY
RETAIL			
CB11AS		Cab light, clam	12
CB15AK		5-pc cab light kit, clam	6

FMVSS	P2 PC
MATERIALS	Acrylic lens, ABS housing
VOLT/AMP	12.8VDC - 0.569A
WT/DIMS	CB11: .176 lb. / 5.5" x 2.375" x 1.625" CB15: 1.191 lbs. / 5.5" x 2.375" x 1.625"
WARRANTY	Three Year Warranty

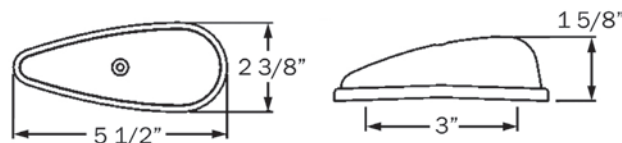

CB20AB Yellow Cab/Clearance Light

- Surface mount on 1-1/2" centers, gasket included
- Snap-on lens and replaceable bulb
- Includes both lead and ground wires



BULK P/N	POLYPACK P/N	DESCRIPTION	QTY
CAB/CLEARANCE LIGHT			
CB20AB	CB20ABP	Yellow	50
ACCESSORIES			
A194B	A194BP	194 replacement bulb	100
FMVSS	P2 PC		
MATERIALS	Acrylic lens, ABS housing		
VOLT/AMP	12.8VDC - 0.2A		
WT/DIMS	.265 lb. / 3.5" x 2.75" x 1.688"		
WARRANTY	Three Year Warranty		



CB20AB

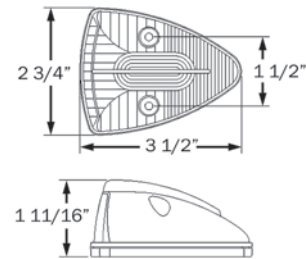

CB22 SERIES Cab/Clearance Lights



- Surface mount on 1-3/4" centers, gasket included
- Sealed polycarbonate lens and housing
- Twist-in socket with both lead and ground wires

BULK P/N	POLYPACK P/N	DESCRIPTION	QTY
YELLOW			
CB22AB	CB22ABP	Yellow	50
RED			
CB22RB	CB22RBP	Red	50
ACCESSORIES			
A194B	A194BP	194 replacement bulb	100
FMVSS	P2 PC		
MATERIALS	Polycarbonate lens and housing		
VOLT/AMP	12.8VDC - 0.2A		
WT/DIMS	.132 lb. / 3.875" x 3.125" x 1.625"		
WARRANTY	Three Year Warranty		



CB22AB



CB22RB

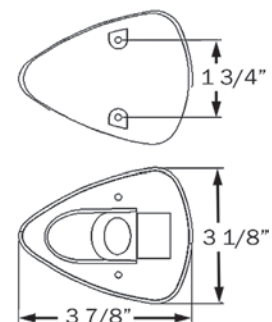



MC77RB Identification Light Bar



MC77RB

- Steel base with white finish
- Surface mount on 7" centers
- Snap-on lens and replaceable bulb
- Single wire design, self grounding

BULK P/N	POLYPACK P/N	DESCRIPTION	QTY
RED ID LIGHT BAR			
MC77RB	MC77RBP	ID light bar	20

ACCESSORIES

A68RB	A68RBP	Red replacement lens	10
-------	--------	----------------------	----

FMVSS	P2		
MATERIALS	Acrylic lens, ABS housing, steel base		
VOLT/AMP	12.8VDC - 1.0A (193 bulb)		
WT/DIMS	.265 lb. / 15.563" x 1.188" x 1.313"		
WARRANTY	Three Year Warranty		

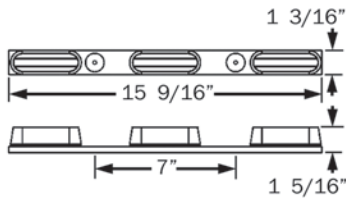

IDENTIFICATION LIGHT BARS



MC93 SERIES Sealed Identification Light Bars

MC93AB

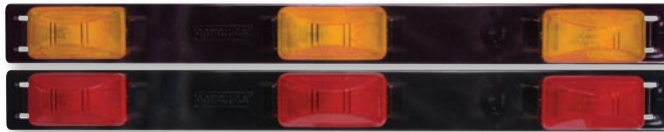

MC93RB

- Surface mount on 7-1/2" centers
- Sealed, waterproof lights
- Hard wired, power and ground

BULK P/N	POLYPACK P/N	DESCRIPTION	QTY
YELLOW			
MC93AB	MC93ABP	Yellow	20

RED

MC93RB	MC93RBP	Red	20
MC93RPG	MC93RPGP	Red, .180 male bullet on power wire	20
MC93R2PG	MC93R2PGP	Red, .180 male bullets on both wires	20

ACCESSORIES

A91AB	A91ABP	Yellow replacement light	100
A91RB	A91RBP	Red replacement light	100
A93PB	A93PBP	Harness for light bar	100

RETAIL

MC93RK		Red ID light bar, clam	6
--------	--	------------------------	---

FMVSS	P2		
MATERIALS	Polycarbonate lens and housing, ABS base		
VOLT/AMP	12.8VDC - 1.0A		
WT/DIMS	.397 lb. / 17" x 1.438" x 1.625"		
WARRANTY	Three Year Warranty		

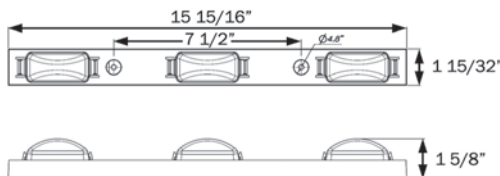



MC94RB Identification Light Bar

- Stainless steel base
- Surface mount on 16-1/16" centers
- Sealed, waterproof lights
- Hard wired, power and ground



MC94RB

BULK P/N	POLYPACK P/N	DESCRIPTION	QTY
RED ID LIGHT BAR			
MC94RB	MC94RBP	ID light bar	20
ACCESSORIES			
A91RB	A91RBP	Red replacement light	100
A93PB	A93PBP	Harness for light bar	100
FMVSS	P2		
MATERIALS	Polycarbonate lens and housing, stainless steel base		
VOLT/AMP	12.8VDC - 1.0A		
WT/DIMS	.441 lb. / 16.5" x 1.375" x 1.625"		
WARRANTY	Three Year Warranty		

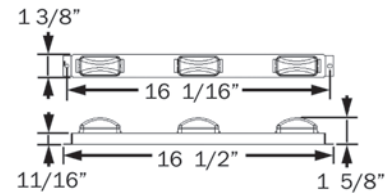

MC97 SERIES Sealed Identification Light Bars

- Stainless steel base
- Surface mount on 8-1/2" centers
- Sealed, waterproof lights
- Single wire, self grounding



MC97RB

BULK P/N	POLYPACK P/N	DESCRIPTION	QTY
RED ID LIGHT BARS			
MC97RB	MC97RBP	Red	20
MC97RPG	MC97RPGP	Red, .180 male bullet	20
MC97R70PG	-	Red, .156 female plug, 70" lead	20
MC97RTTG	-	Red, .180 female plug	50
CLEAR UTILITY LIGHT			
UL97CPG	UL97CPGP	Clear	50
ACCESSORIES			
MC95RB	MC95RBP	Red replacement light	50
RETAIL			
MC97RK		Red ID light bar, clam	6
FMVSS	P2		
MATERIALS	Polycarbonate lens and housing, stainless steel base		
VOLT/AMP	12.8VDC - 1.0A		
WT/DIMS	.441 lb. / 14.25" x 1.188" x 1.313"		
WARRANTY	Three Year Warranty		

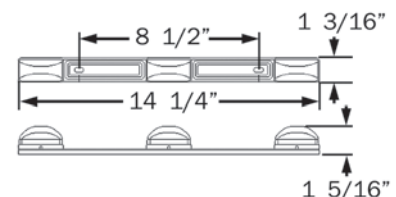

IDENTIFICATION LIGHT BARS





MC99 SERIES Identification Light Bars

MC99AB



MC99RB

- Steel base with white finish
- Surface mount on 14-3/8" centers
- Snap-on lens, replaceable bulbs
- Single wire, self grounding

BULK P/N	POLYPACK P/N	DESCRIPTION	QTY
YELLOW			
MC99AB	MC99ABP	Yellow	20
RED			
MC99RB	MC99RBP	Red	20
ACCESSORIES			
A11AB	A11ABP	Yellow replacement lens	50
A11RB	A11RBP	Red replacement lens	50
A194B	A194BP	194 replacement bulb	100
RETAIL			
MC99AK		Yellow ID light bar, clam	6
MC99RK		Red ID light bar, clam	6

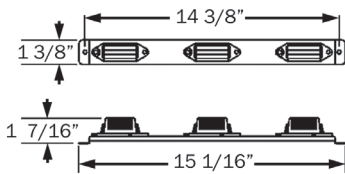

FMVSS	P2
MATERIALS	Acrylic lens, ABS housing, steel base
VOLT/AMP	12.8VDC - 1.0A
WT/DIMS	.353 lb. / 15.063" x 1.375" x 1.438"
WARRANTY	Three Year Warranty

IDENTIFICATION LIGHT BARS





RB10 SERIES Magnet Mount Rotary Beacons

- 12V rotary beacons for magnet mount
- 10-ft coil cord with power plug
- Replaceable bulb



RB10A

RB10R

BULK P/N	DESCRIPTION	QTY
RETAIL		
RB10A	Yellow rotary beacon, clam 	6
RB10R	Red rotary beacon, clam 	6
MATERIALS	Acrylic lens	
VOLT/AMP	12.8VDC - 1.45A	
WT/DIMS	.176 lb. / 4.75" x 4.75" x 5.25"	
WARRANTY	Three Year Warranty	

LP11 SERIES Snap-In Mini License Plate Lights

- Chrome plated brass construction
- Easy snap-in mounting
- Replaceable bulb (67)
- Single wire, self grounding

BULK P/N	POLYPACK P/N	DESCRIPTION	QTY
LICENSE LIGHTS			
LP11CB	LP11CBP	License light	50
LP11CPG	LP11CPGP	License light, .180 male bullet	50
RETAIL			
LP11CS		License light, clam	12

FMVSS	(2) L
MATERIALS	Brass, chrome plated
VOLT/AMP	12.8VDC - 0.4A
WT/DIMS	.066 lb. / 1.5" x 1.5" x 2"
WARRANTY	Three Year Warranty



LP11CB

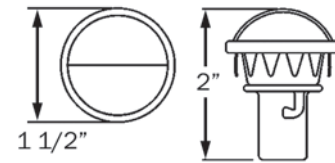

LP21 SERIES Heavy Duty License Plate Lights

- Armored light made of durable chrome plated steel
- Surface mount on 2" centers
- Replaceable bulb (67)
- Single wire, self grounding

BULK P/N	POLYPACK P/N	DESCRIPTION	QTY
LICENSE LIGHTS			
LP21CB	LP21CBP	License light	50
RETAIL			
LP21CS		License light, clam	12

FMVSS	L
MATERIALS	Brass, chrome plated
VOLT/AMP	12.8VDC - 0.2A
WT/DIMS	.132 lb. / 2.5" x 1.813" x 2"
WARRANTY	Three Year Warranty



LP21CB

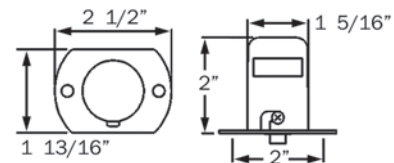



LP31 SERIES Mini License Plate Light



LP31CB

- Surface mount on 2" centers
- Replaceable bulb
- Two-wire design includes both lead and ground wire



LPB31CPG

BULK P/N	POLYPACK P/N	DESCRIPTION	QTY
LICENSE LIGHTS			
LP31CB	LP31CBP	License light	50
LP31CPG	LP31CPGP	License light, .156 female barrels	50
LPB31CPG	LPB31CPGP	License light mounted on black plastic bracket, .156 female barrels	25
ACCESSORIES			
A194B	A194BP	194 replacement bulb	100
RETAIL			
LP31CS		License light, clam	12

FMVSS	(2) L
MATERIALS	Brass, chrome plated bezel; stainless steel bulb socket
VOLT/AMP	12.8VDC - 0.261A
WT/DIMS	.088 lb. / 2.563" x 1.25" x 1" (light only)
WARRANTY	Three Year Warranty

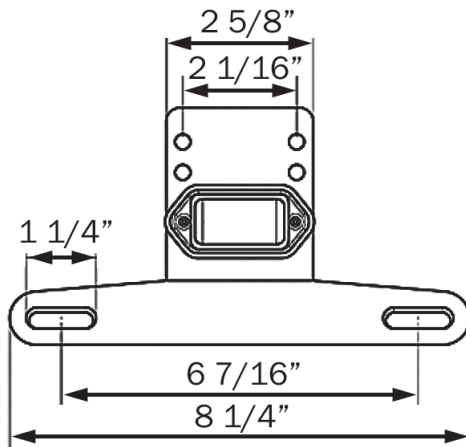

LPB31CPG

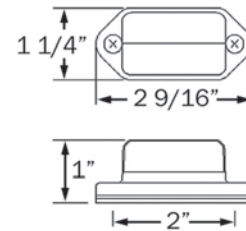
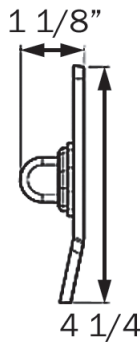

LP31CB

LP41 SERIES Stud Mount License Plate Light

- Chrome plated cover, black base
- Stud mount on 1-3/4" centers
- Replaceable bulb
- Single wire, self grounding

BULK P/N	POLYPACK P/N	DESCRIPTION	QTY
LICENSE LIGHTS			
LP41CB	LP41CBP	License light	50
ACCESSORIES			
A194B	A194BP	194 replacement bulb	100
RETAIL			
LP41CS		License light, clam	12

FMVSS	L
MATERIALS	Brass, chrome plated
VOLT/AMP	12.8VDC - 0.2A
WT/DIMS	.11 lb. / 2.625" x 1.563" x 2.188"
WARRANTY	Three Year Warranty



LP41CB

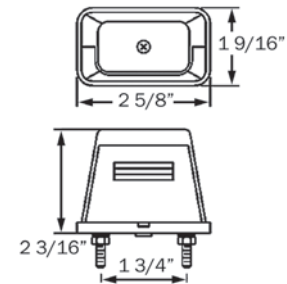

LP51 SERIES Surface Mount License Plate Light

- Gray coated cover, stainless steel mounting base
- Stud mount on 3-1/4" centers
- Replaceable bulb
- Single wire, self grounding

BULK P/N	POLYPACK P/N	DESCRIPTION	QTY
LICENSE LIGHTS			
LP51CB	LP51CBP	License light	20
ACCESSORIES			
A194B	A194BP	194 replacement bulb	100

FMVSS	L
MATERIALS	Stainless steel mounting base, plastic cover
VOLT/AMP	12.8VDC - 0.2A
WT/DIMS	.309 lb. / 4" x 1.75" x 2.313"
WARRANTY	Three Year Warranty



LP51CB

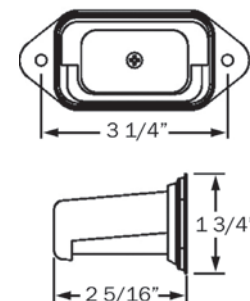



LP52/54 SERIES License Plate Light with Bracket

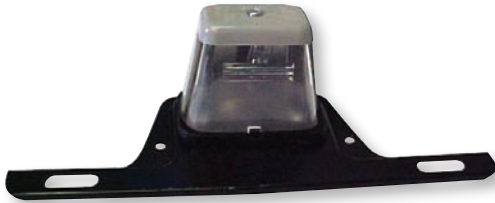

LP52CB

- Light features gray coated cover, stainless steel mounting base; bracket is steel with black finish
- Surface mount on 3.5" centers, hardware included
- Replaceable bulb

BULK P/N	POLYPACK P/N	DESCRIPTION	QTY
LICENSE LIGHTS			
LP52CB	LP52CBP	License light, single wire	10
LP54CB	LP54CBP	License light, two-wire	10
ACCESSORIES			
LP52HP	LP52HPP	Mounting hardware	100
A194B	A194BP	194 replacement bulb	100

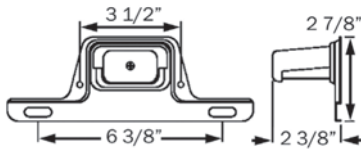

FMVSS	L
MATERIALS	Stainless steel mounting base, plastic cover, steel bracket
VOLT/AMP	12.8VDC - 0.2A
WT/DIMS	.309 lb. / 8.5" x 2.875" x 2.375"
WARRANTY	Three Year Warranty

LICENSE/UTILITY LIGHTS



LP55 SERIES License Plate Light with Bracket



LP55CB

- Light features gray coated cover, stainless steel mounting base; bracket is black heavy duty plastic
- Surface mount on 6-7/16" centers
- Includes both lead and ground wires
- Replaceable bulb (67)

BULK P/N	POLYPACK P/N	DESCRIPTION	QTY
LICENSE LIGHTS			
LP55CB	LP55CBP	License light	10

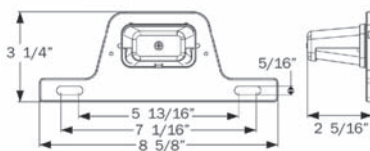

FMVSS	L
MATERIALS	Stainless steel mounting base, plastic cover, steel bracket
VOLT/AMP	12.8VDC - 0.2A
WT/DIMS	.176 lb. / 8.625" x 3.25" x 2.313"
WARRANTY	Three Year Warranty

LP56 SERIES

Surface Mount License Plate Light

- Surface mount with included adhesive
- Replaceable bulb (67)
- Single wire, self grounding

BULK P/N	POLYPACK P/N	DESCRIPTION	QTY
LICENSE LIGHTS			
LP56CB	LP56CBP	License light	50

FMVSS	L
MATERIALS	Gray plastic housing
VOLT/AMP	12.8VDC - 0.2A
WT/DIMS	.11 lb. / 2.625" x 1.625" x 2"
WARRANTY	Three Year Warranty



LP56CB

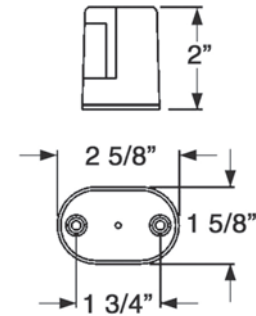

LP65 SERIES

Sealed License Plate Light

- Sonically sealed, waterproof
- Multiple mounting and wiring options

BULK P/N	POLYPACK P/N	DESCRIPTION	QTY
LICENSE LIGHTS			
LP65CB	LP65CBP	License light	50

ACCESSORIES			
A65B	A65BP	Black bracket	50
A65P	A65PP	Single wire plug, .156 male bullet	50
A65PB	A65BPP	Kit: A65B black bracket & A65P plug	50
A66PB	A66BPP	Kit: Gray bracket & A65P plug	50
A67CB	A67CBP	Kit: Chrome bracket & A65P plug	50
A68PB	A68BPP	Kit: Black bracket & 2-wire plug	50

For more details on mounting and wiring accessories, see Accessories section at back of catalog.

FMVSS	L
MATERIALS	Polycarbonate lens and housing
VOLT/AMP	12.8VDC - 0.656A
WT/DIMS	.066 lb. / 3.938" x 1.25" x 0.875"
WARRANTY	Three Year Warranty



LP65CB

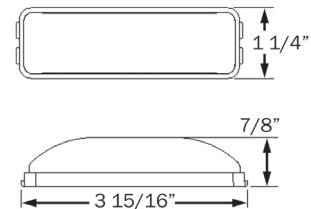



LP71 SERIES Chrome License Plate Light



LP71CB

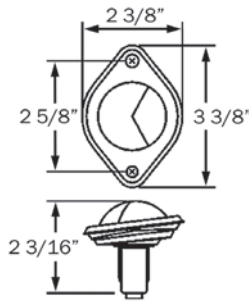

- Chrome-plated brass and steel housing
- Mount on 2-5/8" centers
- Replaceable bulb (67)
- Single wire, self grounding
- Two units required for legal license illumination

BULK P/N	POLYPACK P/N	DESCRIPTION	QTY
LICENSE LIGHTS			
LP71CB	LP71CBP	License light	25

FMVSS	(2) L
MATERIALS	Brass and stainless steel housing
VOLT/AMP	12.8VDC - 0.2A
WT/DIMS	.058 lb. / 3.375" x 2.375" x 2.188"
WARRANTY	Three Year Warranty

LICENSE/UTILITY LIGHTS



LP81 SERIES Surface Mount License Plate Light



LP81BB

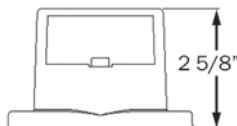
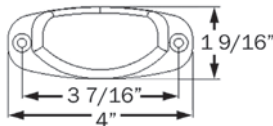

- Surface mount on 3-7/16" centers
- Replaceable bulb
- Includes both lead and ground wires

BULK P/N	POLYPACK P/N	DESCRIPTION	QTY
LICENSE LIGHTS			
LP81BB	LP81BBP	License light	50
LP81BPG	-	License light, .180 male plug on power, ground eyelet on ground	50

ACCESSORIES			
A194B	A194BP	194 replacement bulb	100

FMVSS	L
MATERIALS	Polycarbonate housing
VOLT/AMP	12.8VDC - 0.2A
WT/DIMS	.11 lb. / 4" x 1.563" x 2.625"
WARRANTY	Three Year Warranty

LP97 SERIES Sealed License/Utility Light

- Sonically sealed, waterproof
- Terminal is two .156 female barrels

BULK P/N	POLYPACK P/N	DESCRIPTION	QTY
LICENSE LIGHTS			
LP97CB	LP97CBP	License light	50

FMVSS	L
MATERIALS	Polycarbonate lens and housing
VOLT/AMP	12.8VDC - 0.2A
WT/DIMS	.11 lb. / 3.375" x 1.25" x 2.375"
WARRANTY	Three Year Warranty



LP97CB

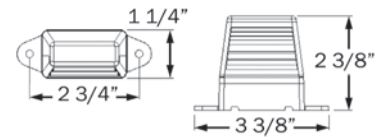

LP95CBF Sealed Stud Mount License/Utility Light

- Sonically sealed, waterproof
- Design includes both lead and ground wires with .180 female barrels

BULK P/N	POLYPACK P/N	DESCRIPTION	QTY
LICENSE/UTILITY LIGHTS			
LP95CBF	-	License/utility light	50

MATERIALS	Polycarbonate lens and housing, stainless steel base
VOLT/AMP	12.8VDC - 0.2A
WT/DIMS	.066 lb. / 2.063" x .688" x 1"
WARRANTY	Three Year Warranty



LP95CBF

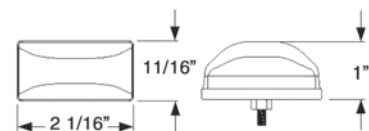



LP85 SERIES Sealed License/Utility Light



LP85CB

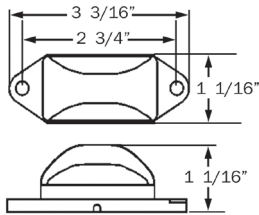

- Sonically sealed, waterproof
- Single wire design grounds through mounting hardware

BULK P/N	POLYPACK P/N	DESCRIPTION	QTY
LICENSE/UTILITY LIGHTS			
LP85CB	LP85CBP	License/utility light	50
LP85CEZB	LP85CEZBP	License/utility light, .180 male bullet	50
MATERIALS	Polycarbonate lens and housing		
VOLT/AMP	12.8VDC - 0.2A		
WT/DIMS	.066 lb. / 3.188" x 1.063" x 1.063"		
WARRANTY	Three Year Warranty		



LP91 SERIES Sealed License/Utility Light



LP91CB

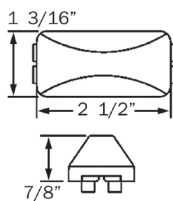

- Sonically sealed, waterproof
- Multiple mounting and wiring options

BULK P/N	POLYPACK P/N	DESCRIPTION	QTY
LICENSE/UTILITY LIGHTS			
LP91CB	LP91CBP	License/utility light	50
LP26SKB	LP26SKBP	Kit: LP91CB, LP25SGGB, gasket, .180 male bullets on power and ground	50
LICENSE LIGHT BRACKET			
LP25SB	LP25SBP	Vertical bracket, black coated	100
LP25SGGB	LP25SGGBP	Vertical bracket, gray coated	100
ACCESSORIES			
A46PB	A46PBP	2-wire plug, 6" lead	100
A86PB	A86PBP	2-wire plug, 18" lead	100
A91LW	A91LWP	1-wire plug, 12" lead	100
A91BB	A91BBP	Black base, self grounding	100
A91BOB	A91BOBP	Black base, open back	100
A91CB	A91CBP	Chrome base, self grounding	100
A91OB	A91OBP	Chrome base, open back	100
A91GB	A91GBP	Grommet	100
A82BB	A82BBP	Black base, open back (use with A90CB)	50
A90CB	A90CBP	Chrome cover for A82BB	50
MATERIALS	Polycarbonate lens and housing		
VOLT/AMP	12.8VDC - 0.2A		
WT/DIMS	.066 lb. / 2.5" x 1.1885" x 0.875"		
WARRANTY	Three Year Warranty		



LP26SKB

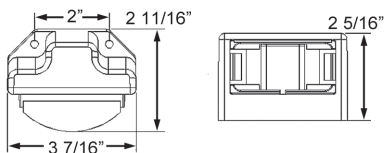

UL94 SERIES Sealed Stud Mount License/Utility Light

- Sonically sealed, waterproof
- Polycarbonate housing, stainless steel base, clear lens
- Single wire design grounds through mounting hardware

BULK P/N	POLYPACK P/N	DESCRIPTION	QTY
LICENSE/UTILITY LIGHT			
UL94CB	UL94CBP	License/utility light	50

MATERIALS	Polycarbonate lens and housing, stainless steel base
VOLT/AMP	12.8VDC - 0.2A
WT/DIMS	.088 lb. / 2.125" x 1.125" x 1.063"
WARRANTY	Three Year Warranty



UL94CB

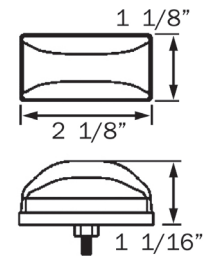

UL95 SERIES Sealed Launch/Load Light

- Sonically sealed, waterproof
- Polycarbonate lens and housing
- Accepts standard two-pin PL-10 connector
- Multiple mounting and wiring options available

BULK P/N	POLYPACK P/N	DESCRIPTION	QTY
LAUNCH/LOAD LIGHT			
UL95CB	UL95CBP	Launch/load light	100

ACCESSORIES			
A46PB	A46PBP	2-wire plug, 6" lead	100
A86PB	A86PBP	2-wire plug, 18" lead	100
A91LW	A91LWP	1-wire plug, 12" lead	100
A91BB	A91BBP	Black base, self grounding	100
A91BOB	A91BOBP	Black base, open back	100
A91CB	A91CBP	Chrome base, self grounding	100
A91OB	A91OBP	Chrome base, open back	100
A91GB	A91GBP	Grommet	100
A82BB	A82BBP	Black base, open back (use with A90CB)	50
A90CB	A90CBP	Chrome cover for A82BB	50

MATERIALS	Polycarbonate lens and housing
VOLT/AMP	12.8VDC - 0.4A
WT/DIMS	.066 lb. / 2.625" x 1.25" x 1.188"
WARRANTY	Three Year Warranty



UL95CB

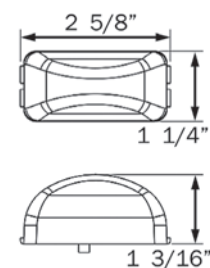



UL97 SERIES Sealed Utility Light Bar



UL97CPG

- Sonically sealed, waterproof
- Polycarbonate lens and housing, stainless steel base
- Single wire design grounds through mounting hardware
- Plug-n-go connector

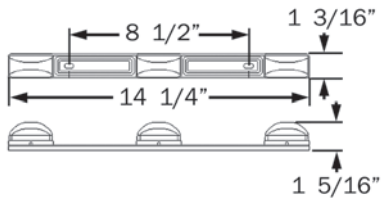

BULK P/N	POLYPACK P/N	DESCRIPTION	QTY
UTILITY LIGHT			
UL97CPG	UL97CPGP	Utility light bar	50

MATERIALS	Polycarbonate lens and housing, stainless steel base
VOLT/AMP	12.8VDC - 0.4A
WT/DIMS	.265 lb. / 14.25" x 1.188" x 1.313"
WARRANTY	Three Year Warranty

LICENSE/UTILITY LIGHTS



UL71 SERIES Courtesy/Utility Light



UL71CS

- Chrome-plated ABS housing
- Twist-in bulb socket with lead and ground wires
- Replaceable bulb

BULK P/N	POLYPACK P/N	DESCRIPTION	QTY
RETAIL			
UL71CS		Utility light, clam	12
ACCESSORIES			
A194B	A194BP	194 replacement bulb	100

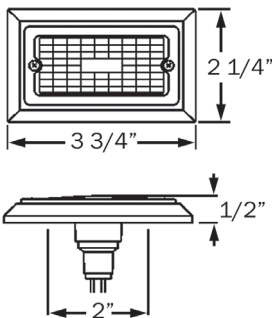

MATERIALS	Acrylic lens, ABS housing
VOLT/AMP	12.8VDC - 0.4A
WT/DIMS	.176 lb. / 3.75" x 2.25" x .5"
WARRANTY	Three Year Warranty

UL53 SERIES 2" Sealed Utility Light

- Sonically sealed, waterproof
- Accepts standard two-pin PL-10 plug

BULK P/N	POLYPACK P/N	DESCRIPTION	QTY
UTILITY LIGHT			
UL53CB	UL53CBP	Utility light	100/50
ACCESSORIES			
A46PB	A46PBP	Straight plug, 6" lead	100
A86PB	A86PBP	Straight plug, 18" lead	100
A54GB	A54GBP	2" Flush mount grommet	100
A54GK	A54GKP	2" Kit: A54GB and A46PB	100
A55CB	A55CBP	2" Chrome trim ring	20
BK5557GB	BK5557GBP	Cam-on mounting bracket	50

MATERIALS	Polycarbonate lens and housing
VOLT/AMP	12.8VDC - 0.6A
WT/DIMS	.044 lb. / 2" x 2" x .688"
WARRANTY	Three Year Warranty



UL53CB

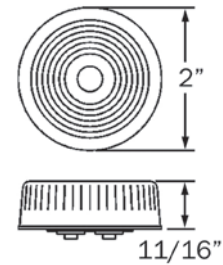

UL56 SERIES 2.5" Sealed Utility Light

- Sonically sealed, waterproof
- Accepts standard two-pin PL-10 plug
- Flush mount design with flange sealed to light

BULK P/N	POLYPACK P/N	DESCRIPTION	QTY
UTILITY LIGHT			
UL56CB	UL56CBP	Utility light	100/50
ACCESSORIES			
A46PB	A46PBP	Straight plug, 6" lead	100
A86PB	A86PBP	Straight plug, 18" lead	100

MATERIALS	Polycarbonate lens and housing
VOLT/AMP	12.8VDC - 0.6A
WT/DIMS	.044 lb. / 2" x 2" x .688"
WARRANTY	Three Year Warranty



UL56CB

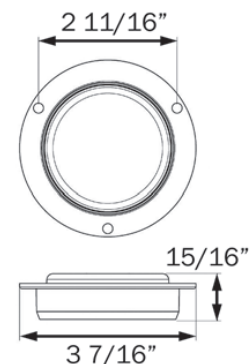



IL11CS Mini Interior Light



IL11CS

- Mini interior light with on/off switch
- Surface mount with included adhesive tape
- Includes both lead and ground wire
- Replaceable bulb

BULK P/N	POLYPACK P/N	DESCRIPTION	QTY
RETAIL			
IL11CS		Interior light, clam	12

MATERIALS	Acrylic lens, ABS housing
VOLT/AMP	12.8VDC - 0.4A
WT/DIMS	.15 lb. / 3.25" x 1.25" x 1"
WARRANTY	Three Year Warranty

UTILITY/INTERIOR LIGHTS



IL21 SERIES Interior Dome Light



IL21CB

- Surface mount dome light with or without on/off switch
- Mounts on 3-1/2" centers
- Includes both lead and ground wire
- Replaceable bulb (1156)

BULK P/N	POLYPACK P/N	DESCRIPTION	QTY
INTERIOR LIGHTS			
IL21CB	IL21CBP	Interior light with switch, two-wire	50
IL21CPG	-	Interior light with switch, single wire with .180 male bullet	50
IL22CB	IL22CBP	Interior light without switch, two-wire	50
RETAIL			
IL21CS		Interior dome light with switch, clam	12

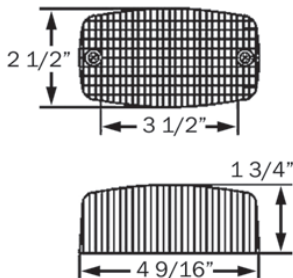

MATERIALS	Polycarbonate lens, steel base plate
VOLT/AMP	12.8VDC - 2.4A
WT/DIMS	.309 lb. / 4.563" x 2.5" x 1.75"
WARRANTY	Three Year Warranty

IL31CS Porch or Cabin Light

- Surface mount light with on/off switch
- Aluminum base, durable plastic lens
- Single wire design grounds through mounting hardware
- Replaceable bulb (1156)

BULK P/N	POLYPACK P/N	DESCRIPTION	QTY
RETAIL			
IL31CS		Porch/cabin light, clam	6

MATERIALS	Plastic lens, aluminum housing
VOLT/AMP	12.8VDC - 2.2A
WT/DIMS	.375 lb. / 5.125" x 5.125" x 1.813"
WARRANTY	Three Year Warranty



IL31CS

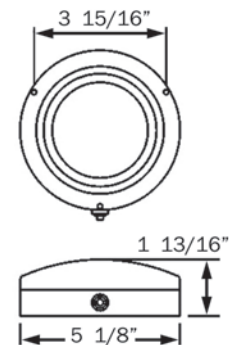

IL41 SERIES 4" Interior/Exterior Utility Light

- Flange mount light with steel housing and acrylic lens
- Includes both lead and ground wires
- Replaceable bulb (1142)

BULK P/N	POLYPACK P/N	DESCRIPTION	QTY
INTERIOR/EXTERIOR LIGHT			
IL41CB	IL41CBP	Interior light with switch, two-wire	50

MATERIALS	Acrylic lens, steel housing
VOLT/AMP	12.8VDC - 1.5A
WT/DIMS	.441 lb. / 6.438" x 6.438" x 1.75"
WARRANTY	Three Year Warranty



IL41CB

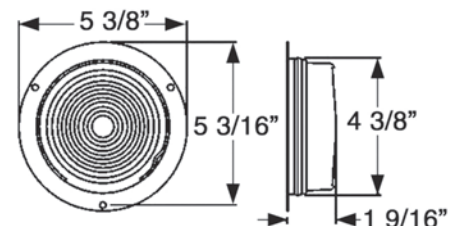



IL61 SERIES Dome Light with Switch



IL61CB

- Surface mount light with on/off switch
- Aluminum base, durable plastic lens
- Single wire design grounds through mounting hardware
- Replaceable bulb (1141)

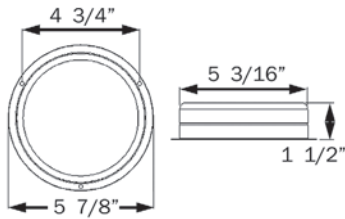

BULK P/N	POLYPACK P/N	DESCRIPTION	QTY
DOME LIGHT			
IL61CB	IL61CBP	Dome light	50

MATERIALS	Plastic lens, aluminum housing
VOLT/AMP	12.8VDC - 0.4A
WT/DIMS	.221 lb. / 5.875" x 5.875" x 1.5"
WARRANTY	Three Year Warranty

UTILITY/INTERIOR LIGHTS



IL91 SERIES 6" Steel Dome Light



IL91CB

- Surface mount steel base, chrome plated
- Includes both lead and ground wires
- Replaceable bulb (1141)

BULK P/N	POLYPACK P/N	DESCRIPTION	QTY
DOME LIGHT			
IL91CB	IL91CBP	Dome light	50

MATERIALS	Polycarbonate lens, steel housing
VOLT/AMP	12.8VDC - 0.4A
WT/DIMS	.485 lb. / 6.438" x 6.438" x 1.75"
WARRANTY	Three Year Warranty

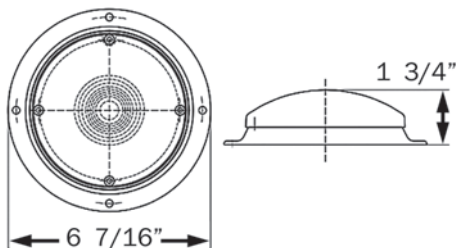

TL10 SERIES 5" Work Lights, Rubber Housings

- Utility/work/ag light with shock proof rubber housing
- #4411 sealed beam
- Include both lead and ground wires
- Steel bracket, 5/16" mounting post

BULK P/N	POLYPACK P/N	DESCRIPTION	QTY
WORK/UTILITY/AG LIGHTS			
TL10CB	TL10CBP	12V, 2-wire	25
TL10C24VB	-	24V, 2-wire	25
TL10CPG	-	12V, 2-wire, .180 male bullets	25
TL11CPG	-	12V, self grounding, .180 male bullet	25
RETAIL			
TL10CS	12V Work/utility/ag light, clam		6
TL106CS	6V Work/utility/ag light, clam		6
TL10SS	12V Work/utility/ag light, stainless steel bracket, clam		6
TL12CS	12V Work/utility/ag light, recessed bulb, clam		6
MATERIALS	Rubber housing, glass lens, steel bracket		
VOLT/AMP	12.8VDC - 2.8A		
WT/DIMS	1.235 lbs. / 4.75" x 4.75" x 2.5"		
WARRANTY	Three Year Warranty		



TL10CB

TL35/46 SERIES 55W Rectangular Utility/Ag Lights

- Utility/ag light with heavy duty plastic housing
- 12V 55W H3 halogen bulb
- Include both lead and ground wires
- Adjustable, steel mounting bracket

BULK P/N	POLYPACK P/N	DESCRIPTION	QTY
UTILITY/AG LIGHTS			
TL35TB	-	3" x 5" lens, trapezoid beam	20
RETAIL			
TL35FS	3" x 5" lens, flood beam, clam		3
TL35TS	3" x 5" lens, trapezoid beam, clam		3
TL46FS	4" x 6" lens, flood beam, clam		3
TL46TS	4" x 6" lens, trapezoid beam, clam		3
A700	12V 55W H3 quartz halogen bulb, clam		12
MATERIALS	Plastic housing, glass lens, steel bracket		
VOLT/AMP	12.8VDC - 4.5A		
WT/DIMS	TL35: 1.5 lbs. / 6.5" x 4.375" x 3.75" TL46: 1.5 lbs. / 5.375" x 4.5" x 2.25"		
WARRANTY	Three Year Warranty		



TL35FS/TS



TL46FS/TS



DL16 SERIES 55W Docking Lights



DL16CB

- Docking light with heavy duty plastic housing, glass lens
- 12V 55W H3 halogen bulb
- Includes both lead and ground wires with male bullets
- Stainless steel mounting bracket with rubber cover



DL16WC

BULK P/N	POLYPACK P/N	DESCRIPTION	QTY
DOCKING LIGHTS			
DL16CB	-	Black housing	50
RETAIL			
DL16CC	Kit: (2) DL16CB, wiring, mounting hardware & switch, clam		3
DL16WC	Kit: (2) DL16WB, wiring, mounting hardware & switch, clam		3
A700	12V 55W H3 quartz halogen bulb, clam		12

MATERIALS	Plastic housing, glass lens, stainless steel bracket
VOLT/AMP	12.8VDC - 4.5A
WT/DIMS	0.663 lb. / 5.875" x 3" x 2.75"
WARRANTY	Three Year Warranty



DL55 SERIES 55W Marine Flood Lights



DL55CS

- Flood light with heavy duty plastic housing, glass lens
- 12V 55W H3 halogen bulb
- Includes both lead and ground wires
- Stainless steel mounting bracket

BULK P/N	POLYPACK P/N	DESCRIPTION	QTY
RETAIL			
DL55CS	55W marine flood light, clam		6
A700	12V 55W H3 quartz halogen bulb, clam		12

MATERIALS	Plastic housing, glass lens, stainless steel bracket
VOLT/AMP	12.8VDC - 4.5A
WT/DIMS	1.333 lb. / 6.25" x 4.25" x 3"
WARRANTY	Three Year Warranty

QH16CTS & QH36CTS 55W Halogen Area Lights

- Area lights with post mount bases
- 12V 35W H3 halogen bulb
- Include both lead and ground wires
- QH36CTS has multi-directional bracket that adjusts both horizontally and vertically and stainless steel hardware

BULK P/N	POLYPACK P/N	DESCRIPTION	QTY
AREA LIGHT			
QH16CTS	QH16CTSP	Post mount area light	50
QH36CTS	QH36CTSP	Multi-directional post mount area light with stainless steel hardware	50
RETAIL			
A700	12V 55W H3 quartz halogen bulb, clam		12

MATERIALS	Plastic housing, glass lens
VOLT/AMP	12.8VDC - 4.5A
WT/DIMS	0.663 lb. / 5.875" x 3" x 2.75"
WARRANTY	Three Year Warranty



QH16CTS



QH36CTS

HALOGEN LIGHTS



RVSTL60/61 SERIES LED Low Profile RV Combination Tail Lights



RVSTL60
RVSTLB60

- 9-LED combination stop/turn/tail light for surface mount
- Driver side lights include 3-LED license plate illuminator and mounting bracket
- Snap-on, replaceable lens
- Available with white or black base
- Hard wired, ground wire included



RVSTL61



RVSTLB61

BULK P/N	POLYPACK P/N	DESCRIPTION	QTY
LED RV COMBINATION TAIL LIGHTS - 9 DIODES			

RVSTL60	RVSTL60P	Passenger side, white base	48
RVSTL61	RVSTL61P	Driver side, white base	48
RVSTLB60	RVSTLB60P	Passenger side, black base	48
RVSTLB61	RVSTLB61P	Driver side, black base	48

ACCESSORIES

RV60BK	RV60BKP	Wedge base mounting bezel, white	100
AST60B	AST60BP	Tail light lens, passenger side	10
AST61B	AST61BP	Tail light lens, driver side	10

FMVSS	A S2 T2 I6
MATERIALS	Acrylic lens and plastic housing
VOLT/AMP	12.8VDC - .243A Stop/Turn, .046A Tail
WT/DIMS	RVSTL60: .419 lb. / 8.625" x 3.188" x 2.25" RVSTL61: .419 lb. / 8.625" x 5" x 2.25"
WARRANTY	Lifetime LED Warranty

RV COMBINATION
TAIL LIGHTS

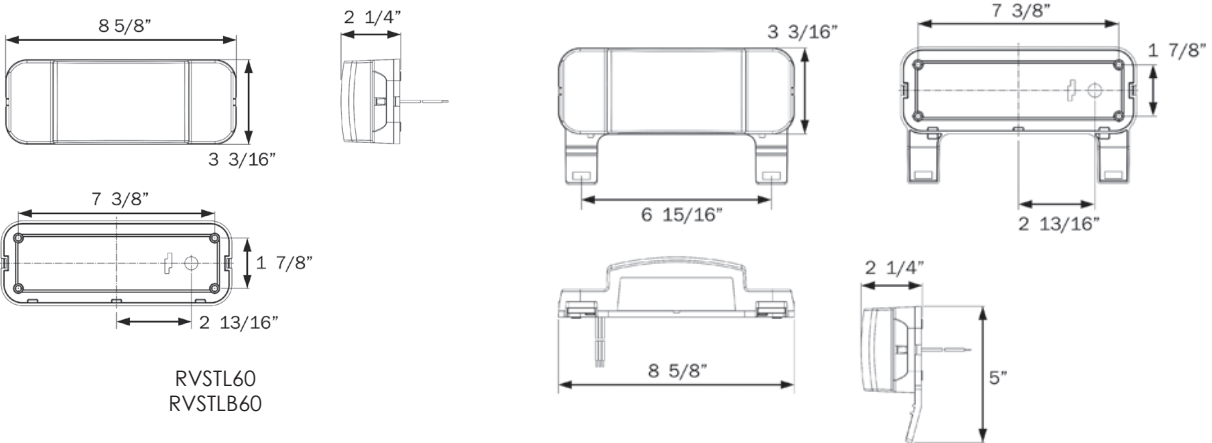

RVSTL61
RVSTLB61

RVST60/61 SERIES Low Profile RV Combination Tail Lights

- Combination stop/turn/tail light for surface mount
- Driver side lights include license plate illuminator and mounting bracket
- Snap-on lens and replaceable bulb
- Available with white or black base
- Hard wired, ground wire included



RVST60
RVSTB60



RVST61



RVSTB61



RV60BK

BULK P/N	POLYPACK P/N	DESCRIPTION	QTY
RV COMBINATION TAIL LIGHTS			
RVST60	RVST60P	Passenger side RV tail light, white base	48
RVST61	RVST61P	Driver side RV tail light, white base	48
RVSTB60	RVSTB60P	Passenger side RV tail light, black base	48
RVSTB61	RVSTB61P	Driver side RV tail light, black base	48
ACCESSORIES			
AST60B	AST60BP	Tail light lens, RVST60	10
AST61B	AST61BP	Tail light lens, RVST61	10
RV60BK	RV60BKP	Wedge base mounting bezel, white	100
A1157B	A1157BP	1157 replacement bulb	50

FMVSS	A S2 T2 I6
MATERIALS	Acrylic lens and plastic housing
VOLT/AMP	12.8VDC - 2.65A Stop, 2.10A Tail
WT/DIMS	RVST60: .419 lb. / 8.625" x 3.188" x 2.25" RVST61: .419 lb. / 8.625" x 5" x 2.25"
WARRANTY	Three Year Warranty

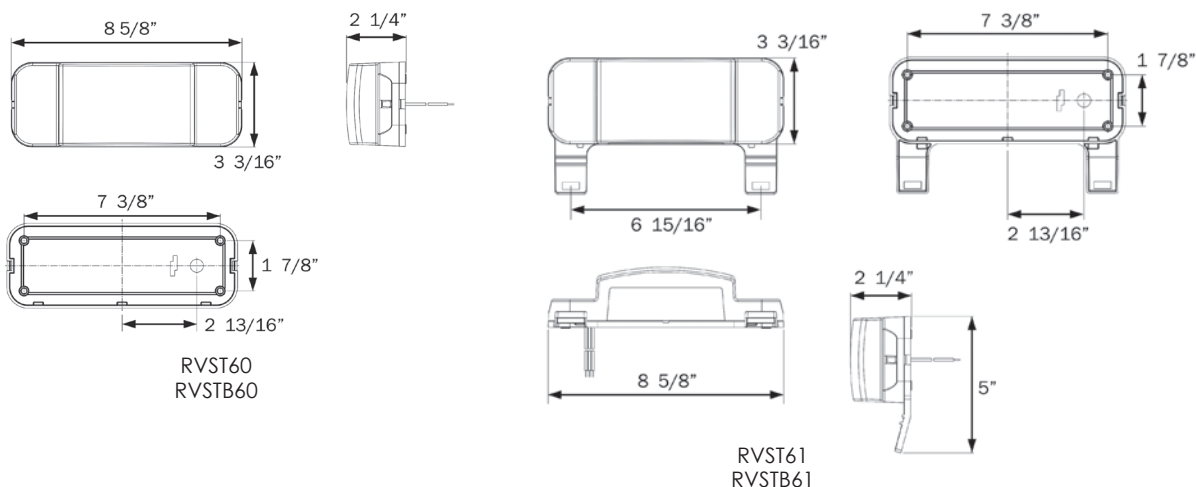

RV COMBINATION
TAIL LIGHTS



RVST50/51 SERIES RV Combination Tail Lights

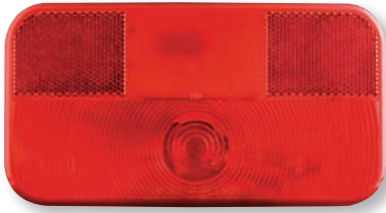

RVST50
RVSTB50



RVST51



RVSTB51



RV50BK

- Combination stop/turn/tail light for surface mount
- Driver side lights include license plate illuminator and mounting bracket
- Snap-on lens and replaceable bulb
- Available with white or black base
- Hard wired, ground wire included

BULK P/N	POLYPACK P/N	DESCRIPTION	QTY
RV COMBINATION TAIL LIGHTS			
RVST50	RVST50P	Passenger side RV tail light, white base	48
RVST51	RVST51P	Driver side RV tail light, white base	48
RVSTB50	RVSTB50P	Passenger side RV tail light, black base	48
RVSTB51	RVSTB51P	Driver side RV tail light, black base	48
ACCESSORIES			
AST50B	AST50BP	Tail light lens, RVST50	10
AST51B	AST51BP	Tail light lens, RVST51	10
RV50BK	RV50BKP	Wedge base mounting bezel, white	100
A2057B	A2057BP	2057 replacement bulb	50

FMVSS	RVST50: A I S T; RVST51: A I S T L
MATERIALS	Acrylic lens and plastic housing
VOLT/AMP	12.8VDC - 2.4A Stop, 0.4A Tail
WT/DIMS	RVST50: .419 lb. / 8.625" x 4.625" x 2.063" RVST51: .419 lb. / 8.625" x 6.313" x 2.063"
WARRANTY	Three Year Warranty

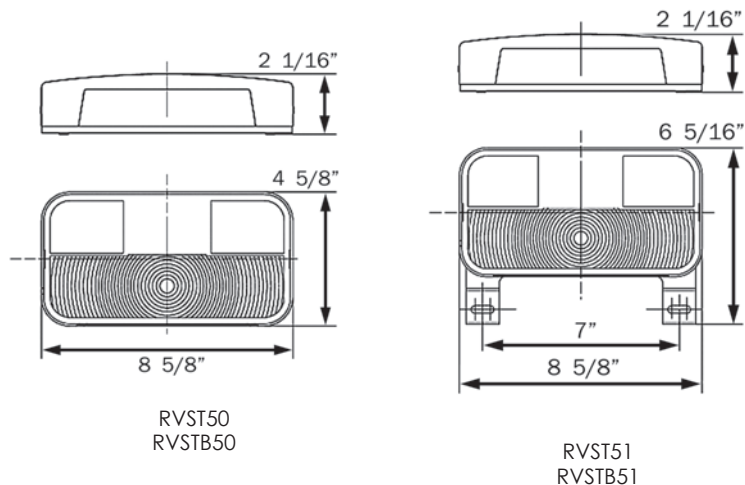

RV COMBINATION
TAIL LIGHTS

RVST55/56 SERIES RV Combination Tail Lights with Back-Up Lights

- Combination stop/turn/tail/back-up light for surface mount
- Driver side lights include license plate illuminator and mounting bracket
- Snap-on lens and replaceable bulbs (2057 tail/1156 back-up)
- Hard wired, ground wire included

BULK P/N	POLYPACK P/N	DESCRIPTION	QTY
RV COMBINATION TAIL LIGHTS			
RVST55	RVST55P	Passenger side RV tail light, white base	48
RVST56	RVST56P	Driver side RV tail light, white base	48
RVBST55	RVBST55P	Passenger side RV tail light, black base	48
RVBST56	RVBST56P	Driver side RV tail light, black base	48
ACCESSORIES			
AST55B	AST55BP	Tail light lens, RVST55	10
AST56B	AST56BP	Tail light lens, RVST56	10
RV50BK	RV50BKP	Wedge base mounting bezel, white	100
A2057B	A2057BP	2057 replacement bulb	50

FMVSS	RVST55: A I S T; RVST56: A I S T L
MATERIALS	Acrylic lens and plastic housing
VOLT/AMP	12.8VDC - 2.2A Stop, 0.4A Tail, 2.1A Back-Up
WT/DIMS	RVST55: .419 lb. / 8.625" x 4.625" x 2.063" RVST56: .419 lb. / 8.625" x 6.313" x 2.063"
WARRANTY	Three Year Warranty

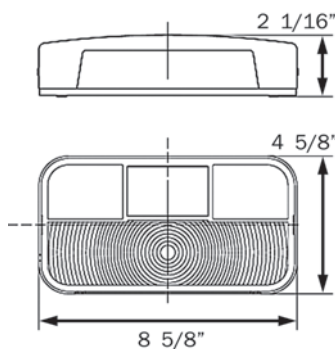

RVST55
RVBST55

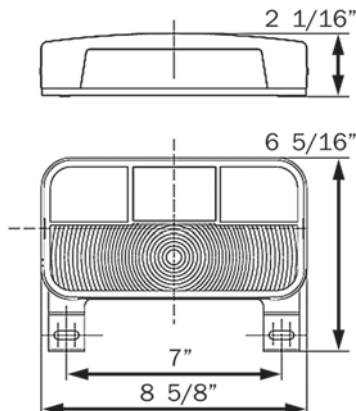

RVST56
RVBST56



RVST55
RVBST55



RVST56



RVBST56



RV50BK

RV COMBINATION
TAIL LIGHTS



RVPL1/3 SERIES Rectangular Porch/Utility Lights

- Surface mount porch/cabin lights (CSA/UL listed)
- White housing with snap-on lens and replaceable bulb (1141)
- Available with yellow or clear lens
- Hard wired with separate ground wire



RVPL1A



RVPL1C



RVPL3C

BULK P/N	POLYPACK P/N	DESCRIPTION	QTY
YELLOW PORCH LIGHTS			
RVPL1A	RVPL1AP	Yellow porch light, no switch	50
CLEAR UTILITY LIGHTS			
RVPL1C	RVPL1CP	Clear utility light, no switch	50
RVPL3C	RVPL3CP	Clear utility light with switch	50
ACCESSORIES			
APL1AB	APL1ABP	Yellow replacement lens	10
APL1CB	APL1CBP	Clear replacement lens	10

CERTIFICATION	CSA / UL
MATERIALS	Acrylic lens and plastic housing
VOLT/AMP	12.8VDC - 1.4A
WT/DIMS	.419 lb. / 6.375" x 3.5" x 2.094"
WARRANTY	Three Year Warranty

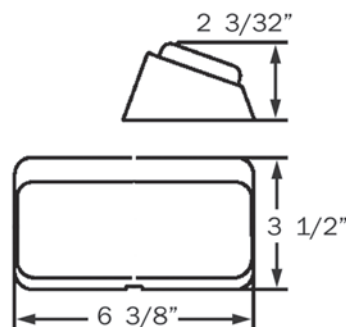



RVPL5/7 SERIES Oval Porch/Utility Lights

- Surface mount porch utility lights available with or without switch
- White or black housing with snap-on lens and replaceable bulb (1141)
- Available with yellow or clear lens
- Hard wired with separate ground wire

BULK P/N	POLYPACK P/N	DESCRIPTION	QTY
YELLOW PORCH LIGHTS			
RVPL5A	RVPL5AP	Yellow porch light, white housing, no switch	50
RVPL5AB	RVPL5ABP	Yellow porch light, black housing, no switch	50
RVPL7A	RVPL7AP	Yellow porch light, white housing, with switch	50
RVPL7AB	RVPL7ABP	Yellow porch light, black housing, with switch	50
CLEAR UTILITY LIGHTS			
RVPL5C	RVPL5CP	Clear utility light, white housing, no switch	50
RVPL5CB	RVPL5CBP	Clear utility light, black housing, no switch	50
RVPL7C	RVPL7CP	Clear utility light, white housing, with switch	50
RVPL7CB	RVPL7CBP	Clear utility light, black housing, with switch	50
ACCESSORIES			
APL5AB	APL5ABP	Yellow replacement lens	10
APL5CB	APL5CBP	Clear replacement lens	10

CERTIFICATION	CSA / UL
MATERIALS	Acrylic lens and plastic housing
VOLT/AMP	12.8VDC - 1.4A
WT/DIMS	.265 lb. / 6.25" x 3.438" x 1.875"
WARRANTY	Three Year Warranty

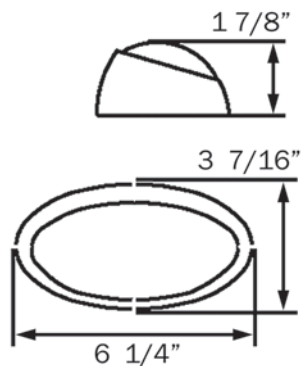

RVPL5A



RVPL5AB



RVPL7A



RVPL7AB



RVPL5C



RVPL5CB



RVPL7C



RVPL7CB

RV PORCH/CABIN
& SECURITY LIGHTS



RVPL8 SERIES Low Profile Porch/Utility Lights



RVPL8AB

- Surface mount porch utility lights
- Snap-on lens and replaceable bulb (12V 10W halogen)
- Available with yellow or clear lens
- Hard wired with separate ground wire



RVPL8C



RVPL8CB



RVPL9CC

BULK P/N	POLYPACK P/N	DESCRIPTION	QTY
YELLOW PORCH LIGHTS			
RVPL8AB	RVPL8ABP	Yellow porch light, black housing	50
CLEAR UTILITY LIGHTS			
RVPL8C	RVPL8CP	Clear utility light, white housing	50
RVPL8CB	RVPL8CBP	Clear utility light, black housing	50
RVPL9CC	RVPL9CCP	Clear utility light, chrome housing	50

CERTIFICATION	CSA
MATERIALS	Acrylic lens and plastic housing
VOLT/AMP	12.8VDC - 0.78A
WT/DIMS	.265 lb. / 10" x 3.5" x 2.125"
WARRANTY	Three Year Warranty

RVSL21/31 SERIES
Scare Lights

- Surface mount security lights with mounting gasket (CSA)
- Stainless steel or white housing with screw-on lens and replaceable bulb (1156)
- Hard wired with separate ground wire

BULK P/N	POLYPACK P/N	DESCRIPTION	QTY
CLEAR SECURITY LIGHTS			
RVSL21	RVSL21P	Scare light, stainless housing	25
RVSL31	RVSL31P	Scare light, white housing	25

CERTIFICATION	CSA
MATERIALS	Acrylic lens, metal housing
VOLT/AMP	12.8VDC - 1.4A
WT/DIMS	0.97 lb. / 8.656" x 8.656" x 1.969"
WARRANTY	Three Year Warranty

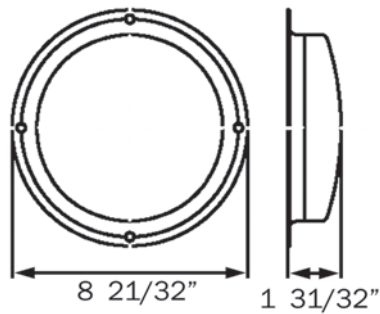

RVSL21



RVSL31

RV PORCH/CABIN
& SECURITY LIGHTS



RVILL39 LED Surface Mount Interior Ceiling Light



RVILL39

- Surface mount ceiling light with switch
- Effective lumen output 230 lm
- Replaceable white snap-on bezel
- Dual power: use with 12VDC and 24VDC systems
- 18-gauge, 6-inch lead and ground wire

BULK P/N	POLYPACK P/N	DESCRIPTION	QTY
INTERIOR CEILING LIGHTS - 9 DIODES			
RVILL39	RVILL39P	Interior light with switch	10

Raw lumen output: 280 lm
Effective lumen output: 230 lm

MATERIALS	Clear PMMA lens, ABS bezel
VOLT/AMP	12.8VDC - 0.25A
WT/DIMS	.325 lb. / 7.188" x 5.188" x 1.438"
WARRANTY	Three Year Warranty

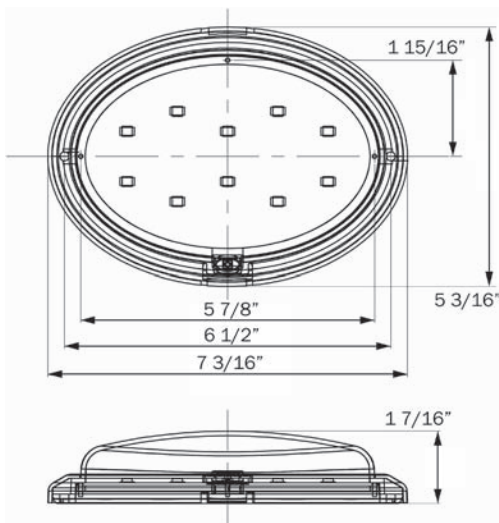



RVILL33/34 SERIES LED Interior RV Lights

- Surface mount interior lights with switch (CSA)
- Single or double lights with snap-on lens
- LED technology – uses 90% less energy
- Hard wired with separate ground wire

BULK P/N	POLYPACK P/N	DESCRIPTION	QTY
LED INTERIOR LIGHTS			
RVILL33	RVILL33P	Single, on/off switch, 11 diodes	50
RVILL34	RVILL34P	Double, on/off switch, 22 diodes	25
ACCESSORIES			
AIL32B	AIL32BP	Clear replacement lens for RVIF31/32	10

RVILL33 lumen output (raw/effective): 460 lm / 407 lm
RVILL34 lumen output (raw/effective): 920 lm / 815 lm

CERTIFICATION	CSA
MATERIALS	Polycarbonate lens and plastic housing
VOLT/AMP	RVILL33: 12.8VDC - 0.3A RVILL34: 12.8VDC - 0.6A
WT/DIMS	RVILL33: .794 lb. / 6.377" x 4.173" x 1.787" RVILL34: 1.587 lb. / 10.283" x 4.173" x 1.787"
WARRANTY	Three Year Warranty



RVILL33



RVILL34

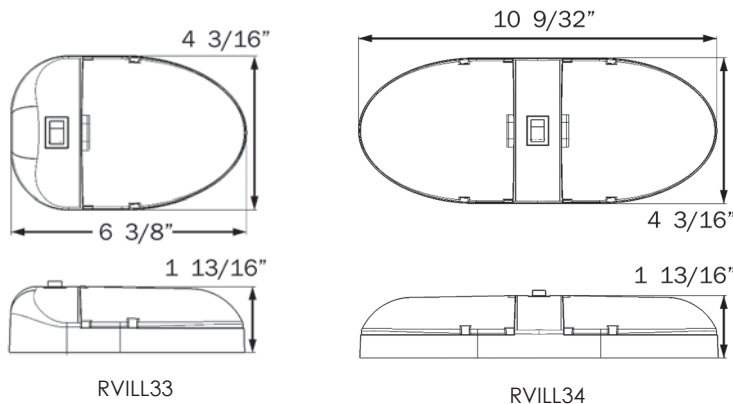

RV INTERIOR
LIGHTS



RVILL31/32 SERIES LED RV Interior Lights

- Surface mount interior lights with switch (CSA)
- Aero style single or double lights with snap-on lens
- LED technology – uses 90% less energy
- Hard wired with separate ground wire



RVILL31



RVILL32

BULK P/N	POLYPACK P/N	DESCRIPTION	QTY
LED INTERIOR LIGHTS			
RVILL31	RVILL31P	Single, on/off switch, 6 diodes	100
RVILL31PB	-	Single, on/off switch, .180 male bullet on power, eyelet on ground	100
RVILL31PGB	-	Single, on/off switch, .180 male bullet on power, .180 female barrel on ground	100
RVILL32	RVILL32P	Double, on/off switch, 12 diodes	50
ACCESSORIES			
AIL32B	-	Replacement lens	200

RVILL31 lumen output: 160 lm

RVILL32 lumen output: 300 lm

CERTIFICATION	CSA
MATERIALS	Polycarbonate lens and plastic housing
VOLT/AMP	RVILL31: 12.8VDC - 0.5A RVILL32: 12.8VDC - 1.0A
WT/DIMS	RVILL31: .794 lb. / 6.875" x 4.125" x 1.75" RVILL32: 1.587 lb. / 10.375" x 4.125" x 1.75"
WARRANTY	Three Year Warranty

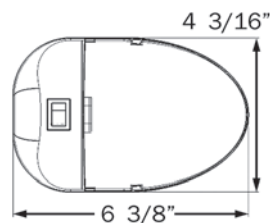

RVILL31

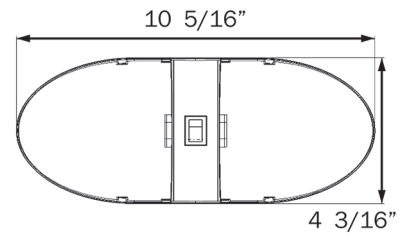
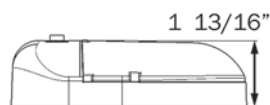

RVILL32

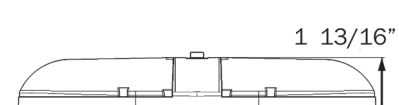

RVIL35/36 SERIES Interior RV Lights



- Surface mount interior lights with switch (CSA)
- Single or double lights with snap-on lens and replaceable bulb
- Hard wired with separate ground wire

BULK P/N	POLYPACK P/N	DESCRIPTION	QTY
INTERIOR RV LIGHTS			
RVIL35	RVIL35P	Single, on/off switch	50
RVIL36	RVIL36P	Double, on/off switch	25
ACCESSORIES			
ARVIL35B	-	Replacement lens	10
A921B	-	921 replacement bulb	50

CERTIFICATION	CSA
MATERIALS	Polycarbonate lens and plastic housing
VOLT/AMP	RVIL35: 12.8VDC - 1.3A RVIL36: 12.8VDC - 2.6A
WT/DIMS	RVIL35: .794 lb. / 6.375" x 4.125" x 1.75" RVIL36: 1.587 lb. / 10.25" x 4.125" x 1.75"
WARRANTY	Three Year Warranty



RVIL35



RVIL36

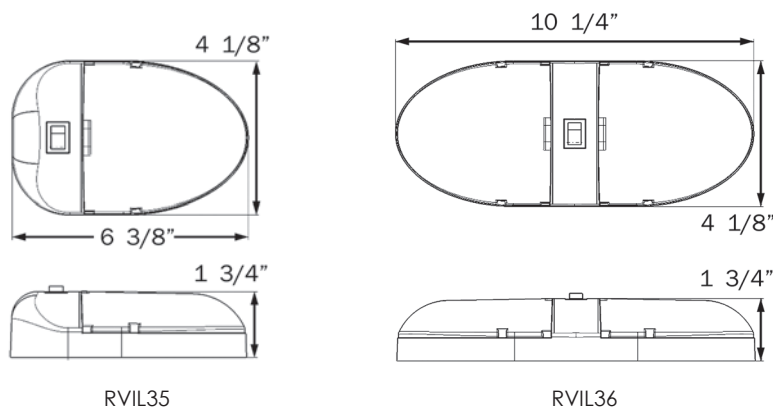

RV INTERIOR LIGHTS



RVIL21/22 SERIES RV Interior Lights

- Surface mount ceiling lights with switch (CSA)
- Single or double lights with snap-on lens and replaceable bulb
- Hard wired with separate ground wire



RVIL21



RVIL22

BULK P/N	POLYPACK P/N	DESCRIPTION	QTY
RV INTERIOR LIGHTS			
RVIL21	RVIL21P	Single, on/off switch	50
RVIL22	RVIL22P	Double, on/off switch	25
ACCESSORIES			
AIL21B	AIL21BP	Clear replacement lens	10
A921B	-	921 replacement bulb	50

CERTIFICATION	CSA / UL
MATERIALS	Acrylic lens and plastic housing
VOLT/AMP	RVIL21: 12.8VDC - 0.5A RVIL22: 12.8VDC - 1.4A
WT/DIMS	RVIL21: .794 lb. / 7.078" x 4.25" x 1.969" RVIL22: 1.587 lb. / 12" x 4.25" x 1.844"
WARRANTY	Three Year Warranty

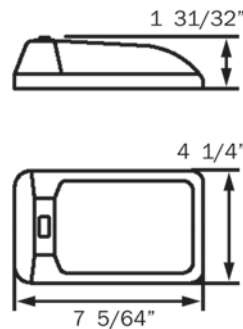

RVIL21

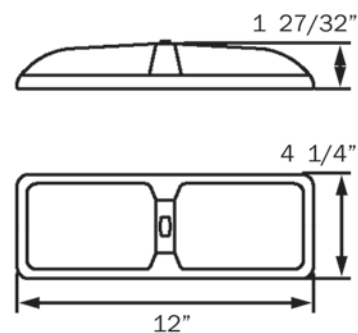

RVIL22



RVIM46 & RVFL51 SERIES Portable Interior Lights

- Mount with clamps for portability
- Include coil cords with male plugs
- RVIM46 is a single light with on/off switch
- RVFL51 is a reading light and fan with switch for each; replaceable bulb (912)

BULK P/N	POLYPACK P/N	DESCRIPTION	QTY
PORTABLE LIGHTS			
RVIM46	RVIM46P	Light with coil cord, male plug	50
RVFL51	RVFL51P	Reading light with fan, coil cord, male plug	24
ACCESSORIES			
RVC100	RVC100P	Bunk light adaptor with jack (CSA)	100
A921B	-	921 replacement bulb for RVIM46	50

CERTIFICATION	CSA
MATERIALS	Polycarbonate lens and plastic housing
VOLT/AMP	RVIM46: 12.8VDC - 0.8A RVFL51: 12.8VDC - 1.3A (fan and light)
WT/DIMS	RVIM46: .794 lb. / 7" x 4.25" x 3" RVFL51: 1.587 lb. / 8.5" x 5.625" x 2.875" RVC100: .6 lb. / 2.484" x 2.484" x 1.438"
WARRANTY	Three Year Warranty



RVIM46



RVFL51



RVC100

RV INTERIOR LIGHTS



COMPACT COURTESY LIGHTS

- Choose from surface mount and flush mount lights
- Hard wired, include lead and ground



16802B



19102B

BULK P/N	POLYPACK P/N	DESCRIPTION	QTY
COURTESY LIGHTS			
16802B	16802P	Black hooded light (bulb 194; .24A)	100
19102B	19102P	Flush mount light (bulb 194; .24A)	50

CERTIFICATION	CSA
MATERIALS	Plastic
VOLT	12.8VDC
WT/DIMS	16802B: .2 lb. / 2.75" x 1.75" x 1.5" 19102B: .2 lb. / 4.5" x 1.25"
WARRANTY	Three Year Warranty



CHROME COURTESY LIGHTS

- Hooded lights with chrome finish, white lens
- Hard wired, include lead and ground



068NME



068WMTE

BULK P/N	POLYPACK P/N	DESCRIPTION	QTY
COURTESY LIGHTS			
068NME	068NMEP	Snap-in light	50
068WMTE	068WMTEP	Light with stainless steel mounting plate	50

CERTIFICATION	UL
MATERIALS	Metal (068WMTE - stainless steel plate), polycarbonate lens
VOLT/AMP	12.8VDC - 0.59A (bulb 67, 12V 4CP)
WT/DIMS	068NME: .2 lb. / 1.5" x 1.5" x 2" 068WMTE: .2 lb. / 2.75" x 1.625" x 2"
WARRANTY	Three Year Warranty

WATERPROOF COURTESY LIGHT

- Submersible design with gaskets
- Hard wired, includes lead and ground

BULK P/N	POLYPACK P/N	DESCRIPTION	QTY
COURTESY LIGHT			
24074B	24074P	Rear mount light with nut	50

CERTIFICATION	CSA
MATERIALS	Plastic
VOLT/AMP	12.8VDC - 1.25A (bulb 194)
WT/DIMS	.2 lb. / 2" x 2" x 1.75"
WARRANTY	Three Year Warranty



24074B

OVAL COURTESY LIGHTS

- Semi-recessed with clear lens
- Hard wired, includes lead and ground

BULK P/N	POLYPACK P/N	DESCRIPTION	QTY
COURTESY LIGHTS			
04440013B	04440013P	Medium saddle finish	50
04440016B	04440016P	Dark charcoal finish	100
2407764B	2407764P	White finish	100
2407765B	2407765P	Dream white finish	50
2407768B	2407768P	Oyster finish	50
2407771C	2407771CP	Black finish, chrome reflector	50

CERTIFICATION	CSA
MATERIALS	Plastic
VOLT/AMP	12.8VDC - .17A (bulb 161, wedge base)
WT/DIMS	.2 lb. / 4" x 2.625" x 1.25"
WARRANTY	Three Year Warranty



TOP TO BOTTOM:
 04440013B
 04440016B
 2407764B
 2407765B
 2407768B
 2407771C

RV COURTESY LIGHTS



CELESTIAL SERIES Recess Mount Fluorescent



17918386B

CUT-OUT: 18.25" x 5" x 1.25" D

- Dual bulb light with recessed on/off switch
- Aluminum extrusion construction with powder coated finish; parabolic chrome reflector, designer lens, white end caps
- Hard wired, includes lead and ground

BULK P/N	POLYPACK P/N	DESCRIPTION	QTY
FLUORESCENT LIGHT			
17918386B	17918386BP	18" recess mount fluorescent light	10
17612280B	-	12" recess mount fluorescent light	10

CERTIFICATION	CSA
MATERIALS	Aluminum base, plastic end caps and lens
VOLT/AMP	18": 12.8VDC - 2.43A (bulb 30031000) 12": 12.8VDC - 1.25A (bulb 30000000)
WT/DIMS	18": 2.5 lb. / 19.5" x 6.5" x 1.875" 12": 1.7 lb. / 13.75" x 6.5" x 1.75"
WARRANTY	Three Year Warranty



PULSAR SERIES Surface Mount Fluorescent



17918190B

- Dual bulb lights with recessed on/off switch
- Aluminum extrusion construction with powder coated finish; parabolic chrome reflector, designer lens, white end caps
- Hard wired, include lead and ground

BULK P/N	POLYPACK P/N	DESCRIPTION	QTY
FLUORESCENT LIGHTS			
17918190B	17918190BP	18" fluorescent, cool white	10
17612195B	-	12" fluorescent, cool white	10



17612195B

CERTIFICATION	CSA
MATERIALS	Aluminum base, plastic end caps and lens
VOLT/AMP	18": 12.8VDC - 2.43A (bulb 30031000) 12": 12.8VDC - 1.25A (bulb 30000000)
WT/DIMS	18": 2.5 lb. / 20" x 5.5" x 1.5" 12": 1.7 lb. / 14.50" x 5.5" x 1.375"
WARRANTY	Three Year Warranty

ALPHA SERIES

Surface Mount Fluorescent



- Dual bulb lights with recessed on/off switch
- Stamped metal construction with powder coated finish; parabolic chrome reflector, designer lens, white end caps
- Hard wired, include lead and ground



17612125B

BULK P/N	POLYPACK P/N	DESCRIPTION	QTY
FLUORESCENT LIGHTS			
17918135B	17918135BP	18" fluorescent, cool white	1
17612125B	-	12" fluorescent, cool white	20

CERTIFICATION	CSA
MATERIALS	Metal base, plastic end caps and lens
VOLT/AMP	18": 12.8VDC - 2.43A (bulb 30031000) 12": 12.8VDC - 1.25A (bulb 30000000)
WT/DIMS	18": 2.8 lb. / 18.375" x 5.75" x 1.375" 12": 1.6 lb. / 14.5" x 5.5" x 1.375"
WARRANTY	Three Year Warranty

RV FLUORESCENT LIGHTS



TRITON DECO LIGHT

- Decorative wall light with compact base
- Brushed nickel fixture, alabaster globe



15011001B

BULK P/N	POLYPACK P/N	DESCRIPTION	QTY
DECO LIGHT			
15011001B	-	Wall light, brushed nickel	20

CERTIFICATION	CSA / NRTL/C
MATERIALS	Metal fixture, glass lens
VOLT/AMP	12.8VDC - 0.78A (bulb 10W G4 xenon)
WT/DIMS	.8 lb. / 3.25" x 5.5" x 6"
WARRANTY	Three Year Warranty



AURORA SERIES Bullet Lights

- Metal directional light with adjustable bracket and switch
- Surface mount with no exposed fasteners
- Hard wired, include lead and ground
- Bulb 922 wedge base incandescent



04010009B

BULK P/N	POLYPACK P/N	DESCRIPTION	QTY
BULLET LIGHTS			
04010009B	-	Chrome, black switch	30
04010040B	04010040P	Brushed nickel, black switch	30

CERTIFICATION	CSA
MATERIALS	Metal housing
VOLT/AMP	12.8VDC - 0.98A (bulb 922 wedge base)
WT/DIMS	.5 lb. / 2.75" x 3.75" x 4.625"
WARRANTY	Three Year Warranty

CO-PILOT LIGHTS Halogen and Incandescent

- Map lights for sidewalls, drink trays and dashboards
- Switch is incorporated into light design
- Flexible 18" arm

BULK P/N	POLYPACK P/N	DESCRIPTION	QTY
CO-PILOT LIGHTS			
03001175B	03001175P	Halogen (5W bulb/0.35A)	10
03001150B	03001150P	Incandescent (1816 bulb/0.27A)	10

CERTIFICATION	UL
MATERIALS	Metal, black finish
VOLT	12.8VDC
WT/DIMS	.6 lb. / 18"
WARRANTY	Three Year Warranty



03001175B

RV DIRECTIONAL
LIGHTS



GALAXY LED SERIES LED Directional Lights

- Recess mount lights with swivel globes and switches
- Removable snap-on trim ring, sold separately
- Hard wired, includes lead and ground



240047171LB & 24004TR71



240147171LB & 24014TR71

BULK P/N	POLYPACK P/N	DESCRIPTION	QTY
LED DIRECTIONAL LIGHTS			
240047171LB	-	LED Single fixture	50
240147171LB	-	LED Double fixture	20
24004TR71	24004TR71P	Trim ring for single fixture, black	50
24014TR71	24014TR71P	Trim ring for double fixture, black	50

CERTIFICATION	CSA
MATERIALS	Plastic
VOLT/AMP	Single: 12.8VDC - 0.020A Double: 12.8VDC - 0.054A
WT/DIMS	Single: .15 lb. / 3.5" x 4.875" x 1.75" Double: .31 lb. / 3.5" x 9.625" x 1.75"
WARRANTY	Lifetime LED Warranty



GALAXY SERIES Directional Lights

- Recess mount lights with swivel globes and switches
- Removable snap-on trim ring, sold separately
- Hard wired, includes lead and ground



240047171B & 24004TR71



240147171B & 24014TR71

BULK P/N	POLYPACK P/N	DESCRIPTION	QTY
DIRECTIONAL LIGHTS			
240047171B	240047171P	Single fixture	50
240147171B	240147171P	Double fixture	20
24004002B	-	Single fixture with reflector & 5W bulb	50
06001022B	06001022P	Single fixture with reflector	50
24004TR71	24004TR71P	Trim ring for single fixture, black	50
24014TR71	24014TR71P	Trim ring for double fixture, black	50

CERTIFICATION	CSA
MATERIALS	Plastic
VOLT/AMP	Single: 12.8VDC - 0.35A (bulb 168 wedge base) Double: 12.8VDC - 0.70A (bulb 168 wedge base)
WT/DIMS	Single: .24 lb. / 3.5" x 4.875" x 1.75" Double: .47 lb. / 3.5" x 9.625" x 1.75"
WARRANTY	Three Year Warranty

UNITEK LED SERIES LED Directional Lights

- Recess mount LED fixtures with multi-locking pivoting globes that activate lights
- Removable snap-on trim ring, sold separately
- Three-terminal hook-up for dome light application

BULK P/N	POLYPACK P/N	DESCRIPTION	QTY
LED DIRECTIONAL LIGHTS			
825LED	-	Single fixture, 9 diodes, black	50
826LED	-	Double fixture, 18 diodes, black	50
825TR02	825TR02P	Single trim ring, black	50
826TR02	826TR02P	Double trim ring, black	25
826TR12	-	Double trim ring, light gray	25
826TR90	-	Double trim ring, platinum silver	25

CERTIFICATION	UL
MATERIALS	Plastic
VOLT/AMP	12.8VDC - Single 0.35A , Double 0.70A
WT/DIMS	Single: .25 lb. / 4.125" x 3.5" x 1.5" Double: .48 lb. / 7" x 3.875" x 1.375"
WARRANTY	Lifetime LED Warranty



825LED & 825TR02



826LED & 826TR02

UNITEK SERIES Directional Lights

- Recess mount fixtures with multi-locking pivoting globes that activate lights
- Removable lenses allow easy bulb replacement
- Removable snap-on trim ring, sold separately
- Three-terminal hook-up for dome light application

BULK P/N	POLYPACK P/N	DESCRIPTION	QTY
DIRECTIONAL LIGHTS			
825L	825LP	Single fixture, black	50
826L	826LP	Double fixture, black	50
See complete listing of trim rings above			

CERTIFICATION	UL
MATERIALS	Plastic
VOLT/AMP	Single: 12.8VDC - 0.35A (bulb 168 wedge base) Double: 12.8VDC - 0.70A (bulb 168 wedge base)
WT/DIMS	Single: .25 lb. / 4.125" x 3.5" x 1.5" Double: .48 lb. / 7" x 3.875" x 1.375"
WARRANTY	Three Year Warranty



825L & 825TR02



826L & 826TR02



ULTRATEK SERIES Directional Lights



06001013B & 3802071BZL



06001014B & 3801071BZL

- Flush mount fixtures with pivoting globes that activate lights
- Removable snap-on trim ring, sold separately
- Removable lens for easy bulb replacement
- Three-terminal hook-up for dome light application

BULK P/N	POLYPACK P/N	DESCRIPTION	QTY
DIRECTIONAL LIGHTS			
06001013B	06001013P	Single fixture, black	120
06001014B	06001014P	Double fixture, black	120
3802071BZL	3802071BZLP	Single trim ring, black	30
3801071BZL	3801071BZLP	Double trim ring, black	30

CERTIFICATION	CSA / NRTL/C / ANSI/UL
MATERIALS	Plastic
VOLT/AMP	Single: 12.8VDC - 0.37A (bulb 590 xenon 4cp) Double: 12.8VDC - 0.74A (bulb 590 xenon 4cp)
WT/DIMS	Single: .27 lb. / 3.75" x 3.5" x 1.5" Double: .40 lb. / 5.875" x 3.5" x 1.5"
WARRANTY	Three Year Warranty

RV DIRECTIONAL LIGHTS



AUTOTEK SERIES Directional Lights



725022B



726022B

- Low profile aircraft-style lights with switch
- Removable grids allow easy bulb replacement
- Snap-on trim ring covers mounting screws
- Three-terminal hook-up for dome light application

BULK P/N	POLYPACK P/N	DESCRIPTION	QTY
DIRECTIONAL LIGHTS			
725022B	725022P	Single fixture, black	25
726022B	726022P	Double fixture, black	20

CERTIFICATION	CSA / UL
MATERIALS	Plastic
VOLT/AMP	Single: 12.8VDC - 0.69A (bulb 906 T5 wedge base) Double: 12.8VDC - 1.38A (bulb 906 T5 wedge base)
WT/DIMS	Single: .32 lb. / 4.625" x 3.5" x 2.25" Double: .52 lb. / 7.625" x 3.5" x 2.25"
WARRANTY	Three Year Warranty

EUROPA SERIES Directional Lights

- Choose from single recess mount and single/double surface mount series with on/off switches
- Prismatic reflector globes for bright directional beams
- Easy bulb replacement (168 wedge base)

BULK P/N	POLYPACK P/N	DESCRIPTION	QTY
RECESS MOUNT			
06001072B	06001072P	Single fixture, black	20
SURFACE MOUNT			
06001026B	06001026P	Single fixture, black	20
06001015B	06001015P	Double fixture, black	20
06001061B	06001061P	Double fixture plus dome light, black	20
CERTIFICATION	UL / CSA		
MATERIALS	Plastic		
VOLT/AMP	Single:	12.8VDC - 0.35A (bulb 168 wedge base)	
	Double:	12.8VDC - 0.70A (bulb 168 wedge base)	
WT/DIMS	06001072B/P:	.18 lb. / 4.5" x 3.75" x 1.75"	
	06001026B/P:	.16 lb. / 4.125" x 2.937" x 1.625"	
	06001015B/P:	.28 lb. / 2.75" x 6.25" x 1.75"	
	06001061B/P:	.46 lb. / 8.375" x 2.75" x 1.75"	
WARRANTY	Three Year Warranty		



06001072B



06001026B
06001015B
06001061B

EUROPA SERIES Ultrabright Directional Lights

- High output for bright, directional reading light
- Easy bulb replacement (1003 bayonet base)
- Separate switches for each bulb

BULK P/N	POLYPACK P/N	DESCRIPTION	QTY
ULTRA BRIGHT SURFACE MOUNT			
06001048B	06001048P	Single fixture, black	20
06001037B	06001037P	Double fixture, black	20
CERTIFICATION	UL		
MATERIALS	Plastic		
VOLT/AMP	Single:	12.8VDC - 0.94A (bulb 1003 bayonet base)	
	Double:	12.8VDC - 0.94A (bulb 1003 bayonet base)	
WT/DIMS	Single:	.25 lb. / 4" x 2.875" x 2.5"	
	Double:	.47 lb. / 6.125" x 2.75" x 2.625"	
WARRANTY	Three Year Warranty		



06001048B



06001037B



ODYSSEY SERIES Directional Light



0601B & 060102B

- Recess mount light with press on/off feature at lens
- Removable snap-on trim ring, sold separately
- Hard wired, includes lead and ground

BULK P/N	POLYPACK P/N	DESCRIPTION	QTY
DIRECTIONAL LIGHTS			
0601B	0601P	Light, black	200
060102B	060102P	Trim ring, black	50

CERTIFICATION	CSA / NRTL/C / ANSI/UL
MATERIALS	Plastic
VOLT	12.8VDC - 0.94A (bulb 906 T5 wedge base)
WT/DIMS	.26 lb. / 3.125" x 5" x 2"
WARRANTY	Three Year Warranty



STARGAZER SERIES Directional Lights



06001001B & 06300004B

- Recess mount fixtures with multi-locking, pivoting globes that activate lights
- Removable snap-on trim ring, sold separately
- Removable lens for easy bulb replacement
- Three-terminal hook-up for dome light application

BULK P/N	POLYPACK P/N	DESCRIPTION	QTY
DIRECTIONAL LIGHTS			
06001001B	06001001P	Single fixture, black	50
06002001B	06002001P	Double fixture, black	48
06300004B	06300004P	Single trim ring, black	50
06300003B	06300003P	Double trim ring, black	25



06002001B & 06300003B

CERTIFICATION	CSA / NRTL/C / ANSI/UL
MATERIALS	Plastic
VOLT/AMP	Single: 12.8VDC - 0.35A (bulb 168 wedge base) Double: 12.8VDC - 0.70A (bulb 168 wedge base)
WT/DIMS	Single: .25 lb. / 3.375" x 4" x 1.5" Double: .44 lb. / 7" x 3.875" x 1.5"
WARRANTY	Three Year Warranty

CENTURA SERIES

- Simple design with aluminum base, acrylic lens and single or dual switch
- Slim design: only 2.5" wide and 1.13" thick
- Available in 5.5" and 12.5" lengths

BULK P/N	POLYPACK P/N	DESCRIPTION	QTY
SURFACE MOUNT			
105500SP	-	Single bulb, 5.5"	50
105520B	105520BP	Triple bulb, 12.5"	25

MATERIALS	Aluminum base, acrylic lens		
VOLT/AMP	5.5":	12.8VDC - 0.97A (bulb 211)	
	12.5":	12.8VDC - 2.91A (bulb 211-2)	
WT/DIMS	5.5":	.20 lb. / 5.75" x 2.5" x 1.25"	
	12.5":	.44 lb. / 12.75" x 2.5" x 1.25"	
WARRANTY	Three Year Warranty		



105500SP



105520B

SLIMLINE SERIES

- Contemporary design with single or dual switch
- Low profile: 4" wide and only 1.5" thick
- Available in three lengths

BULK P/N	POLYPACK P/N	DESCRIPTION	QTY
SURFACE MOUNT			
18543910B	-	Single bulb, 4", no switch, white	25
18543916B	-	Single bulb, 5.5", switch, white	100
18543936B	-	Two bulb, 7.5", dual switch, white	20

MATERIALS	Plastic		
VOLT/AMP	Single:	12.8VDC - 1.0A (bulb 912)	
	Dual:	12.8VDC - 2.0A (bulb 912)	
WT/DIMS	4":	.4 lb. / 4" x 4" x 1.5"	
	5.5":	.6 lb. / 5.5" x 4" x 1.5"	
	7":	.8 lb. / 7" x 4" x 1.5"	
WARRANTY	Three Year Warranty		



18543910B



18543916B



18543936B



24113160B

24113160B DOME LIGHT

- Halogen dome light with switch for general illumination
- Designed for overhead or bulkhead surface mount
- White plastic construction with frosted lens

BULK P/N	POLYPACK P/N	DESCRIPTION	QTY
DOMES LIGHT			
24113160B	24113160P	5.75" white dome light	30

CERTIFICATION	NRTL/C
MATERIALS	Plastic
VOLT/AMP	12.8VDC - 0.78A (bulb G4 bi-pin)
WT/DIMS	.4 lb. / 5.75" x 5.75" x 1.5"
WARRANTY	Three Year Warranty



69000200B

69000200B DOME LIGHT

- Stainless steel interior dome light for recess mount
- Polished finish, two-wire, replaceable 1142 bulb

BULK P/N	POLYPACK P/N	DESCRIPTION	QTY
DOMES LIGHT			
69000200B	69000200P	Dome light, polished stainless steel	40

MATERIALS	Stainless steel housing, polycarbonate lens
VOLT/AMP	12.8VDC - 1.25A (bulb 1142)
WT/DIMS	.5 lb. / 5.5" x 5.5" x 1.5"
WARRANTY	Three Year Warranty



357B

357B DOME LIGHT

- 8.5" semi-recess mount light with one halogen and one incandescent bulb
- Chrome plated housing, Lexan lens, replaceable bulbs

BULK P/N	POLYPACK P/N	DESCRIPTION	QTY
DOMES LIGHT			
357B	357P	Dome light, chrome-plated	40

MATERIALS	Metal housing, Lexan lens
VOLT/AMP	12.8VDC - 2.79A (GH9 37.5W), 0.68A (906 T5 wedge)
WT/DIMS	1.25 lbs. / 8.75" x 8.75" x 1.875"
WARRANTY	Three Year Warranty

69000201B DOME LIGHT

- 6-3/8" surface mount light with gray base
- Two-wire, replaceable 1142 bulb

BULK P/N	POLYPACK P/N	DESCRIPTION	QTY
DOMELIGHT			
69000201B	69000201P	Dome light, gray base	40
VOLT/AMP	12.8VDC - 1.44A (bulb 1142)		
WT/DIMS	.75 lb. / 6.25" x 6.25" x 2"		
WARRANTY	Three Year Warranty		



69000201B

69000300B DOME LIGHT

- 5-3/4" surface mount light with red and white bulbs
- Dual switch, frosted lens, white housing

BULK P/N	POLYPACK P/N	DESCRIPTION	QTY
DOMELIGHT			
69000300B	69000300P	Dome light, red/white bulbs	20
VOLT/AMP	12.8VDC - 1.00A (bulb 912)		
WT/DIMS	.48 lb. / 5.75" x 5.75" x 1.5"		
WARRANTY	Three Year Warranty		



69000300B

193 SERIES DOME LIGHTS

- Semi-recessed design with domed clear lens
- Replaceable bulb (1003 bayonet)

BULK P/N	POLYPACK P/N	DESCRIPTION	QTY
DOMELIGHT			
193BSP	193BSPP	Dome light, black	10
193G	193P	Dome light, gray	10
MATERIALS	Steel housing, polycarbonate lens		
VOLT/AMP	12.8VDC - 10.94A (bulb 1003 bayonet)		
WT/DIMS	.25 lb. / 5.75" x 2.688" x 1.5"		
WARRANTY	Three Year Warranty		



193BSP



193G



DOOR PULLS

- 11" door pulls with hinged end caps for easy installation
- Include steel reinforced mounting bases



01180071B
01180089B
01180090B

BULK P/N	POLYPACK P/N	DESCRIPTION	QTY
DOOR PULLS			
01180071B	01180071P	Black	25
01180089B	01180089P	Fawn	25
01180090B	01180090BP	Platinum silver	25

MATERIALS	Steel base, ABS handle
WT/DIMS	.18 lb. / 11" x 1.75" x 1"
WARRANTY	Three Year Warranty



SPRING LOADED HANDLES

Spring loaded handle, may also be used as a clothes hanger; choose from three colors



2500128B
2500171B
2500189B

BULK P/N	POLYPACK P/N	DESCRIPTION	QTY
HANDLES			
2500128B	2500128P	GM pewter	50
2500171B	2500171P	Black	50
2500189B	2500189P	Fawn	50

MATERIALS	ABS
WT/DIMS	.31 lb. / 8.75" x 1.125" x 3"
WARRANTY	Three Year Warranty

WALL PLATES

BULK P/N	POLYPACK P/N	DESCRIPTION	QTY
WALL PLATES / ACCESSORIES			
13000018B	13000018P	Standard 12V outlet, plastic	200
014BCRCW	014BCRCWP	Chrome 12V receptacle with cap	100
7850NFRC	7850NFRCP	Chrome 12V receptacle with cap & wires	250
RC	RCP	Rubber cap for 12V outlet	500



13000018B



RC

ASH TRAYS

BULK P/N	POLYPACK P/N	DESCRIPTION	QTY
ASH TRAYS			
520002B	520002P	Flush mount drop-in ashtray with snap-out inner tray, plastic	25
510001B	510001P	Drop-in ashtray	50
530002B	530002P	Round drop-in ashtray	40
500302B	500302P	Black lighter	25



520002B



530002B



500302B



510001B

RV ACCESSORIES



BEVERAGE HOLDERS



09017101B

- Versatile beverage holder for cups, cans and mugs
- Two-tier design includes a handle recess for cups and mugs, and rubber flaps to secure cans and smaller cups
- Black finish on all



3202B

302B

1502B



2409171B

BULK P/N	POLYPACK P/N	DESCRIPTION	QTY
CUP HOLDERS			
09017101B	09017101P	Dual purpose drop-in, handle cavity	50
3202B	3202P	3" two-tier drop-in	50
302B	302P	3" single tier drop-in	50
1502B	1502P	1.5" single tier drop-in	50
15202B	15202P	1.5" two-tier drop-in	50
2409171B	2409171BP	Adjustable, fold-down	100



REPLACEMENT BULBS - RV LIGHTING

BULK P/N	POLYPACK P/N	DESCRIPTION	QTY
BULBS			
30000000B	-	12" fluorescent, cool white	1
30031010B	-	18" fluorescent, cool white, Philips	24
30655010B	-	10W halogen	1

VEHICLE CONSPICUITY TAPE

- Alternating red/white pattern available in 11" red/7" white and 6" red/6" white patterns
- Solid white tape also available
- All tape is 2" wide, supplied in 150-ft rolls
- Choose from V92, V82 and V42 series tape
- Marked "DOT-C2" per NHTSA 9CFR571.108

BULK P/N	POLYPACK P/N	DESCRIPTION	QTY
V92 CONSPICUITY TAPE - 5 YEAR			
RTR15066B	RTR15066BP	6" red/6" white, continuous	1
RTR15066PB	RTR15066PBP	6" red/6" white, perforated	1
RTR150711B	RTR150711BP	11" red/7" white, continuous	1
RTR150711PB	RTR150711PBP	11" red/7" white, perforated	1
RT150WBD	RT150WBDP	Solid white, continuous	1
RETAIL			
RE418T		4-strip kit, 11" red/7" white	12
RE18T		8-strip kit, 11" red/7" white	12
RE21T		21-ft roll, 11" red/7" white	12

BULK P/N	POLYPACK P/N	DESCRIPTION	QTY
V82 CONSPICUITY TAPE - 10 YEAR			
RTR1015066CB	-	6" red/6" white, continuous	1
RTR10150711CB	-	11" red/7" white, continuous	1
RTR10150WB	-	Solid white, continuous	1

BULK P/N	POLYPACK P/N	DESCRIPTION	QTY
V42 CONSPICUITY TAPE - 3 YEAR			
RTR03150711CB	-	11" red/7" white, continuous	1

FMVSS	DOT-C2		
WARRANTY	V92:	Five Year Warranty	
	V82:	Ten Year Warranty	
	V42:	Three Year Warranty	

Reflexite®

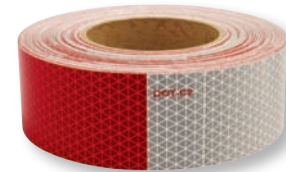

RTR150711B



RT150WBD



RE418T



RTR10150711CB



RTR10150WB



RTR03150711CB

CONSPICUITY TAPE

Reflexite®

SCHOOL BUS CONSPICUITY TAPE



RT150Y2DB

RT150Y1DB



RT150Y2B

RT150Y1B

- Yellow tape available in 1" and 2" widths
- All tape is supplied in 150-ft rolls
- Choose from V92 and V82 series tape
- Meets ASTM D4956-05 (Type V), FMVSS 131 & 217, CSA D250 requirements

BULK P/N	POLYPACK P/N	DESCRIPTION	QTY
V92 CONSPICUITY TAPE - 5 YEAR			
RT150Y1DB	RT150Y1DBP	1" yellow, diamond pattern	1
RT150Y2DB	RT150Y2DBP	2" yellow, diamond pattern	1

BULK P/N	POLYPACK P/N	DESCRIPTION	QTY
V82 CONSPICUITY TAPE - 10 YEAR			
RT150Y1B	RT150Y1BP	1" yellow	1
RT150Y2B	RT150Y2BP	2" yellow	1

FMVSS	ASTM D4956-05 (Type V), FMVSS 131 & 217, CSA D250		
WARRANTY	V92:	Five Year Warranty	
	V82:	Ten Year Warranty	

Reflexite®

VEHICLE CONSPICUITY TAPE

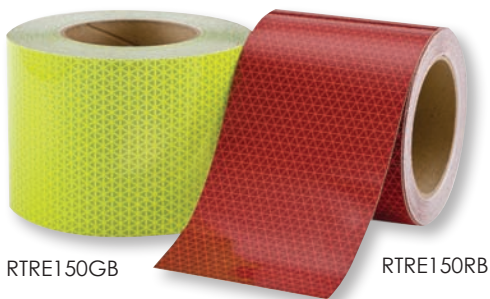

RTRE150GB

RTRE150RB

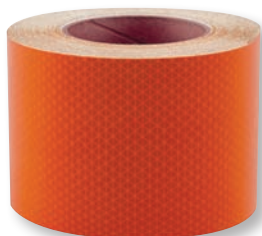

RTRE150OB

- Conformable sheeting for emergency vehicles
- Supplied in 6" wide, 150-ft rolls
- Choose from fluorescent lime, red and orange (other colors available upon request)
- Use red/lime sheeting to meet fire apparatus regulation NFPA 1901

BULK P/N	POLYPACK P/N	DESCRIPTION	QTY
V98 CONFORMABLE SHEETING			
RTRE150RB	-	6" red, diamond pattern	1
RTRE150GB	-	6" lime, diamond pattern	1
RTRE150OB	-	6" orange, diamond pattern	1

FMVSS	NFPA 1901		
WARRANTY	Red/Orange:	Five Year Warranty	
	Lime:	Three Year Warranty	

RECTANGULAR REFLECTORS

- Select from multiple shapes, sizes and mounting methods; available in bulk, polypack and retail clams
- Acrylic construction; meet FMVSS "A" for reflex when properly applied

BULK P/N	POLYPACK P/N	DESCRIPTION	QTY
REFLECTORS			
RE10AB	RE10ABP	Rectangular, yellow, self adhesive	100
RE10RB	RE10RBP	Rectangular, red, self adhesive	100
RE11AB	RE11ABP	Oblong, yellow, self adhesive/screw mount	100
RE11RB	RE11RBP	Oblong, red, self adhesive/screw mount	100
RE15AB	RE15ABP	Thinline, yellow, adhesive/screw mount	100
RE15RB	RE15RBP	Thinline, red, adhesive/screw mount	100
RETAIL - CLAM			
RE10AK		Rectangular, yellow, self adhesive	12
RE10RK		Rectangular, red, self adhesive	12
RE12AK		Oblong, yellow, self adhesive/screw mount	12
RE12RK		Oblong, red, self adhesive/screw mount	12
RE12ARK		(2) each yellow and red RE12	12
RE15AK		Thinline, yellow, adhesive/screw mount	12
RE15RK		Thinline, red, adhesive/screw mount	12
RE52ARK		(2) each yellow and red RE52	12

FMVSS	A
MATERIALS	Acrylic
WARRANTY	Three Year Warranty

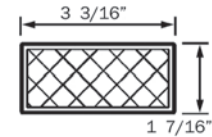
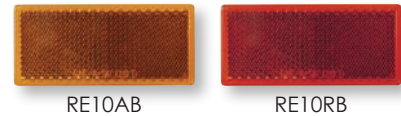

RE11RB
RE12RK

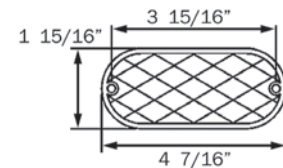

RE15RB

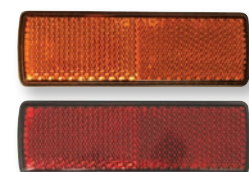
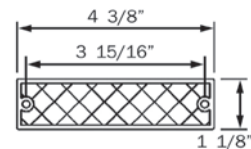

RE52ARK

4" W X 1.25" H X 0.75" D

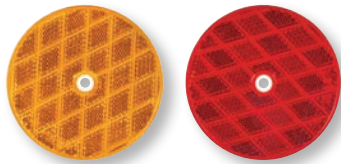

RE13AB RE13RB

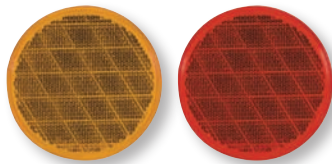
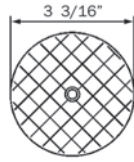

RE21AB RE21RB

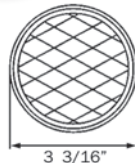

RE31AS RE31RS

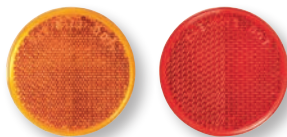
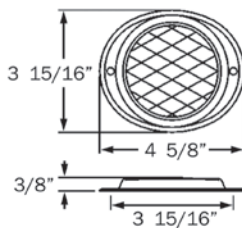

RE37AB RE37RB

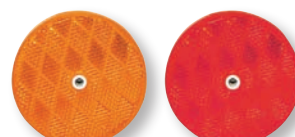
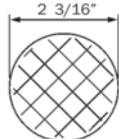

RE35AB RE35RB

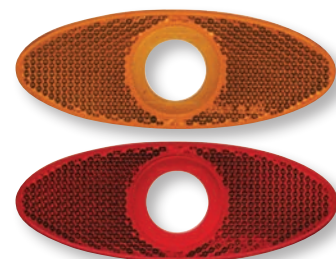
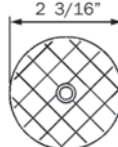

A11AXB / A11RXB

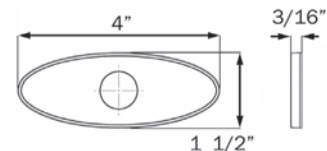

ROUND & OVAL REFLECTORS

- Select from multiple shapes, sizes and mounting methods; available in bulk, polypack and retail clams
- Acrylic construction; meet FMVSS "A" for reflex when properly applied

BULK P/N	POLYPACK P/N	DESCRIPTION	QTY
----------	--------------	-------------	-----

REFLECTORS			
A11AXB	A11AXBP	Yellow reflector for 3/4" lights, self adhesive	100
A11RXB	A11RXP	Red reflector for 3/4" lights, self adhesive	100
RE13AB	RE13ABP	3" round, yellow, center mount	50
RE13RB	RE13RBP	3" round, red, center mount	50
RE21AB	RE21ABP	3" round, yellow, self adhesive	50
RE21RB	RE21RBP	3" round, red, self adhesive	50
RE35AB	RE35ABP	2" round, yellow, center mount	100
RE35RB	RE35RBP	2" round, red, center mount	100
RE37AB	RE37ABP	2" round, yellow, self adhesive	100
RE37RB	RE37RBP	2" round, red, self adhesive	100

RETAIL - CLAM			
RE21AS		3" round, yellow, self adhesive	12
RE21RS		3" round, red, self adhesive	12
RE31AS		3" armored aluminum, yellow, screw mount	12
RE31RS		3" armored aluminum, red, screw mount	12

FMVSS	A
MATERIALS	Acrylic
WARRANTY	Three Year Warranty

3/4" GROMMETS & BRACKETS

Grommets and Brackets for 3/4" Round Sealed Lights

- PVC grommets for flush mount of 3/4" round lights
- Snap-in mounting flange for secure installation
- Stainless steel trim ring covers grommet
- License plate light brackets for use with LPL12CB
- **New!** Reflectors for marker/clearance lights

BULK P/N	POLYPACK P/N	DESCRIPTION	QTY
GROMMETS & BRACKETS			
A11GB	A11GBP	Standard grommet	100
A12GB	A12GBP	Sealing grommet, for material thickness .070-.125"	100
A14GB	A14GBP	Sealing grommet, for material thickness .1250-.250"	100
A11PB	A11PBP	Snap-in mounting flange	100
A11SRB	A11SRBP	Locking nut; use with A11PB	100
REFLECTORS/TRIM RINGS			
A11AXB	A11AXBP	Yellow reflector, self adhesive	100
A11RXB	A11RXBP	Red reflector, self adhesive	100
A11SSB	A11SSBP	Stainless steel trim ring	100
LICENSE PLATE LIGHT BRACKETS/ACCESSORIES			
A11GLPB	A11GLPBP	License light bracket, gray	50
A11BLPB	A11BLPBP	License light bracket, black	50
A12B2LPB	A12B2LPBP	Vertical license light bracket	50
A12GLPB	A12GLPBP	Grommet for A12B2LPB bracket	50
P/N	MATERIALS	WT/DIMS	
A11GB	PVC	.05 lb. / 1.083" x 1.083" x 0.456"	
A12GB	PVC	.05 lb. / 1.094" x 1.094" x 0.465"	
A14GB	PVC	.05 lb. / 1.094" x 1.094" x 0.465"	
A11PB	Polycarbonate	.05 lb. / 1.156" x 1.156" x 0.75"	
A11SSB	Stainless steel	.05 lb. / 1.313" x 1.313" x 0.125"	
A11GLPB	Polycarbonate	.08 lb. / 2.25" x 1.375" x 0.625"	
A12GLPB	Polycarbonate	.12 lb. / 3.438" x 2.688" x 2.313"	
A11AXB/RXB	Acrylic	.05 lb. / 4" x 1.5" x 0.188"	



A11GB

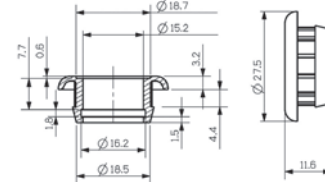

HOLE CUT-OUT: 0.75"



A11PB

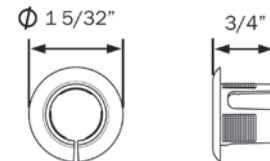

HOLE CUT-OUT: 0.75"



A11SRB
Use with A11PB



A11GLPB

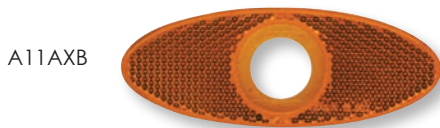

A11SSB



A12B2LPB bracket shown with light and A12GLPB grommet



A54GB

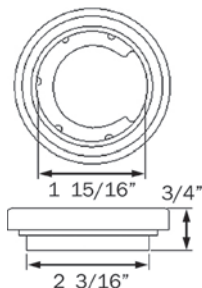

HOLE CUT-OUT: 2.313"



A46PB

2" GROMMETS & ACCESSORIES

Grommets, Mounting Brackets and Trim Rings for 2" Round Lights

- PVC grommet for flush mount of 2" round lights provides shock mount to lengthen bulb life
- Choice of two surface mount brackets
- Trim rings for grommet or flange mount lights, screw mount

BULK P/N	POLYPACK P/N	DESCRIPTION	QTY
MOUNTING ACCESSORIES			
A54GB	A54GBP	Flush mount grommet	100
A54GK	A54GKP	Kit: A54GB & A46PB PL-10 plug	100
BK5557GB	BK5557GBP	Cam-on mounting bracket	50
A55CB	A55CBP	Chrome trim ring, grommet mount	20
A3TRSSB	A3TRSSBP	Stainless steel trim ring, flange mount	100
BK53BB	BK53BBP	Branch deflector bracket, gray	50
WIRING ACCESSORIES			
A46PB	A46PBP	Two-pin plug with 6" lead, #10 terminal on ground	50

P/N	MATERIALS	WT/DIMS
A54GB	PVC	.05 lb. / 2.625" x 2.625" x 0.75"
BK5557GB	ABS	.05 lb. / 4" x 2.125" x 1"
A55CB	ABS	.05 lb. / 3.25" x 3.25" x 0.438"
A3TRSSB	Stainless steel	.05 lb. / 3.063" x 3.063" x 0.125"
BK53BB	ABS	.05 lb. / 5.375" x 2.75"



A55CB



A3TRSSB



BK5557GB



BK53BB

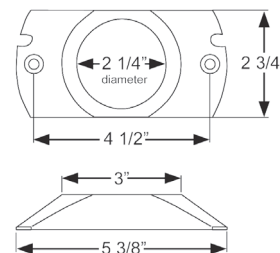
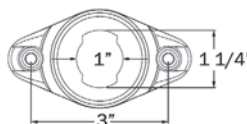
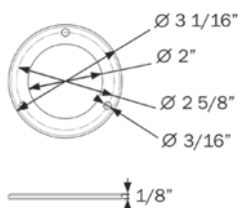
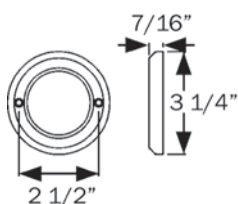

2.5" GROMMETS

Mounting Grommets for 2.5" Round Sealed Lights

- PVC grommets for flush mount of 2.5" round lights
- Grommet provides shock mount to lengthen bulb life

BULK P/N	POLYPACK P/N	DESCRIPTION	QTY
MOUNTING ACCESSORIES			
A55GB	A55GBP	Open back, flush mount, black	50
A55GK	A55GKP	Kit: A55GB & A46PB PL-10 plug	100
A55GWB	-	Open back, flush mount, white	50
A56GB	A56GBP	Closed back, recess mount, black	100
A57GB	A57GBP	Open back, recess mount, black	50
A57GK	A57GKP	Kit: A57GB & A46PB PL-10 plug	100
A58GB	A58GBP	Angled grommet, black	100

WIRING ACCESSORIES			
A46PB	A46PBP	PL-10 plug with 6" lead, #10 terminal on ground	100

P/N	MATERIALS	WT/DIMS
A55GB/GWB	PVC	.132 lb. / 3.5" x 3.5" x .938"
A56GB	PVC	.132 lb. / 3.25" x 3.25" x 1.125"
A57GB	PVC	.11 lb. / 3.25" x 3.25" x 1.125"
A58GB	PVC	.132 lb. / 3.438" x 3.438" x 0.875"



A55GB

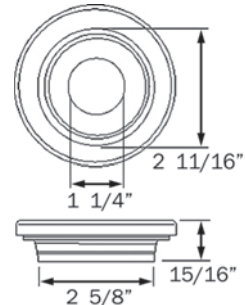

HOLE CUT-OUT: 3"



A56GB

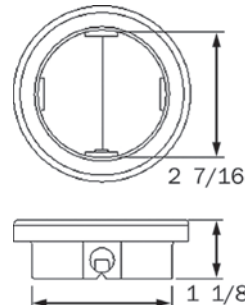

HOLE CUT-OUT: 2.75"



A57GB

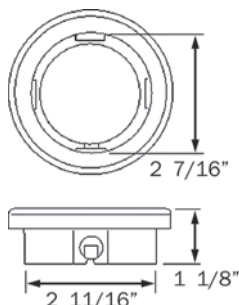

HOLE CUT-OUT: 2.75"



A58GB

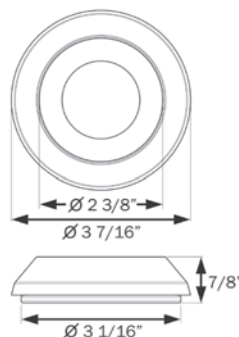

HOLE CUT-OUT: 2.75"

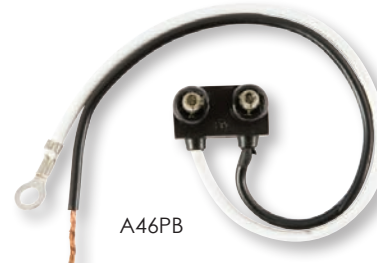

A46PB



BK55BB

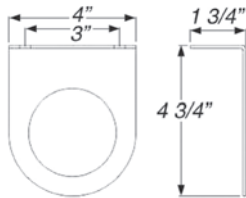

BK57BB

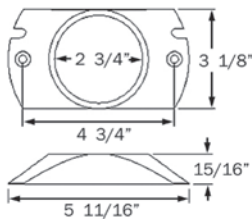

A25TRSSB

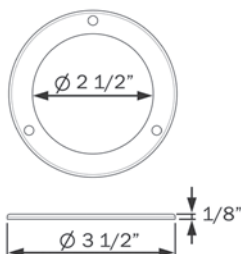

A57CB

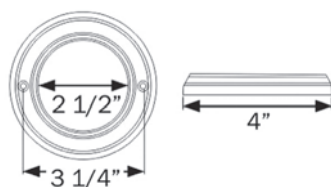

BK5557GB

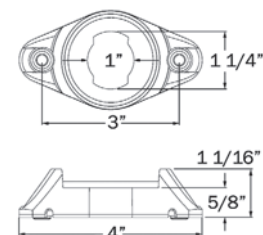

2.5" BRACKETS & TRIM RINGS

Mounting Brackets and Ornamental Trim Rings for 2.5" Round Sealed Lights

- Choice of three brackets for surface mount of 2.5" round sealed lights
- Trim rings for grommet or flange mount lights, screw mount

BULK P/N	POLYPACK P/N	DESCRIPTION	QTY
MOUNTING ACCESSORIES			
BK55BB	BK55BBP	Black steel bracket for use with grommet; no cut-out in trailer frame required	20
BK57BB	BK57BBP	Surface mount branch deflector bracket, gray plastic	50
BK5557GB	BK5557GBP	Cam-on mounting bracket with built-in branch deflector, suitable for use with PC rated lights	50
A25TRSSB	A25TRSSBP	Stainless steel trim ring, flange mount	50
A57CB	A57CBP	Chrome trim ring, grommet mount	20

P/N	MATERIALS	WT/DIMS
BK55BB	Steel	.375 lb. / 4" x 4.75" x 1.75"
BK57BB	Polycarbonate	.066 lb. / 5.688" x 3.125" x 0.938"
BK5557GB	Plastic	.066 lb. / 4" x 2.125" x 1"
A25TRSSB	Stainless steel	.04 lb. / 3.5" x 3.5" x 0.125"
A57CB	Plastic	.11 lb. / 4" x 4" x 0.415"

MC65 SERIES BRACKETS

Mounting Brackets for MCL61 & MC/MCL65 Series Lights

- Corrosion proof brackets for surface mount of 61/65 series lights
- Single wire design grounds through mounting hardware
- Two-wire design includes both lead and ground wires

BULK P/N	POLYPACK P/N	DESCRIPTION	QTY
SURFACE MOUNT BRACKETS			
A65B	A65BP	Black bracket only	50
A65PB	A65PBP	Kit: A65B & A65P single wire plug	50
A65PBPG	-	Kit: A65B & A65P single wire plug with .180 molded male bullet	50
A65TB	-	Black bracket only, thick base	50
A66PB	A66PBP	Kit: Gray bracket & A65P single wire plug	50
A67CB	A67CBP	Kit: Chrome bracket & A65P, 12" lead	50
A67CBPG	-	Kit: Chrome bracket & single wire plug with .180 molded male bullet, 18" lead	50
A67P10G	-	Kit: Chrome bracket & single wire plug with .180 molded male bullet, 10" lead	100
A68PB	A68PBP	Kit: A65B & A68P two-wire plug	50
A65PRXB	-	Kit: Black bracket with red reflector installed & single wire plug	50
WIRING ACCESSORIES			
A65P	A65PP	One-wire plug, grounds through mounting hardware	50
A68P	-	Two-wire plug, includes lead and ground	50

P/N	MATERIALS	WT/DIMS
A65/67 brackets	Plastic	.044 lb. / 4.063" x 1.063" x 0.5"
A65PRXB	Plastic/Acrylic	.088 lb. / 4" x 2.438" x 0.5"

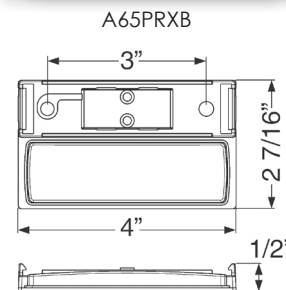
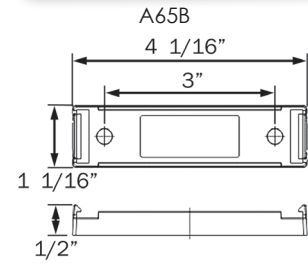

A65P



A68P



A67BB

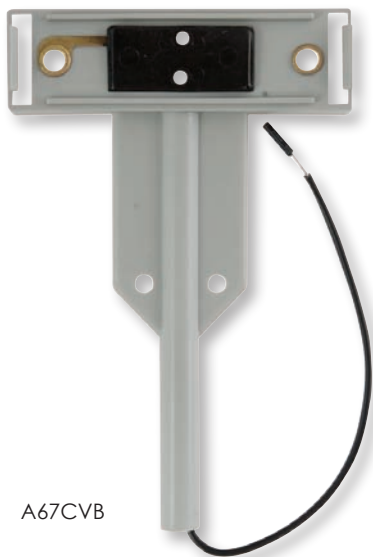

A67CVB

A67 SERIES BRACKETS

Mounting Brackets for Thinline Fender Lights

- Corrosion proof brackets for surface mount of 61/65 series fender lights
- Single wire design grounds through mounting hardware
- For use in exterior (top) fender applications with MC65ARB, MCL61ARB and MCL65ARB

BULK P/N	POLYPACK P/N	DESCRIPTION	QTY
----------	--------------	-------------	-----

SURFACE MOUNT FENDER BRACKETS

A67BB	A67BBP	Black fender bracket with self grounding, single wire plug	50
A67GB	A67GBP	Gray fender bracket with self grounding, single wire plug	50
A67CVB	A67CVBP	Curved gray fender bracket with self grounding, single wire plug; curved to fit radius of trailer fender	50

P/N	MATERIALS	WT/DIMS
A67BB/GB brackets	ABS	.066 lb. / 6.125" x 4.125" x 0.625"

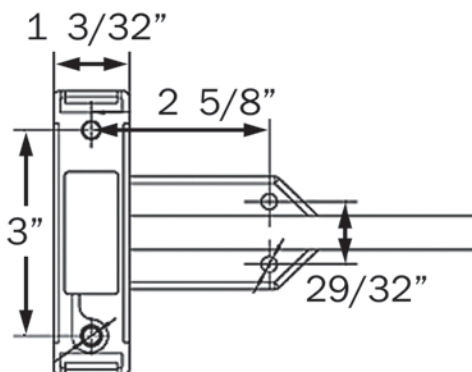

91 SERIES GROMMETS

Mounting Grommets for A91, AL90, AL191 and AL91 Series Lights

- PVC grommets for flush mount of 90/91 series lights
- Provide shock mount to lengthen life of light
- A91G15B1 allows light to be mounted at 15 degrees

BULK P/N	POLYPACK P/N	DESCRIPTION	QTY
GROMMETS			
A91GB	A91GBP	Black grommet, flush mount	100
A91GOB	A91GOBP	Black open back grommet	100
A91G15B1	A91G15B1P	Black 15 degree angled grommet	100
A91GZB	-	Black vertical mount grommet	50
WIRING ACCESSORIES			
A46PB	A46PBP	Two-wire plug, standard PL-10 connector	100

P/N	MATERIALS	WT/DIMS
A91GB/GOB	PVC	.066 lb. / 3.313" x 1.938" x 0.5"
A91G15B1	PVC	.066 lb. / 3.313" x 1.938" x 1.313"



A91GB

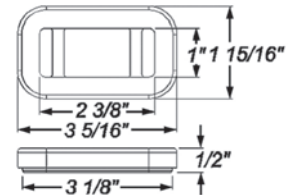

A91G15B1

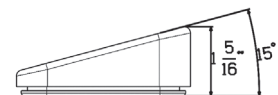
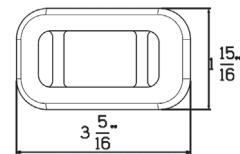

A46PB



A91CB

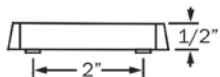
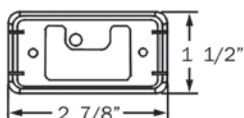

A91BB/CB



A91BOB

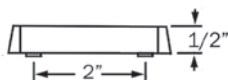
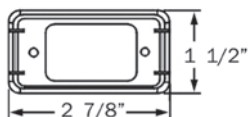

A91BOB/OB

91 SERIES BRACKETS

Mounting Brackets for A91, AL90, AL191 and AL91 Series Lights

- Corrosion proof brackets for surface mount of 90/91 series lights
- Self grounding bases ground through mounting hardware and should be used with A91LW plug
- Open back bases should be used with A46PB two-wire plug

BULK P/N	POLYPACK P/N	DESCRIPTION	QTY
SURFACE MOUNT BRACKETS			
A91BB	A91BBP	Black base, self grounding	100
A91BOB	A91BOBP	Black base, open back	100
A91CB	A91CBP	Chrome base, self grounding	100
A91OB	A91OBP	Chrome base, open back	100
A82BB	A82BBP	Black base, open back; use with A90CB	50
A82CRB	A82CRBP	Chrome elevated base, open back	50
A90CB	-	Chrome snap-on cover for A82BB	50
WIRING ACCESSORIES			
A91LW	A91LWP	Single wire plug, molded male bullet	100
A46PB	A46PBP	Two-wire plug, standard PL-10 connector	100

P/N	MATERIALS
All Brackets	Plastic



A82CRB

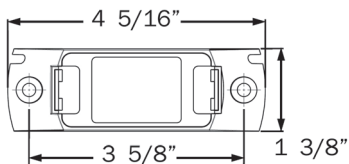

A90CB

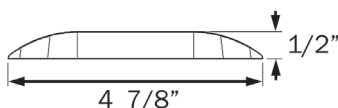
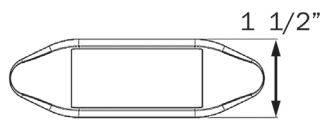

A82BB

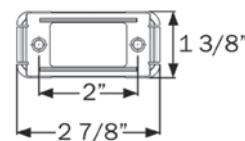

4" ROUND GROMMETS & BRACKETS

Mounting Grommets & Brackets for Sealed 4" Round Lights

- PVC grommets for flush mount of 45 series lights; grommet provides shock mount to lengthen life of light
- Mounting flanges for flush mount of 45 series lights; lights snap into flange
- Steel bracket mounts to trailer frame; no panel cutout required. Use with A45GB grommet. Durable powder coated finish.

BULK P/N	POLYPACK P/N	DESCRIPTION	QTY
GROMMETS			
A45GB	A45GBP	PVC grommet, flush mount	50
BRACKETS			
A45BB	A45BBP	Black plastic mounting flange	100
A45SB	A45SBP	Stainless steel mounting flange	20
BK45BB	BK45BBP	Steel mounting bracket, powder coated	10

P/N	MATERIALS	WT/DIMS
A45GB	PVC	.176 lb. / 5.375" x 5.375" x 1.063"
A45BB	Plastic	.11 lb. / 5.5" x 5.5" x 1"
A45SB	Stainless steel	.19 lb. / 5.563" x 5.563" x 0.75"
BK45BB	Steel	.794 lb. / 6" x 5.813" x 1.375"



A45GB

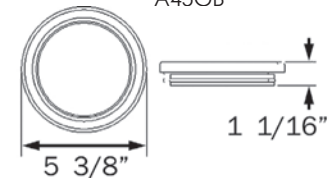

HOLE CUT-OUT: 4.5"



A45BB

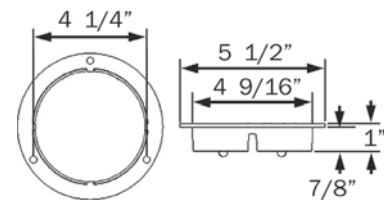

BK45BB

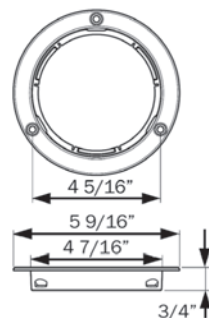
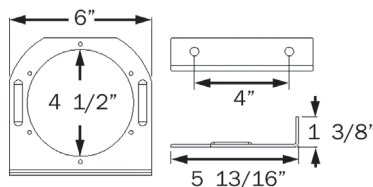

A45SB

4" ROUND TRIM RINGS

Trim Rings for Sealed 4" Round Lights



A5TRSSB / A42FCB

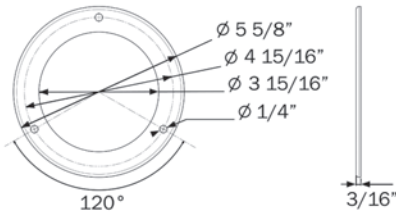

- Stainless steel models fit flange mount lights
- Chrome-plated plastic model fits grommet mount lights
- Trim rings mount using screws

BULK P/N	POLYPACK P/N	DESCRIPTION	QTY
TRIM RINGS			
A5TRSSB	A5TRSSBP	Stainless steel trim ring for flange mount lights	100
A42FCB	A42FCBP	Chromed metal trim ring for flange mount lights	100
A45CGB	A45CGBP	Chrome-plated plastic trim ring for grommet mount lights	20
A101TRSSB	A101TRSSBP	Stainless steel trim ring for STL/BUL101 flange mount lights	50



A45CGB

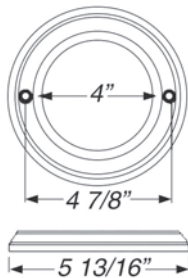

P/N	MATERIALS	WT/DIMS
A5TRSSB	Stainless steel	.132 lb. / 5.625" x 5.625" x 0.188"
A42FCB	Metal, chrome	.132 lb. / 5.625" x 5.625" x 0.188"
A45CGB	Plastic	.132 lb. / 5.813" x 5.813" x 0.5"
A101TRSSB	Stainless steel	.132 lb. / 5.625" x 5.625" x 0.188"



A101TRSSB

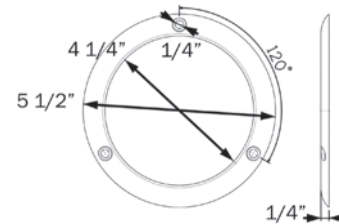

6" OVAL GROMMETS/BRACKETS

Mounting Grommets & Brackets for Sealed 6" Oval Lights

- PVC grommets for flush mount of 70 series lights; grommet provides shock mount to lengthen life of light
- Steel brackets mount to trailer frame; no panel cutout required. Use with A70GB grommet or recess flange mount lights.

BULK P/N	POLYPACK P/N	DESCRIPTION	QTY
GROMMETS			
A70GB	A70GBP	PVC grommet, flush mount	50
BRACKETS			
BK70BB	BK70BBP	Steel mounting bracket, powder coated	10
A77SB	A77SBP	Steel mounting bracket, gray	20

P/N	MATERIALS	WT/DIMS
A70GB	PVC	.132 lb. / 7.625" x 3.375" x 1.125"
BK70BB	Steel	.728 lb. / 8.25" x 4" x 1.625"
A77SB	Steel	.132 lb. / 8.25" x 5.75" x 1.375"



A70GB

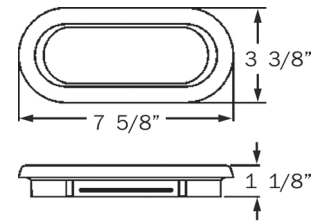

HOLE CUT-OUT: 6.85" x 2.5" (1.25" R)



BK70BB

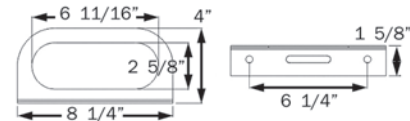

A77SB

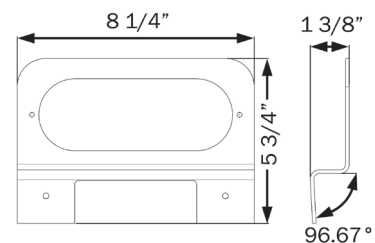



A7TRSSB

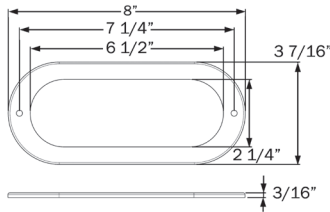

6" OVAL FLANGE COVERS

Trim Rings for 6" Oval Sealed Flange Mount Lights

- Choose from stainless steel, chrome-plated plastic and red reflex models
- A7TRSSB mounts to STL75AMFB flange using screws
- A78CB1 and A78RXB snap onto flange/surface mount lights
- A78RXB fulfills rear reflex function, eliminating the need for a separate reflector



A78CB1

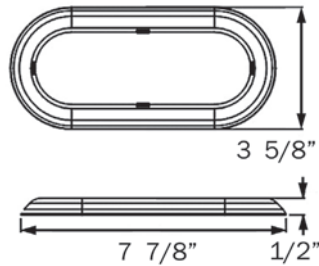

A78RXB

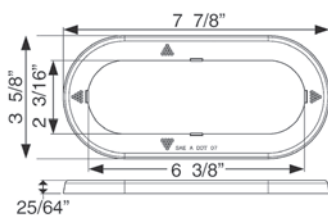

BULK P/N	POLYPACK P/N	DESCRIPTION	QTY
FLANGE COVERS			
A7TRSSB	A7TRSSBP	Stainless steel, screw mount (STL75AMFB)	100
A78CB1	A78CB1P	Chrome-plated plastic, snap-on	25
A78RXB	A78RXBP	Red reflex, snap-on	25
A111TRSSB	A111TRSSBP	Stainless steel screw mount trim ring for STL/BUL111 flange mount lights	50
A178TRSSB	A178TRSSBP	Stainless steel screw mount trim ring for STL178 flange mount lights	50

P/N	MATERIALS	WT/DIMS
A7TRSSB	Stainless steel	.066 lb. / 8" x 3.438" x 0.188"
A78CB1	ABS Plastic	.066 lb. / 7.875" x 3.625" x 0.5"
A78RXB	Acrylic	.066 lb. / 7.875" x 3.625" x 0.391"
A111TRSSB	Stainless steel	.066 lb. / 7.625" x 3.25" x 0.25"
A178TRSSB	Stainless steel	.066 lb. / 7.563" x 3.313" x 0.188"



A111TRSSB

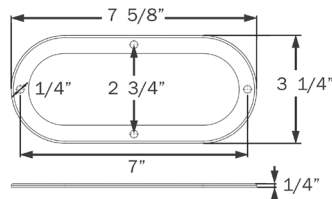

A178TRSSB

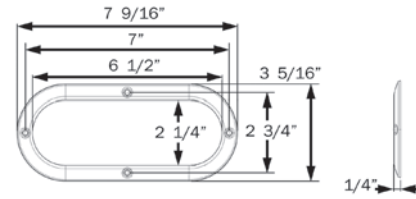

MOUNTING ACCESSORIES

Miscellaneous Mounting Grommets, Brackets & Accessories

- A33GB is PVC grommet for flush mount of 33/35 series lights; grommet provides shock mount to lengthen life of light
- BK42CB offers added protection for oblong, surface mount marker lights
- BK66DB offers added protection for MCL66 series lights
- A40SRB secures lens of ST series lights

BULK P/N	POLYPACK P/N	DESCRIPTION	QTY
GROMMET - ST/STL33 SERIES			
A33GB	A33GBP	PVC grommet, flush mount	50
BRACKET - OBLONG M/C LIGHTS			
BK42CB	BK42CBP	Steel mounting bracket, chrome plated	100
BRACKET - MCL66 SERIES			
BK66DB	BK66DBP	Heavy duty armored base for MCL66 series lights; die cast metal	50
RETENTION RING - ST40 SERIES			
A40SRB	A40SRBP	Snap ring for ST40 series lights	100

P/N	MATERIALS	WT/DIMS
A33GB	PVC	.353 lb. / 6.25" x 4.125" x 1.625"
BK42CB	Steel	.243 lb. / 5.438" x 2.375" x 1.125"
BK66DB	Aluminum	.132 lb. / 4.25" x 1.125" x 1.688"
A40SRB	Metal	.066 lb. / 5.125" x 0.125"



A33GB

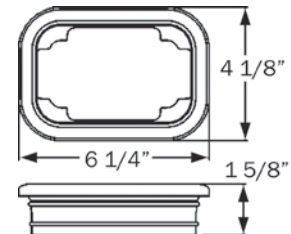

HOLE CUT-OUT: 5.453" x 3.578" (1" R)

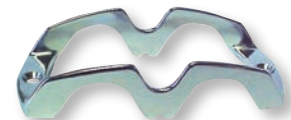

BK42CB

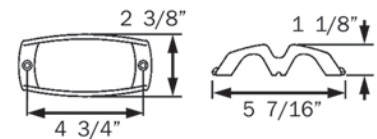

BK66DB

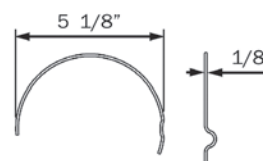
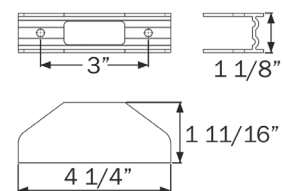

A40SRB



A13C2B



A13B2B

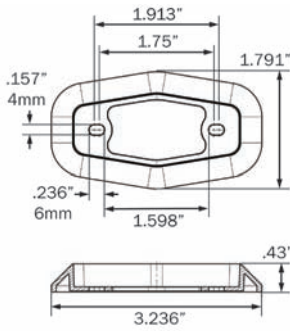

A15CB

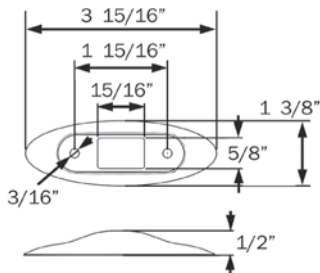

A48CB



A69CB



A79CB

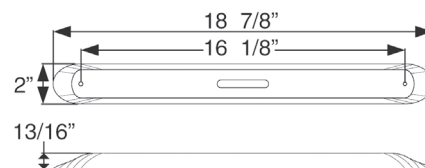
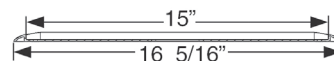
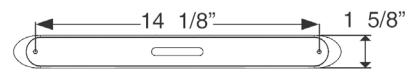

MOUNTING ACCESSORIES

Miscellaneous Mounting Bases & Bezels

- Chrome finish plastic mounting bases/bezels available for several light series; see details below
- Chrome finish plastic bezel for MCL48 and MCL73 dresses up light and covers mounting holes

BULK P/N	POLYPACK P/N	DESCRIPTION	QTY
BASES/BEZELS			
A09BB	A09BBP	UCL09 trim ring, black	50
A09CB	A09CBP	UCL09 trim ring, chrome	50
A09WB	A09BBP	UCL09 trim ring, white	50
A13C2B	A13C2BP	MCL/UCL13 base/bezel, chrome	100
A13B2B	A13B2BP	MCL/UCL13 base/bezel, black	100
A15BB	A15BBP	MCL15 base/bezel, black	100
A15CB	A15CBP	MCL15 base/bezel, chrome	100
A21CHB	A21CHBP	ILL21 bezel, chrome	25
A21WB	A21WBP	ILL21 bezel, white	25
A48CB	A48CBP	MCL48 & MCL73 bezel, chrome	50
A69CB	A69CBP	STL69 & MCL70 base/bezel, chrome	10
A69RXC	A69RXCBP	STL69RRXB base/bezel, chrome	10
A79CB	-	MCL78/88 and STL79/80/89/90 series base/bezel, chrome	10

P/N	MATERIALS	WT/DIMS
A09BB/CB/WB	ABS	.06 lb. / 3.421" x 3.421" x .287"
A13C2B/B2B	ABS	.088 lb. / 3.236" x 1.791" x .43"
A15BB/CB	ABS	.088 lb. / 3.938" x 1.374" x .5"
A21CHB/WB	ABS	.088 lb. / 6.313" x 6.313" x .563"
A48CB	ABS	.088 lb. / 6" x 2.25" x 1.125"
A69CB	ABS	.176 lb. / 16.313" x 1.625" x 0.813"
A69RXC	ABS	.176 lb. / 16.313" x 1.875" x 0.813"
A79CB	ABS	.176 lb. / 18.875" x 2" x 0.813"

LICENSE PLATE BRACKETS

- Select from heavy duty metal and corrosion proof plastic
- Accept stud mount license plate lights

BULK P/N	POLYPACK P/N	DESCRIPTION	QTY
BRACKETS			
LP5SB	LP5SBP	Black heavy duty plastic	100
LP10SB	LP10SBP	Black heavy duty plastic	50
LP15SB	LP15SBP	Zinc plated steel	12
LP20SB	LP20SBP	Powder coated steel	25
LP31SB	LP31SBP	Black heavy duty plastic for low temps	50
BK31BB	BK31BBP	Black heavy duty plastic	50
RETAIL			
LP10S		Black heavy duty plastic, clam	12
LP15S		Zinc plated steel, clam	12

P/N	MATERIALS	WT/DIMS
LP5SB	Plastic	.17 lb. / 8.25" x 4.25" x .813"
LP10SB	Plastic	.17 lb. / 9.5" x 4.813"
LP15SB	Steel	.397 lb. / 8.438" x 3.625" x 1.5"
LP20SB	Steel	.132 lb. / 8.5" x 2.875"
LP31SB	Plastic - low temp	.17 lb. / 8.25" x 4.25" x .813"
BK31BB	Plastic	.17 lb. / 8.25" x 4.25" x .813"



LP5SB

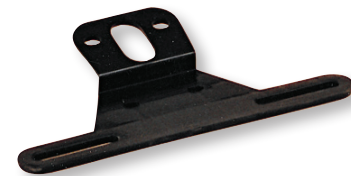
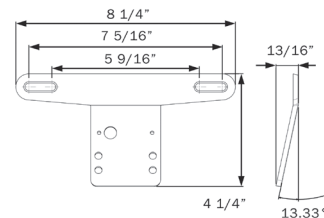

LP10SB

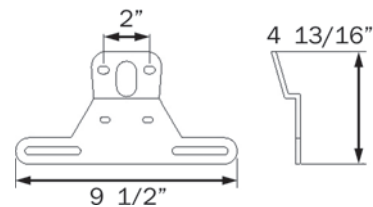

BK31BB
LP31SB

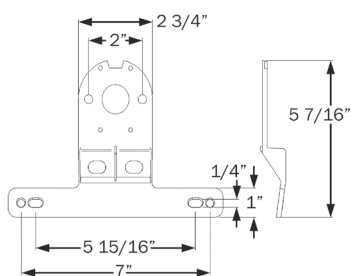

LP20SB

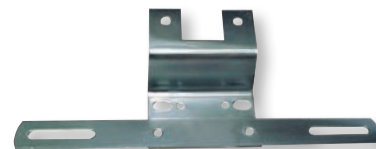
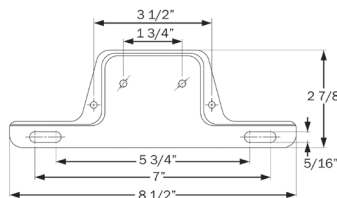

LP15SB

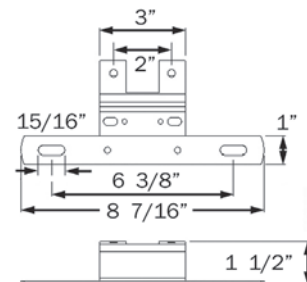



LP25SB

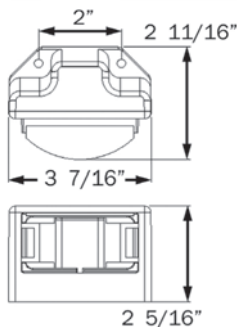

LP35BB

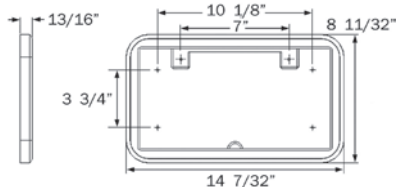

LICENSE LIGHT BRACKETS & LICENSE PLATE HOLDER

- LP25SB surface mount bracket accepts LP91 and LPL91 series lights; mounting gasket sold separately
- LP35BB surface mount license plate holder is designed for mounting on flat surfaces

BULK P/N	POLYPACK P/N	DESCRIPTION	QTY
LICENSE LIGHT BRACKETS			
LP25SB	LP25SBP	Black bracket for LP/LPL91 lights	100
LP25SGGB	LP25SGGBP	Gray bracket for LP/LPL91 lights	100
A25GB	A25GBP	Gasket for LP25SB	100
LICENSE PLATE HOLDER			
LP35BB	LP35BBP	Black license plate holder	25

P/N	MATERIALS	WT/DIMS
LP25SB/GGB	Polycarbonate	.066 lb. / 3.438" x 2.688" x 2.313"
LP35BB	Plastic	.122 lb. / 14.5" x 8.25"

DOCUMENT HOLDER

- Twist-on cover with gasket protects documents from dirt and moisture while allowing convenient access
- Easy installation



DH55

BULK P/N	POLYPACK P/N	DESCRIPTION	QTY
DOCUMENT HOLDER			
DH55	DH55P	Document holder	10

P/N	MATERIALS	WT/DIMS
DH55	Polycarbonate	0.46 lb. / 5.5" x 5.5" x 2.125"

3-WIRE PIGTAILS

Wiring/Molded Plugs for Double Contact Sealed Lights

- A45PB & A47PB feature standard PL-3 plug with male pins, bare lead wires and #10 ring terminal on ground wire
- For use with stop/turn/tail, parking/turn and warning lights

BULK P/N	POLYPACK P/N	DESCRIPTION	QTY
STANDARD PL-3			
A45PB	A45BPB	Straight pigtail, 6"	100
A47PB	A47BPB	Right angle pigtail, 10"	100
WEATHERPROOF			
A45PMB	A45PMBP	Weathertight plug to bare wire, 10"	50
AL45PWTB	AL45PWTBP	Weathertight plug with female PL-3, 10"	50
RETAIL			
A45PS		Straight pigtail, 6", clam	50
A47PS		Right angle pigtail, 10", clam	50

WT All weigh approximately 0.044 lb. each

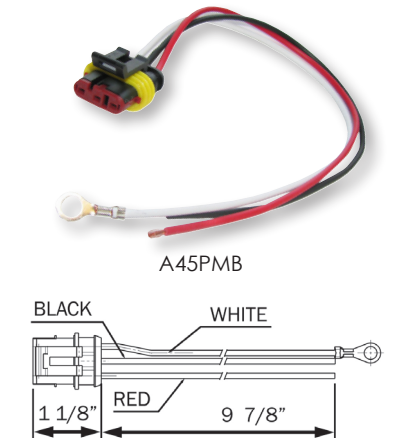
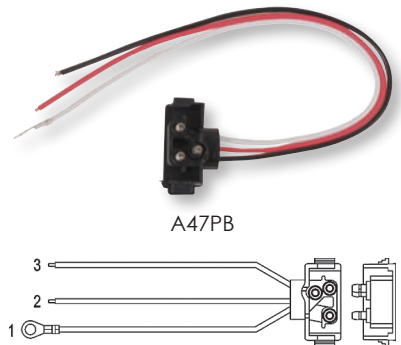
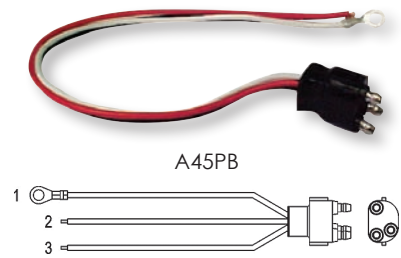



A45CB

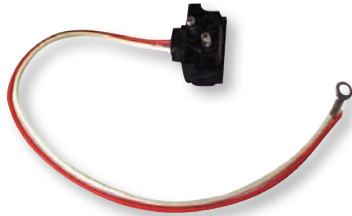
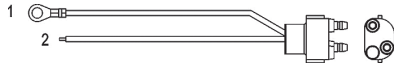

A49PB

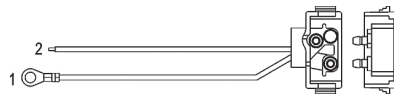

2-WIRE PIGTAILS

Wiring/Molded Plugs for Single Contact Sealed Lights

- Standard two terminal plug with male pins, bare lead wire and #10 ring terminal on ground wire
- For use with back-up and utility lights

BULK P/N	POLYPACK P/N	DESCRIPTION	QTY
TWO-WIRE PIGTAILS			
A45CB	A45CBP	Straight pigtail, 10"	100
A49PB	A49BPB	Right angle pigtail, 10"	100
WT	All weigh approximately 0.044 lb. each		

2-WIRE PIGTAILS

Wiring/Molded Plugs for Sealed Marker/Clearance & Utility Lights

- Pigtails feature standard PL-10 plug with male pins; bare lead wires and #10 ring terminal on ground wire unless noted in description
- For use with sealed marker/clearance and utility lights



A46PB

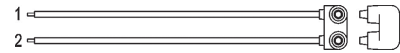

BULK P/N	POLYPACK P/N	DESCRIPTION	QTY
TWO-WIRE PL-10 PLUGS			
A46PB	A46PBP	Straight pigtail, 6"	100
A46PPG	A46PPGP	Straight pigtail, 6", male plug on power	100
A46P135B	-	Straight pigtail, 135", no ring terminal on ground wire	100
A46P75B	-	Straight pigtail, 75", no ring terminal on ground wire	100
A46P36B	-	Straight pigtail, 36", no ring terminal on ground wire	100
A86PB	A86PBP	Straight pigtail, 18"	100
RETAIL			
A46PS		Straight pigtail, 6", clam	12

WT All weigh approximately 0.044 lb. each

ID LIGHT BAR HARNESS

Wiring/Molded Plugs for 3-Pc Sealed Identification Light Bars

- Standard two terminal plugs with male pins; 65" bare lead wire and #10 ring terminal on 19" ground wire
- For use with identification light bars featuring sealed lights



A93PB

BULK P/N	POLYPACK P/N	DESCRIPTION	QTY
ID LIGHT BAR HARNESS			
A93PB	A93PBP	ID light bar harness	100

WT 0.4 lb.



A91LW



SINGLE WIRE PLUG

Wiring/Molded Plug for Marker/Clearance & Utility Lights

- Standard molded .180 male plug with 12" lead wire
- For use with sealed marker/clearance and utility lights installed in self-grounding base

BULK P/N	POLYPACK P/N	DESCRIPTION	QTY
SINGLE WIRE PLUG			
A91LW	A91LWP	Single wire plug, 12"	100
WT		0.044 lb.	



A65P



SINGLE & TWO-WIRE PLUGS

Wiring/Molded Plug for Thinline Marker/Clearance & Utility Lights

- Standard .156 male bullet on 6" lead wire
- Molded plug fits into surface mount bracket for MC/MCL/UL/UCL65 and MCL61 series lights
- Single wire plug grounds through mounting hardware
- Two-wire plug includes both lead and ground wire

BULK P/N	POLYPACK P/N	DESCRIPTION	QTY
MOLDED PLUGS FOR THINLINE LIGHTS			
A65P	A65PP	Single wire plug, 6"	50
A68P	-	Two-wire plug, 6"	50
WT		Plugs weigh approximately 0.044 lb. each	





A68P

TRUNK & TRAILER CONNECTORS



- A10TH5B tongue extension features 5-way flat plug with one female/four male pins on one end; on other end 5-way flat plug with one male/three female pins, female barrel on blue wire
- A4TC4WB and A6TC4WB trunk connectors feature 4-way flat plug with three female/one male pins
- A18TC replacement trailer connector has one female/ three male pins; A185TC has one female/four male pins
- A48TC replacement trunk connector has one male/three female pins



BULK P/N	POLYPACK P/N	DESCRIPTION	QTY
CONNECTORS			
A10TH5B	A10TH5BP	5-way harness tongue extension, 10-ft	50
A4TC4WB	A4TC4WBP	4-way to bare wire, 4-ft	100
A6TC4WB	A6TC4WBP	4-way to bare wire, 6-ft	50
RETAIL			
A18TC		4-way trailer connector, 18", clam	12
A185TC		5-way trailer connector, 18", clam	12
A48TC		4-way trunk connector, 4-ft, clam	12

7-5 WAY ADAPTORS/PLUGS

Converts two vehicle 7-way round blade connector to 5-way flat pin connector

BULK P/N	POLYPACK P/N	DESCRIPTION	QTY
7-5 WAY ADAPTORS			
A57WB	A57WBP	5-flat to 7-round, 16" cable	25
A75TB	A75TBP	5-flat to 7-round, single piece	50
A7WCB	A7WCBP	7-way power plug, round	50
A57CCB	A57CCBP	5-flat to 7-round, coil cord	30
RETAIL			
A57WH		5-flat to 7-round, 16" cable, clam	6
A75TC		5-flat to 7-round, single piece, clam	12



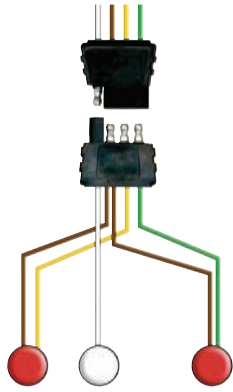

4-WAY WISHBONE STYLE WIRING HARNESSSES

Split wishbone four-conductor harnesses

WIRE DESCRIPTIONS:

WHITE - GROUND
 BROWN - TAIL LAMPS
 YELLOW - DRIVER SIDE STOP/TURN
 GREEN - PASSENGER SIDE STOP/TURN

BULK P/N	POLYPACK P/N	DESCRIPTION	QTY
4-WAY HARNESSSES			
A20WB	A20WBP	20-ft	50
A25WB	A25WBP	25-ft	50
A25R10WB	A25R10WBP	25-ft, #10 ring terminal on ground	50
A25W42B	A25W42BP	25-ft, 42" ground wire	50
A30WB	A30WBP	30-ft	50
A30W10B	A30W10BP	30-ft, 10-ft ground wire	50
A35WB	A35WBP	35-ft	25
A35R10WB	-	35-ft, #10 ring terminal on ground	25
A35W42B	A35W42BP	35-ft, 42" ground wire	50
A36WRB	A36WRBP	36-ft ribbon wiring harness	25
A40W42B	-	40-ft with tubing, 42" ground wire	25
RETAIL			
A25WH		25-ft harness with 4-ft trunk connector, clam	6

5-WAY WISHBONE STYLE WIRING HARNESSSES

Split wishbone five-conductor harnesses have fifth wire for lights or brakes

WIRE DESCRIPTIONS:

- WHITE - GROUND
- BROWN - TAIL LAMPS
- YELLOW - DRIVER SIDE STOP/TURN
- GREEN - PASSENGER SIDE STOP/TURN
- BLUE - AUXILIARY USE

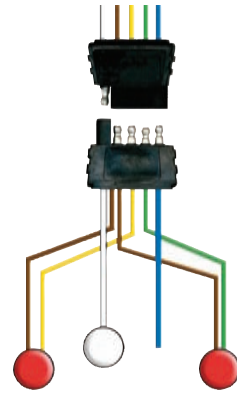

BULK P/N	POLYPACK P/N	DESCRIPTION	QTY
5-WAY HARNESSSES			
A25W5B	A25W5BP	25-ft, 30" ground, 5-ft blue wire	25
A30W5B	A30W5BP	30-ft, 30" ground, 5-ft blue wire	25
A30W5BLB	-	30-ft, 40" ground, 30-ft blue wire	25
A35W5B	A35W5BP	35-ft, 30" ground, 5-ft blue wire	25
A40W5B	A40W5BP	40-ft, 30" ground, 5-ft blue wire	25
A40W542B	-	40-ft with tubing, 42" ground, 5-ft blue wire	25
RETAIL			
A255WH		25-ft harness with 4-ft trunk connector, clam	6

REPLACEMENT BULBS

BULK P/N	POLYPACK P/N	DESCRIPTION	QTY
BULBS			
A2057B	A2057BP	2057, 14V 32/2CP, 1200/5000 hour rating	50
A1157B	A1157BP	1157, 14V 26.9/8.3W, 1200/5000 hour rating	50
A194B	A194BP	194 wedge base, 14V 4CP, 2500 hour rating	100
A921B	-	921 wedge base, 14V 21CP, 500 hour rating	50
RETAIL			
A400		Set, (1) each: 2057, 1157, 194, 168; clam	12
A700		12V 55W H3 quartz halogen, clam	12

MOUNTING GASKETS

Closed cell foam gaskets provide weather tight seal to mounting surface

BULK P/N	POLYPACK P/N	DESCRIPTION	QTY
GASKETS			
A09GB	-	For UCL09 series, black	50
A15GB	-	For MCL15 series, black	50
A13G2B	A13G2BP	For MCL/UCL13 series, black	200
A17GB	A17GBP	For MCL17 series, black	100
A25GB	A25GBP	For LP25SB license light bracket, black	100
A32GB	A32GBP	For MC32 series, white	500
A42GB	A42GBP	For ST40 & STL42 series, black	100
A44GTB	-	Thick, for MC/MCL44 series, white	1000
A52GB	-	For MCL52 series, black	100
A55LGB	-	For LPL55 series, 2mm black	100
A66GB	A66GBP	For MCL66 series, black	100
A69GB	-	For MCL70/STL69 series, black	50
A73GB	-	For STL73 series, black	100

MOUNTING HARDWARE

Hardware sets for mounting tail lights. See contents below. Components packaged separately.

BULK P/N	USE WITH	DESCRIPTION	QTY
HARDWARE SETS			
A830B	ST/STL16/17	(1) each: 1/4" 20 flange lock nut, 1/4" flat washer, 1/4" split lock washer; stainless	100
A839B	ST/STL16/17	(1) each: 1/4" 20 flange lock nut, 1/4" flat washer, 1/4" split lock washer; zinc plated	100

FLASHER

BULK P/N	POLYPACK P/N	DESCRIPTION	QTY
FLASHER			
ALEDFB	ALEDFBP	LED flasher with connectors	10

FEDERAL LIGHTING REGULATIONS FOR TRAILERS

IMPORTANT NOTE: Every lamp, reflex reflector, and conspicuity treatment must be permanently attached in the location specified below and must comply with all applicable requirements prescribed for it by FMVSS/CMVSS 108. The face of any device on the front/rear and sides should be, respectively perpendicular and parallel to the vehicle's centerline, unless it is photometrically certified at installation angle. No part of the vehicle shall prevent any device from meeting its prescribed requirements unless an auxiliary device meeting all prescribed requirements is installed. **IN CANADA:** Manufacturers and importers of vehicles must have the proper certification test records demonstrating compliance of lighting components with all prescribed requirements.



BASIC EQUIPMENT REQUIRED ON ALL TRAILERS

DESCRIPTION				MANDATORY REQUIREMENTS			
Area	Equipment	SAE Lens Coding	Functional Purpose	Quantity	Color	Location	Height mm(in.) from the ground
1	Tail Lamps	(T)	Indicate vehicle's presence and width	Minimum 2	Red	On the rear - symmetrical as far apart as practicable	380-1830 (15-72)
	Stop Lamps	(S)	Indicate braking	Minimum 2	Red	On the rear - symmetrical as far apart as practicable	380-1830 (15-72)
	Rear Turn Signal Lamps	(I)	Indicate direction of turn	Minimum 2	Red or Yellow	On the rear - symmetrical as far apart as practicable	380-2110 (15-83)
	Rear Reflex Reflectors	(A)	Indicate vehicle's presence and width	Minimum 2	Red	On the rear - symmetrical as far apart as practicable facing rearward	380-1530 (15-60)
2	License Plate Lamp(s)	(L)	Illuminates license plate	Minimum 1	White	On the rear - above or at the sides of license plate	No requirement
3	Rear Side Marker Lamps <small>*photometrically certified at installation angle</small>	(P2, PC* or P3, PC2*)	Front and rear side marker lamps / side reflex reflectors indicate vehicle's presence and length	Minimum 2	Red	Each side at rear as far back as practicable	380-1530 (15-60) no max. for veh. under 2032mm (80") wide
	Rear Side Reflex Reflectors	(A)		Minimum 2	Red	Each side at rear as far back as practicable facing sideward	380-1530 (15-60)
4	a Front Side Marker Lamps <small>*photometrically certified at installation angle</small>	(P2, PC* or P3, PC2*)	Front and rear side marker lamps / side reflex reflectors indicate vehicle's presence and length	Minimum 2	Yellow	Each side at front as far forward as practicable	380 (15) minimum
	b Front Side Reflex Reflectors	(A)		Minimum 2	Yellow	Each side at front as far forward as practicable facing sideward	380-1530 (15-60)

ADDITIONAL EQUIPMENT FOR TRAILERS EXCEEDING THE FOLLOWING PARAMETERS Length 9.1m (30 ft.) or longer

DESCRIPTION				MANDATORY REQUIREMENTS			
Area	Equipment	SAE Lens Coding	Functional Purpose	Quantity	Color	Location	Height mm(in.) from the ground
5	a Intermediate Side Marker Lamps	(P2 or P3)	Indicate presence of a long vehicle	Minimum 2	Yellow	Each side near center facing sideward	380 (15) minimum
	b Intermediate Side Reflex Reflectors	(A)	Indicate presence of a long vehicle	Minimum 2	Yellow	Each side near center facing sideward	380-1530 (15-60)

Width 2032mm (80 in.) or wider

DESCRIPTION			MANDATORY REQUIREMENTS				
Area	Equipment	SAE Lens Coding	Functional Purpose	Quantity	Color	Location	Height
6	Rear Clearance Lamps <small>*photometrically certified at installation angle</small>	(P2, PC* or P3, PC2*)	Show vehicle's width MAY NOT be combined with tail lamps	Minimum 2	Red	At widest point - symmetrical on the rear or near the rear facing rearward	As high as practicable may be lower only if ID lamps are at the top
7	Rear Identification (ID) Lamps	(P2 or P3)	Indicate presence of a wide vehicle	Exactly 3	Red	On the rear - center horizontally spaced 150mm (6 in.) to 300mm (12 in.) apart facing rearward	At the top - may be lower if door header narrower than 25mm
8	Front Clearance Lamps <small>*photometrically certified at installation angle</small>	(P2, PC* or P3, PC2*)	Show vehicle's width	Minimum 2	Yellow	At widest point - symmetrical on the front or near the front facing forward	As high as practicable

Width 2032mm (80 in.) or wider AND GVWR 4536 kg (10,000 lb.) or more

DESCRIPTION		MANDATORY REQUIREMENTS						
Area	Conspicuity Treatment	DOT Coding	Quantity	Color	Location	Height	Options	
9	Rear Upper Body Markings	DOT-C DOT-C2 DOT-C3 DOT-C4	Exactly 2 pairs of 300mm long strips	White	On the rear upper corners facing rearward	At the top	Optional in Canada: Rear lower body and side conspicuity treatment may also be solid white, solid yellow, or white and yellow.	
10	Bumper Bar Marking		Continuous	Red/White	On the rear bumper bar's horizontal element full width - facing rearward	No requirement		
11	Rear Lower Body Marking		Continuous	Red/White (see options)	On the rear full width of the vehicle facing rearward	As horizontal as practicable and as close as practicable to the range of 375 to 1525mm from the ground		
12	Side Marking		(see location)	Red/White (see options)	Each side - facing sideward continuous, or evenly spaced over minimum of 50% of length starts and ends as close to the front and rear of the vehicle as practicable	As horizontal as practicable and as close as practicable to the range of 375 to 1525mm from the ground		

NOTE: The edge of red conspicuity tape shall not be closer than 75 mm to the edge of any amber lamp and the edge of white conspicuity tape shall not be closer than 75 mm to the edge of any lamp

For more information contact: Transport Canada: Motor Vehicle Safety Enforcement Branch
National Highway Traffic Safety Administration: Office of Safety Performance Standards

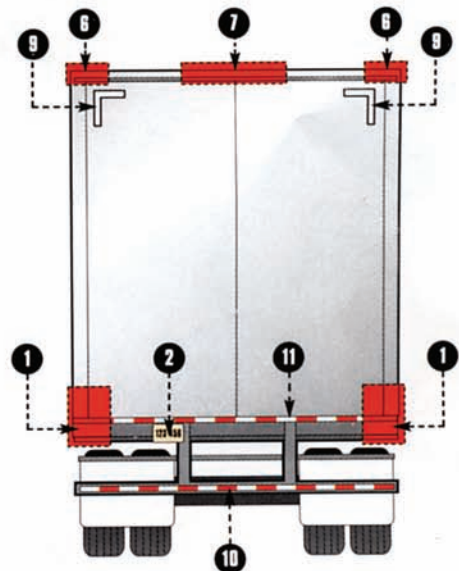
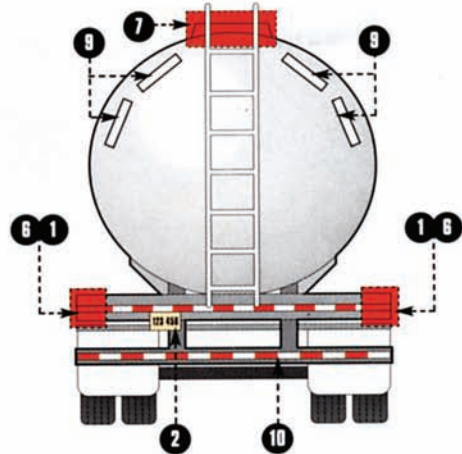
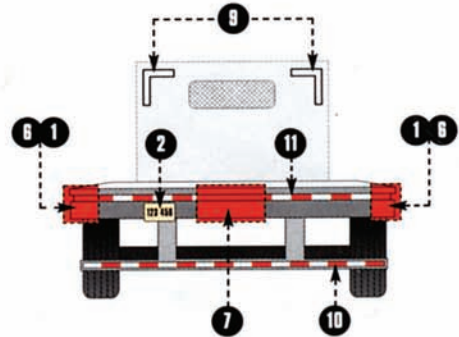
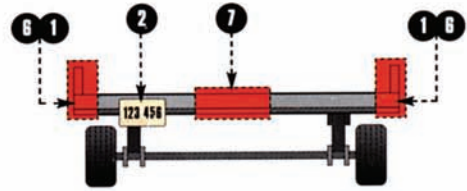
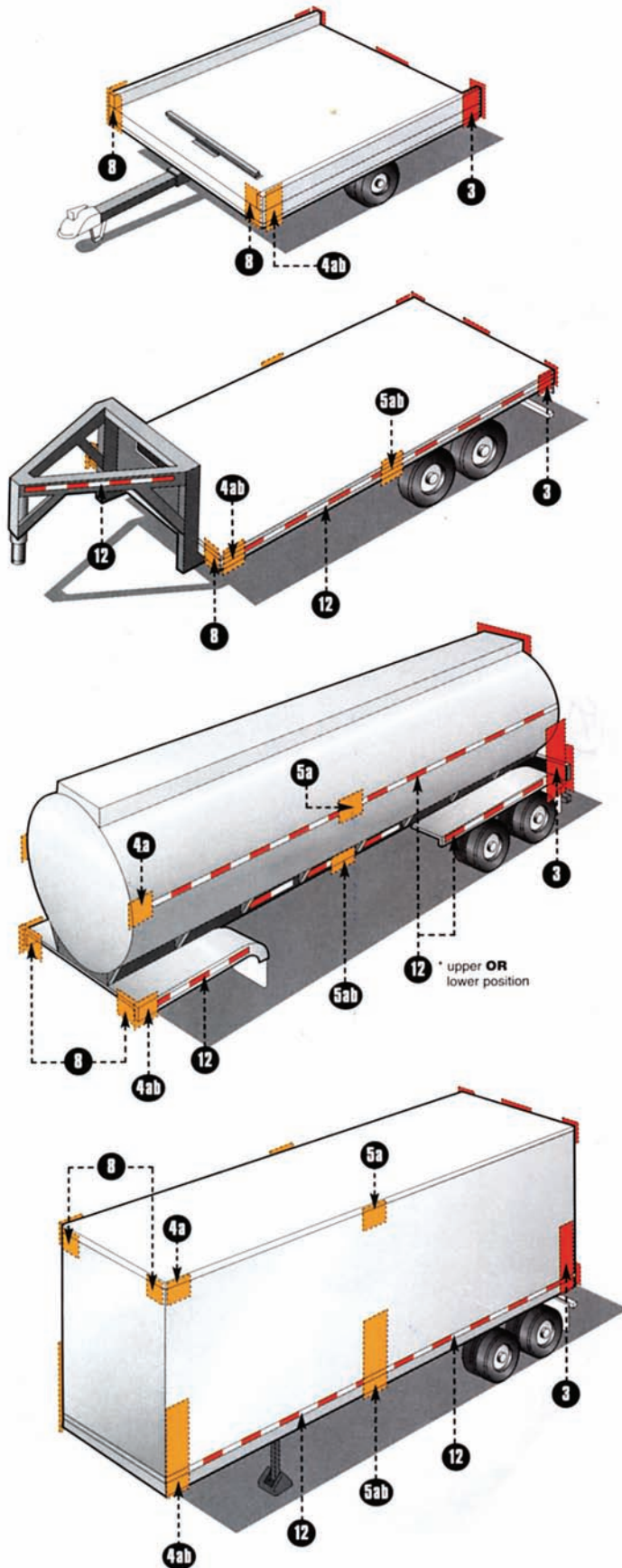

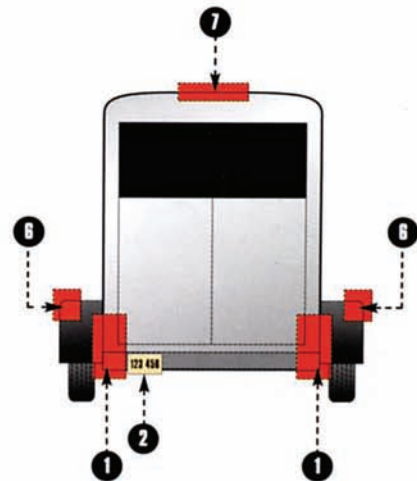
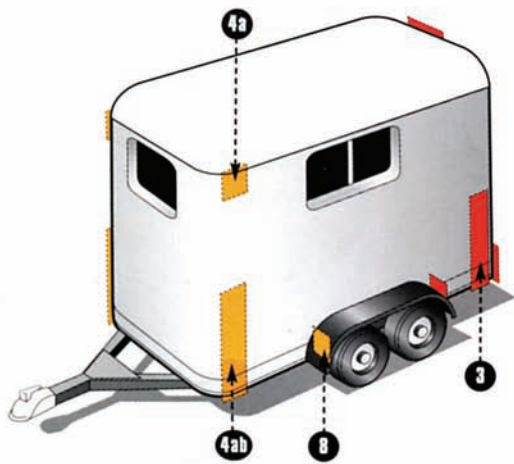
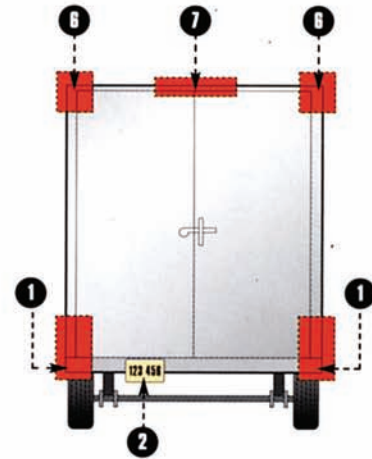
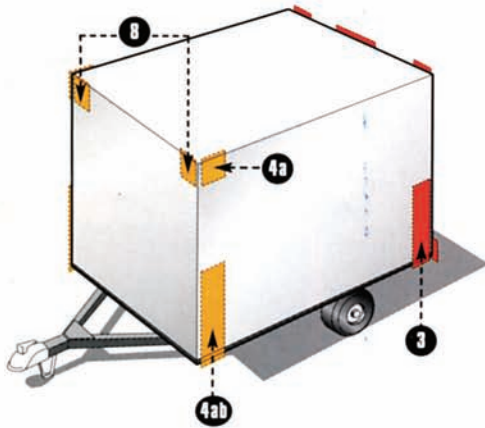
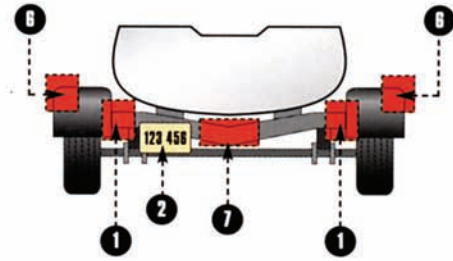
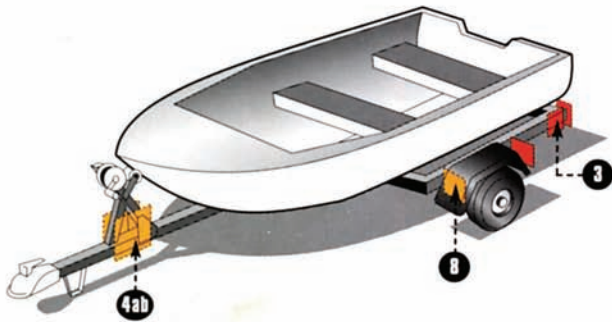
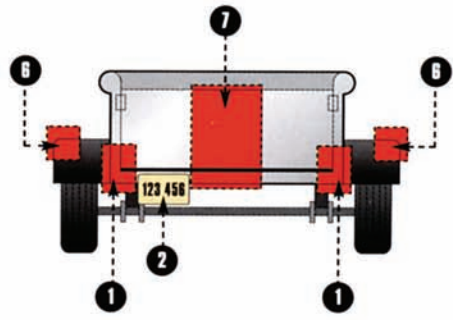
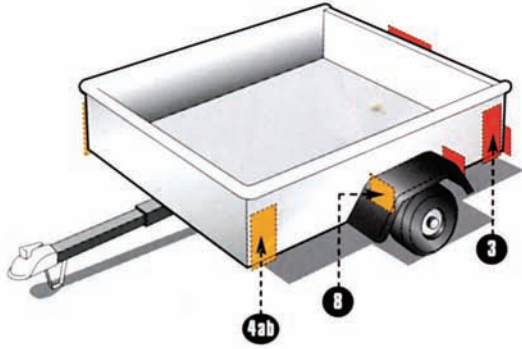

FEDERAL LIGHTING REGULATIONS FOR TRUCKS, BUSES & MPVs

IMPORTANT NOTE: Every lamp, reflex reflector, and conspicuity treatment must be permanently attached in the location specified below and must comply with all applicable requirements prescribed for it by FMVSS/CMVSS 108. The face of any device on the front/rear and sides should be, respectively perpendicular and parallel to the vehicle's centerline, unless it is photometrically certified at installation angle. No part of the vehicle shall prevent any device from meeting its prescribed requirements unless an auxiliary device meeting all prescribed requirements is installed. **IN CANADA:** Manufacturers and importers of vehicles must have the proper certification test records demonstrating compliance of lighting components with all prescribed requirements.



BASIC EQUIPMENT REQUIRED ON ALL TRUCKS, BUSES & MPVs

DESCRIPTION				MANDATORY REQUIREMENTS			
Area	Equipment	SAE Lens Coding	Functional Purpose	Quantity	Color	Location	Height mm(in.) from the ground
1	Headlamps - Lower Beam <small>US requires "DOT" lettering on lens US & Canada - light source code required on lens</small>	(H, HR)	Forward road illumination	Minimum 2	White	On the front - symmetrical as far apart as practicable <small>If 4 lamp system - outboard or above upper beams</small>	560-1370 (22-54)
	Headlamps - Upper Beam <small>US requires "DOT" lettering on lens US & Canada - light source code required on lens</small>	(H, HR)	Forward road illumination	Minimum 2	White	On the front - symmetrical <small>If 4 lamp system - inboard or below lower beams</small>	560-1370 (22-54)
	Parking Lamps <small>Vehicles less than 2032mm wide</small>	(P)	Indicate parked vehicle	Minimum 2	White or Yellow	On the front - symmetrical as far apart as practicable	380-1830 (15-72)
	Daytime Running Lamps (DRL) <small>Canada - required / US - option US requires "DRL" lettering on lens if not headlamp</small>	(Y2)	Indicate in use vehicle	Minimum 2	White or Yellow	On the front - symmetrical as far apart as practicable	380 (15) min. <small>Max. depends on type of DRL</small>
	Front Turn Signal/ Hazard Warning Lamps	(I)	Indicate direction of turn/ identify disabled vehicle	Minimum 2	Yellow	On the front - symmetrical as far apart as practicable	380-2110 (15-83)
2	Front Clearance Lamps <small>Vehicles 2032mm wide or wider *photometrically certified at installation angle</small>	(P2, PC* or P3, PC2*)	Show vehicle's width	Minimum 2	Yellow	At widest point - symmetrical on the front or near the front facing forward	As high as practicable
3	Front Identification Lamps (ID) <small>Vehicles 2032mm wide or wider</small>	(P2 or P3)	Indicate presence of a wide vehicle	Exactly 3	Yellow	On the front - center horizontally spaced 150mm (6 in.) to 300mm (12 in.) apart	As high as practicable or on top of the cab
4	a Front Side Marker Lamps <small>*photometrically certified at installation angle</small>	(P2, PC* or P3, PC2*)	Front and rear side marker lamps / side reflex reflector indicate vehicle's presence and length	Minimum 2	Yellow	Each side at front as far forward as practicable	380 (15) minimum
	b Front Side Reflex Reflectors	(A)		Minimum 2	Yellow	Each side at front as far forward as practicable facing sideward	380-1530 (15-60)
5	a Rear Side Marker Lamps** <small>*photometrically certified at installation angle</small>	(P2, PC* or P3, PC2*)		Minimum 2	Red	Each side at rear as far back as practicable	380 (15) minimum
	b Rear Side Reflex Reflectors** <small>**not required on Truck Tractors</small>	(A)		Minimum 2	Red	Each side at rear as far back as practicable facing sideward	380-1530 (15-60)
6	Rear Clearance Lamps <small>Vehicles 2032mm wide or wider Not required on Truck Tractors *photometrically certified at installation angle</small>	(P2, PC* or P3, PC2*)		Show vehicle's width MAY NOT be combined with tail lamps	Minimum 2	Red	At widest point - symmetrical on the rear or near the rear facing rearward
7	Rear Identification (ID) Lamps <small>Vehicles 2032mm wide or wider Not required on Truck Tractors</small>	(P2 or P3)	Indicate presence of a wide vehicle	Exactly 3	Red	On the rear - center horizontally spaced 150mm (6 in.) to 300mm (12 in.) apart facing rearward	At the top - may be lower if door header narrower than 25mm
8	Tail Lamps	(T)	Indicate vehicle's presence and width	Minimum 2	Red	On the rear - symmetrical as far apart as practicable	380-1830 (15-72)
	Stop Lamps	(S)	Indicate braking	Minimum 2	Red	On the rear - symmetrical as far apart as practicable	380-1830 (15-72)
	Rear Turn Signal/ Hazard Warning Lamps	(I)	Indicate direction of turn/ identify disabled vehicle	Minimum 2	Red or Yellow	On the rear - symmetrical as far apart as practicable	380-2110 (15-83)
	Rear Reflex Reflectors	(A)	Show vehicle's presence and width	Minimum 2	Red	On the rear - symmetrical as far apart as practicable	380-1530 (15-60)
9	Backup Lamp	(R)	Illuminates ground behind the vehicle and alert road users	Minimum 1	White	Rear	No requirement
10	License Plate Lamp(s)	(L)	Illuminates license plate	Minimum 1	White	On the rear - above or at the sides of license plate	No requirement
11	Center High Mounted Stop Lamp <small>Vehicles less than 2032mm wide and 4536kg</small>	(U3)	Indicates braking	1	Red	On the rear - centerline of the vehicle	860 (34) minimum

ADDITIONAL EQUIPMENT FOR SPECIFIC VEHICLES VEHICLES 9.1m (30 ft.) LONG OR LONGER

DESCRIPTION				MANDATORY REQUIREMENTS			
Area	Equipment	SAE Lens Coding	Functional Purpose	Quantity	Color	Location	Height mm(in.) from the ground
12	a Intermediate Side Marker Lamps	(P2 or P3)	Indicate presence of a long vehicle	Minimum 2	Yellow	Each side near center	380 (15) minimum
	b Intermediate Side Reflex Reflectors	(A)	Indicate presence of a long vehicle	Minimum 2	Yellow	Each side near center facing sideward	380-1530 (15-60)

Truck Tractors

DESCRIPTION		MANDATORY REQUIREMENTS					
Area	Conspicuity Treatment	DOT Coding	Quantity	Color	Location	Height	Options
13	Rear Upper Body Markings	DOT-C DOT-C2 DOT-C3 DOT-C4	Exactly 2 pairs of 300mm long strips	White	Rear upper corners of cab facing rearward	As high as practicable excluding fairings	
14	Rear Marking		Exactly 2 sections of min. 600mm each	Red/White	Rear - facing rearward - on fenders, on mud flap brackets, or within 300mm below the top of mud flaps	As horizontal as practicable and not higher than 1525mm from the ground	If mud flaps not used - on the cab or frame mounted brackets

NOTE: The edge of red conspicuity tape shall not be closer than 75 mm to the edge of any amber lamp and the edge of white conspicuity tape shall not be closer than 75 mm to the edge of any lamp

For more information contact: Transport Canada: Motor Vehicle Safety Enforcement Branch
National Highway Traffic Safety Administration: Office of Safety Performance Standards

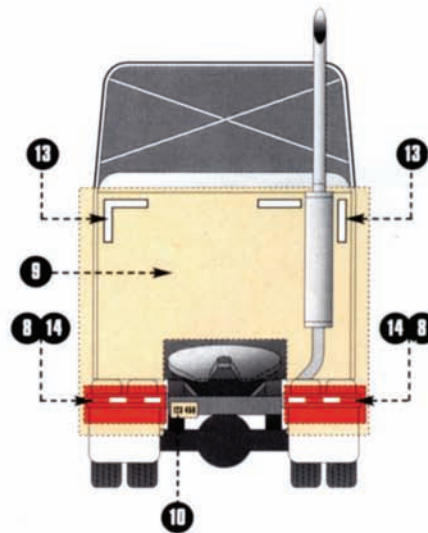
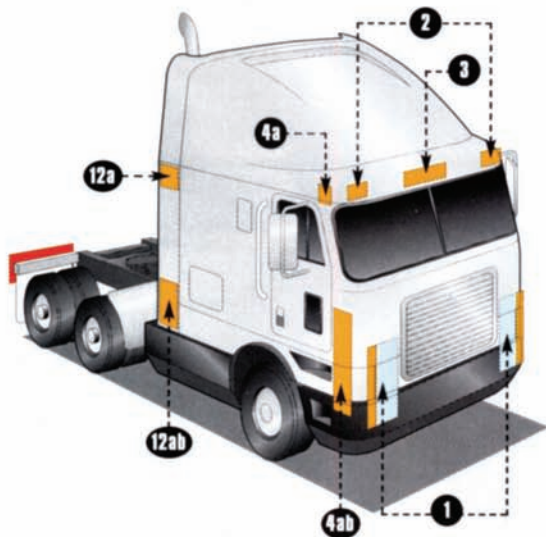
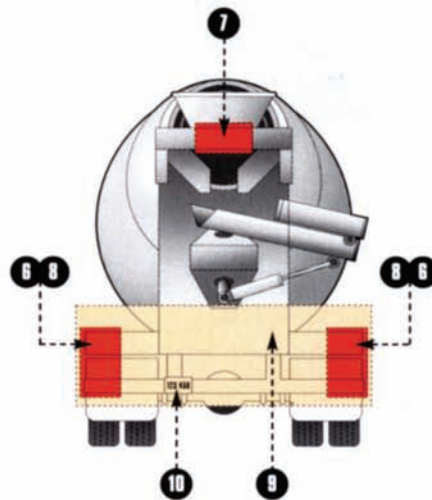
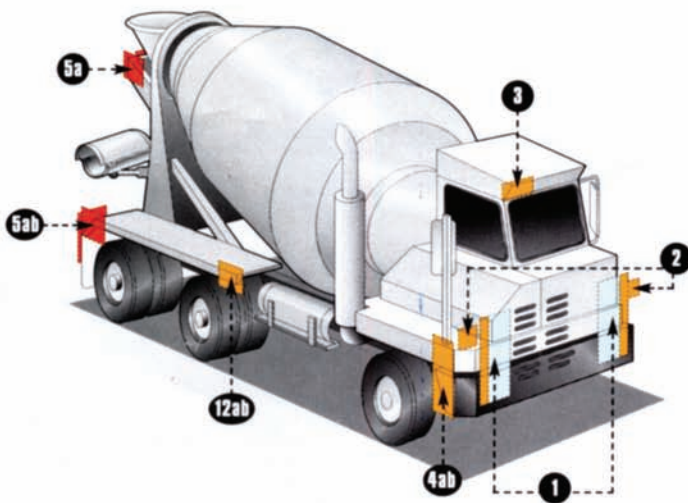
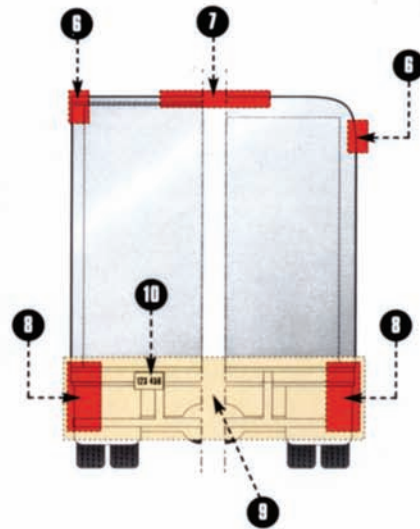
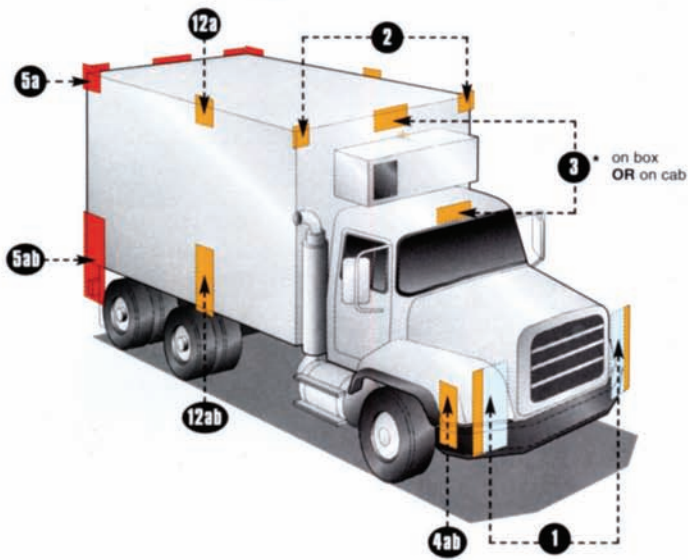

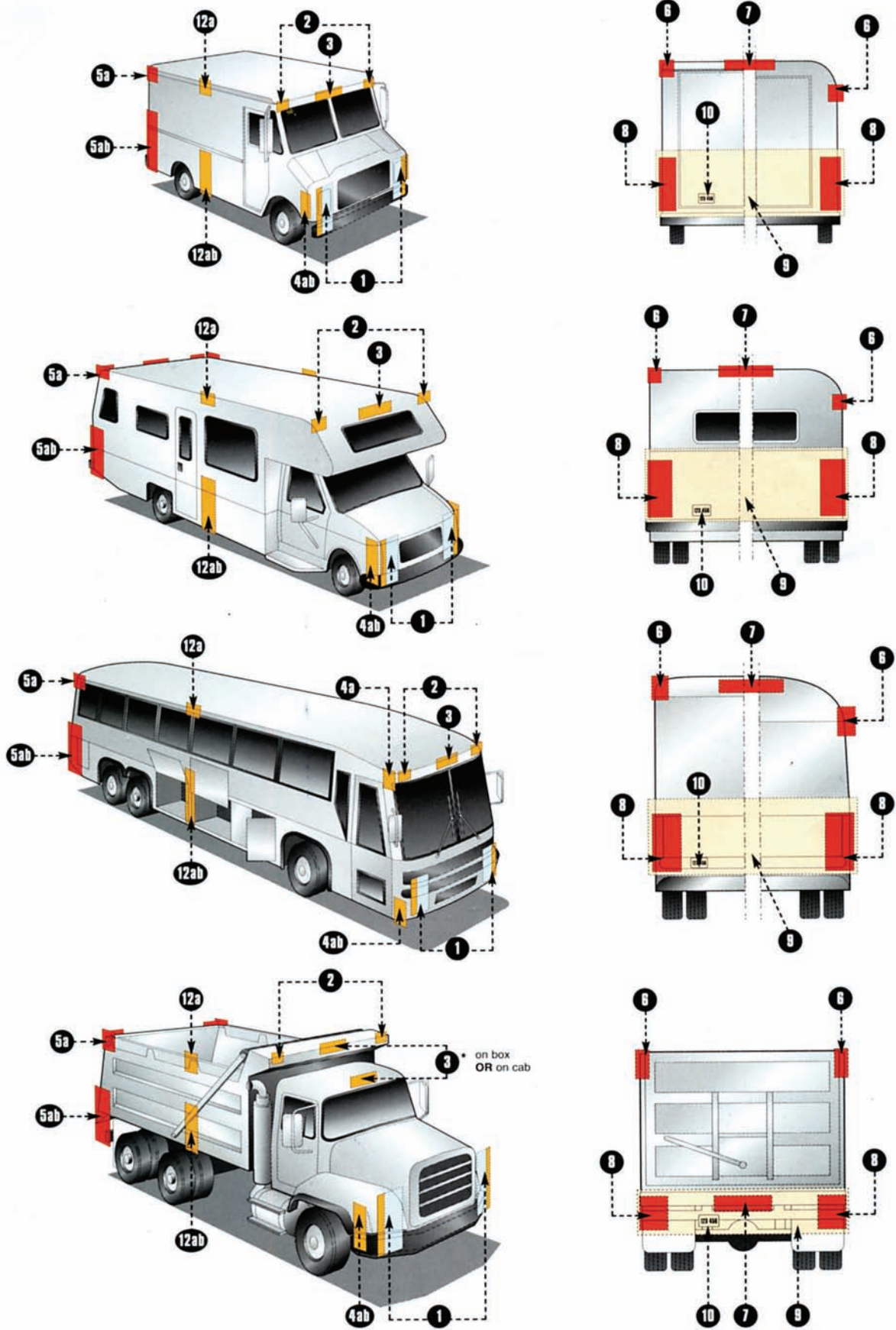

Truck & Trailer Regulation – FMVSS 108 (49CFR 571.108)

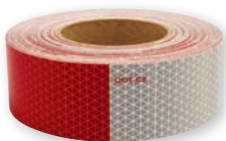
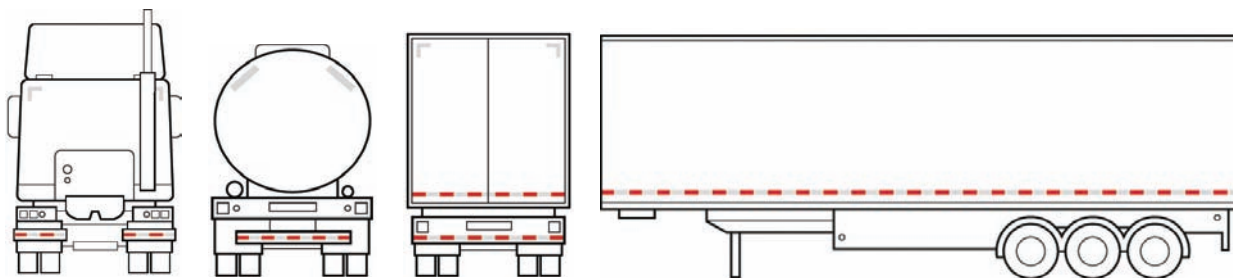

APPLICATION LOCATIONS:

Rear Upper Body

12" WHITE strips placed in the upper rear corners

Rear Lower Body

- 2" wide RED/WHITE tape placed on rear full width of vehicle
- 2" wide RED/WHITE tape minimum 24" length on fender, mudflap brackets or within 12" below the top of mudflaps

Side Marking

2" wide RED/WHITE tape placed on each side of trailer continuous or evenly spaced over 50% of the vehicle

School Bus Regulation – FMVSS 131 & 217

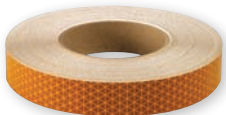
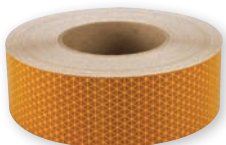
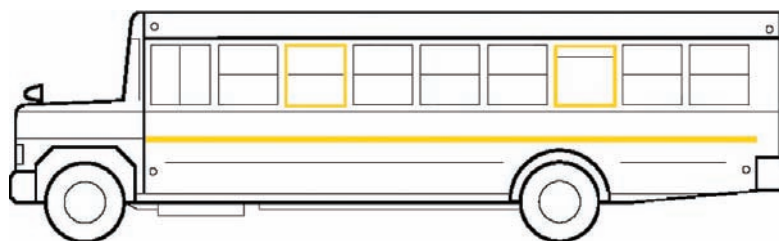

Each opening for a required emergency exit shall be outlined around its outside perimeter with a retroreflective tape with a minimum width of 1 inch and either red, white, or yellow in color, that when tested under the conditions specified in S6.1 of Standard No. 131 (49 CFR 571.131), meets the criteria specified.

APPLICATION LOCATIONS:

- 1" strips used to mark side emergency exit windows
- 1" strips used to mark back emergency exit windows



00212005P 155	00212337P 58	04440013B 215	11212703B 57	2500189P 228
00212010B 155	00212338P 58	04440013P 215	11212708P 57	30000000B 230
00212011B 155	00212342B 155	04440016B 215	11212709P 57	30031010B 230
00212013P 155	00212342P 155	04440016P 215	11212710P 57	302B 230
00212031B 155	00212345P 58	06001001B 224	11212711P 57	302P 230
00212031P 155	00212346P 58	06001001P 224	13000018B 229	30655010B 230
00212104B 60	00212347P 58	06001013B 222	13000018P 229	3202B 230
00212108B 60	00212351B 155	06001013P 222	15011001B 218	3202P 230
00212117B 60	00212351P 155	06001014B 222	1502B 230	357B 226
00212127P 60	00212353B 155	06001014P 222	1502P 230	357P 226
00212135P 60	00212353P 155	06001015B 223	15202B 230	3801071BZL 222
00212137P 60	00212355P 58	06001015P 223	15202P 230	3801071BZLP 222
00212155P 60	00212356P 58	06001022B 220	16802B 214	3802071BZL 222
00212157P 60	00212357P 58	06001022P 220	16802P 214	3802071BZLP 222
00212207B 59	00212358P 58	06001026B 223	17612125B 217	500302B 229
00212209B 59	00212362B 155	06001026P 223	17612195B 216	500302P 229
00212213B 59	00212362P 155	06001037B 223	17612280B 216	510001B 229
00212214B 59	00212365P 58	06001037P 223	17918135B 217	510001P 229
00212217B 57	00212366P 58	06001048B 223	17918135BP 217	520002B 229
00212223B 156	00212367P 58	06001048P 223	17918190B 216	520002P 229
00212224B 156	00212368P 58	06001061B 223	17918190BP 216	530002B 229
00212227P 57	00212376B 58	06001061P 223	17918386B 216	530002P 229
00212231B 156	00212378B 58	06001072B 223	17918386BP 216	69000200B 226
00212231P 156	00212384B 58	06001072P 223	18543910B 225	69000200P 226
00212233B 156	00212386B 58	06002001B 224	18543916B 225	69000201B 227
00212233P 156	00212700B 61	06002001P 224	18543936B 225	69000201P 227
00212235P 59	00212701B 61	060102B 224	19102B 214	69000300B 227
00212236P 59	00212702B 61	060102P 224	19102P 214	69000300P 227
00212237P 59	00212703B 61	0601B 224	193BSP 227	725022B 222
00212238P 59	00212704P 61	0601P 224	193BSPP 227	725022P 222
00212239B 156	00212705P 61	06300003B 224	193G 227	726022B 222
00212239P 156	00212706P 61	06300003P 224	193P 227	726022P 222
00212251B 156	00212707P 61	06300004B 224	240040002B 220	7850NFRCP 229
00212251P 156	00212708P 61	06300004P 224	240047171B 220	7850NFRCP 229
00212253B 156	00212709P 61	068NME 214	240047171LB 220	825L 221
00212253P 156	00212710P 61	068NMEP 214	240047171P 220	825LED 221
00212254P 59	00212711P 61	068WMTE 214	24004TR71 220	825LP 221
00212255P 59	00212712P 61	068WMTEP 214	24004TR71P 220	825TR02 221
00212256P 59	00212713B 61	09017101B 230	240147171B 220	825TR02P 221
00212257P 59	00212713P 61	09017101P 230	240147171LB 220	826L 221
00212258P 59	00212714P 61	105500SP 225	240147171P 220	826LED 221
00212259B 156	00212715B 61	105520B 225	24014TR71 220	826LP 221
00212259P 156	00212717B 57	105520BP 225	24014TR71P 220	826TR02 221
00212261P 59	00212727P 57	11212207B 57	24074B 215	826TR02P 221
00212262P 59	00212757B 60	11212209B 57	24074P 215	826TR12 221
00212263P 59	00212757P 60	11212255P 57	2407764B 215	826TR90 221
00212276B 59	00212767B 60	11212256P 57	2407764P 215	A09BB 248
00212278B 59	01180071B 228	11212257P 57	2407765B 215	A09BBP 248
00212293P 156	01180071P 228	11212258P 57	2407765P 215	A09CB 248
00212294P 156	01180089B 228	11212276B 57	2407768B 215	A09CBP 248
00212307B 58	01180089P 228	11212278B 57	2407768P 215	A09GB 258
00212309B 58	01180090B 228	11212307B 56	2407771C 215	A09WB 248
00212315B 58	01180090BP 228	11212309B 56	2407771CP 215	A09WBP 248
00212316B 58	014BCRCW 229	11212355P 56	2409171B 230	A101TRSSB 244
00212317B 56	014BCRCWP 229	11212356P 56	2409171BP 230	A101TRSSBP 244
00212327P 56	03001150B 219	11212357P 56	24113160B 226	A10TH5B 255
00212331B 155	03001150P 219	11212358P 56	24113160P 226	A10TH5BP 255
00212331P 155	03001175B 219	11212376B 56	2500128B 228	A111TRSSB 246
00212333B 155	03001175P 219	11212378B 56	2500128P 228	A111TRSSBP 246
00212333P 155	04010009B 218	11212700B 57	2500171B 228	A1157B 257
00212335P 58	04010040B 218	11212701B 57	2500171P 228	A1157BP 257
00212336P 58	04010040P 218	11212702B 57	2500189B 228	A11AB 166

INDEX

A11ABP.....	166	A25GBP.....	258	A40W5B.....	257	A55GBP.....	237	A69RCB.....	248
A11AXB.....	234	A25R10WB.....	256	A40W5BP.....	257	A55GK.....	237	A69RCBP.....	248
A11BLPB.....	105	A25R10WBP.....	256	A42AB.....	171	A55GKP.....	237	A6TC4WB.....	255
A11BLPBP.....	105	A25TRSSB.....	238	A42ABP.....	171	A55GWB.....	237	A6TC4WBP.....	255
A11GB.....	235	A25TRSSBP.....	238	A42FCB.....	244	A55LGB.....	258	A700.....	257
A11GBP.....	235	A25W42B.....	256	A42FCBP.....	244	A56GB.....	237	A70GB.....	245
A11GLPB.....	105	A25W42BP.....	256	A42GB.....	258	A56GBP.....	237	A70GBP.....	245
A11GLPBP.....	105	A25W5B.....	257	A42GBP.....	258	A57CB.....	238	A73GB.....	258
A11PB.....	235	A25W5BP.....	257	A42RB.....	171	A57CBP.....	238	A75TB.....	255
A11PBP.....	235	A25WB.....	256	A42RBP.....	171	A57CCB.....	255	A75TBP.....	255
A11RB.....	166	A25WBP.....	256	A44A500B.....	172	A57CCBP.....	255	A75TC.....	255
A11RBP.....	166	A25WH.....	256	A44AB.....	172	A57GB.....	237	A77SB.....	245
A11RXB.....	234	A2RB.....	146	A44ABP.....	172	A57GBP.....	237	A77SBP.....	245
A11SRB.....	235	A2RBP.....	146	A44GTB.....	258	A57GK.....	237	A78CB1.....	246
A11SRBP.....	235	A30W10B.....	256	A44R500B.....	172	A57GKP.....	237	A78CB1P.....	246
A11SSB.....	235	A30W10BP.....	256	A44RB.....	172	A57WB.....	255	A78RXB.....	246
A11SSBP.....	235	A30W5B.....	257	A44RBP.....	172	A57WBP.....	255	A78RXBP.....	246
A12B2LPB.....	105	A30W5BLB.....	257	A45BB.....	243	A57WH.....	255	A79CB.....	248
A12B2LPBP.....	105	A30W5BP.....	257	A45BBP.....	243	A58GB.....	237	A7TRSSB.....	246
A12GB.....	235	A30WB.....	256	A45CB.....	252	A58GBP.....	237	A7TRSSBP.....	246
A12GBP.....	235	A30WBP.....	256	A45CBP.....	252	A5TRSSB.....	244	A7WCB.....	255
A12GLPB.....	105	A31AB.....	168	A45CGB.....	244	A5TRSSBP.....	244	A7WCBP.....	255
A12GLPBP.....	105	A31ABP.....	168	A45CGBP.....	244	A60RB.....	151	A81AB.....	176
A13B2B.....	248	A31RB.....	168	A45GB.....	243	A60RBP.....	151	A81ABP.....	176
A13B2BP.....	248	A31RBP.....	168	A45GBP.....	243	A61EZPG.....	162	A81RB.....	176
A13C2B.....	248	A32AB.....	168	A45PB.....	251	A65B.....	239	A81RBP.....	176
A13C2BP.....	248	A32ABP.....	168	A45PBP.....	251	A65BP.....	239	A82AB.....	176
A13G2B.....	258	A32GB.....	258	A45PMB.....	251	A65P.....	254	A82ABP.....	176
A13G2BP.....	258	A32GBP.....	258	A45PMBP.....	251	A65PB.....	239	A82BB.....	242
A14GB.....	235	A32RB.....	168	A45PS.....	251	A65PBP.....	239	A82BBP.....	242
A14GBP.....	235	A32RBP.....	168	A45SB.....	243	A65PBPBPG.....	239	A82CRB.....	242
A15BB.....	248	A33GB.....	247	A45SBP.....	243	A65PP.....	254	A82CRBP.....	242
A15BBP.....	248	A33GBP.....	247	A46P135B.....	253	A65PRXB.....	239	A82RB.....	176
A15CB.....	248	A35R10WB.....	256	A46P36B.....	253	A65TB.....	239	A82RBP.....	176
A15CBP.....	248	A35W42B.....	256	A46P75B.....	253	A66AB.....	173	A830B.....	258
A15GB.....	258	A35W42BP.....	256	A46PB.....	253	A66ABP.....	173	A839B.....	258
A16R.....	148	A35W5B.....	257	A46PBP.....	253	A66GB.....	258	A86PB.....	253
A16RB.....	148	A35W5BP.....	257	A46PPG.....	253	A66GBP.....	258	A86PBP.....	253
A16RBP.....	148	A35WB.....	256	A46PPGP.....	253	A66PB.....	239	A8R.....	144
A178TRSSB.....	246	A35WBP.....	256	A46PS.....	253	A66PBP.....	239	A8RB.....	144
A178TRSSBP.....	246	A36AB.....	169	A47PB.....	251	A66RB.....	173	A8RBP.....	144
A17GB.....	258	A36ABP.....	169	A47PBP.....	251	A66RBP.....	173	A8RK.....	144
A17GBP.....	258	A36R.....	149	A47PS.....	251	A67BB.....	240	A90CB.....	242
A17RB.....	148	A36RB.....	169	A48CB.....	248	A67BBP.....	240	A91AB.....	165
A17RBP.....	148	A36RBP.....	169	A48CBP.....	248	A67CB.....	239	A91ABP.....	165
A185TC.....	255	A36WRB.....	256	A48TC.....	255	A67CBP.....	239	A91BB.....	242
A18TC.....	255	A36WRBP.....	256	A49PB.....	252	A67CBPG.....	239	A91BBP.....	242
A194B.....	257	A37RB.....	149	A49PBP.....	252	A67CVB.....	240	A91BOB.....	242
A194BP.....	257	A37RBP.....	149	A4TC4WB.....	255	A67CVBP.....	240	A91BOBP.....	242
A2057B.....	257	A38AB.....	170	A4TC4WBP.....	255	A67GB.....	240	A91CB.....	242
A2057BP.....	257	A38ABP.....	170	A52AB.....	141	A67GBP.....	240	A91CBP.....	242
A20R.....	143	A38RB.....	170	A52ABP.....	141	A67P10G.....	239	A91G15B1.....	241
A20WB.....	256	A38RBP.....	170	A52GB.....	258	A68AB.....	174	A91G15B1P.....	241
A20WBP.....	256	A39RB.....	149	A52RB.....	141	A68ABP.....	174	A91GB.....	241
A21CHB.....	248	A39RBP.....	149	A52RBP.....	141	A68P.....	254	A91GBP.....	241
A21CHBP.....	248	A3TRSSB.....	236	A54GB.....	236	A68PB.....	239	A91GOB.....	241
A21WB.....	248	A3TRSSBP.....	236	A54GBP.....	236	A68PBP.....	239	A91GOBP.....	241
A21WBP.....	248	A400.....	257	A54GK.....	236	A68RB.....	174	A91GZB.....	241
A24RB.....	142	A40SRB.....	247	A54GKP.....	236	A68RBP.....	174	A91LW.....	254
A24RBP.....	142	A40SRBP.....	247	A55CB.....	236	A69CB.....	248	A91LWP.....	254
A255WH.....	257	A40W42B.....	256	A55CBP.....	236	A69CBP.....	248	A91OB.....	242
A25GB.....	258	A40W542B.....	257	A55GB.....	237	A69GB.....	258	A91OBP.....	242

A91RB..... 165	AST61B 200	BUL10CBP 52	CB11AS 178	ILL22CHB 120
A91RBP 165	AST61BP 200	BUL10CMB 52	CB11WAB 178	ILL22CHBP 120
A921B..... 257	BA44FNL..... 172	BUL10CMBP 52	CB11WABP 178	ILL24CB 120
A93PB..... 253	BA44FNLP..... 172	BUL111CB 50	CB15AK..... 178	ILL24CBP 120
A93PBP..... 253	BA44FNRP 172	BUL111CBP 50	CB20AB 179	ILL28CMB 118
A9R..... 144	BA44FNRP 172	BUL111CB 48	CB20ABP 179	ILL28CMBP 118
A9RB..... 144	BA65ARLB 163	BUL111CBP 48	CB22AB 179	ILL28CMPG 118
A9RBP 144	BA65ARLB 163	BUL111CBX 48	CB22ABP 179	ILL30CBB 121
AIL21B 212	BA65ARRB..... 163	BUL111CBXP 48	CB22RB 179	ILL30CBBP 121
AIL21BP 212	BA65ARRBP..... 163	BUL111CKB 48	CB22RBP 179	ILL31CB 121
AIL32B 209	BK31BB 249	BUL111CKBP 48	CBL22AB 100	ILL31CBP 121
AL190AB 80	BK31BBP 249	BUL111CM24B 48	CBL22ABP 100	ILL32CB 121
AL190ABP 80	BK42CB 247	BUL111CM24BP 48	CBL22CAB 100	ILL32CBP 121
AL190RB 80	BK42CBP 247	BUL111CMB 48	CBL22RB..... 100	ILL32CPG 121
AL190RBP 80	BK45BB 243	BUL111CMBP 48	CBL22RBP 100	ILL33CB 122
AL45PWTB..... 251	BK45BBP 243	BUL12CB 51	DH55 250	ILL33CBP 122
AL45PWTBP 251	BK53BB 236	BUL12CBP 51	DH55P 250	ILL35CB 121
AL46AB 95	BK53BBP 236	BUL12CFB..... 51	DL16CB 198	ILL36CB 122
AL46ABP 95	BK5557GB 236	BUL12CFBP 51	DL16CC 198	ILL36CBP 122
AL46RB 95	BK5557GBP 236	BUL12CFMB 51	DL16WC 198	ILL39CB 119
AL46RBP 95	BK55BB 238	BUL12CFMBP 51	DL55CS 198	ILL39CBP 119
AL82AB 81	BK55BBP 238	BUL13CB 109	DLL25WC 133	ILL70ABAWN..... 124
AL82ABP 81	BK57BB 238	BUL13CBP 109	DLL50CB..... 133	ILL70ABBAWN.... 124
AL82CAB 81	BK57BBP 238	BUL22CB 52	DLL50CBP 133	ILL70CB 123
AL82CRB 81	BK61AB..... 162	BUL22CBP 52	DLL50CC..... 133	ILL70CBAWN..... 124
AL82RB 81	BK66DB..... 247	BUL23C24B 49	DLL50WC 133	ILL70CBBAWN ... 124
AL82RBP 81	BK66DBP 247	BUL23C24BP 49	HLL88LB 2	ILL70CBP 123
AL90AB 82	BK70BB 245	BUL23CB 49	HLL88LBP 2	ILL70CBSBAWN.. 124
AL90ABP 82	BK70BBP 245	BUL23CBP 49	HLL89HB 2	ILL70CCSBAWN. 124
AL90AK 82	BU11CS 153	BUL35CB 53	HLL89HBP 2	ILL70CSB 123
AL90AS 82	BU31CB 153	BUL35CBP 53	HLL90HLB..... 3	ILL71ABAWN..... 124
AL90RB 82	BU31CBP 153	BUL43CB 109	HLL90HLBP 3	ILL71ABBAWN.... 124
AL90RBP 82	BU33CB 154	BUL43CBP 109	IL11CS 194	ILL71CB 123
AL90RK 82	BU33CBP 154	BUL52CB 52	IL21CB 194	ILL71CBAWN..... 124
AL90RS 82	BU33CRXLB 154	BUL52CBP 52	IL21CBP 194	ILL71CBBAWN ... 124
AL91AB 81	BU34CB 154	BUL53CB 49	IL21CPG 194	ILL71CBP 123
AL91ABP 81	BU34CBP 154	BUL53CBP 49	IL21CS 194	ILL71CSB..... 123
AL91CAB..... 81	BU41CB 153	BUL53CKB 49	IL22CB 194	ILL72CB 123
AL91CABP 81	BU41CBP 153	BUL53CKBP 49	IL22CBP 194	ILL72CBP 123
AL91RB 81	BU44CB 154	BUL69CB 110	IL31CS 195	ILL85CB 125
AL91RBP 81	BU44CBP 154	BUL69CBMVCB.. 110	IL41CB 195	ILL85CBP 125
ALEDFB..... 258	BU45CB 154	BUL69CBP 110	IL41CBP 195	ILL86CB 125
ALEDFBP..... 258	BU45CBP 154	BUL69CPG 110	IL61CB 196	ILL86CBP 125
APL1AB 204	BU49CB 154	BUL72CB 110	IL61CBP 196	ILL91CB 126
APL1ABP 204	BU49CBP 154	BUL72CBGK 110	IL91CB 196	ILL91CBP 126
APL1CB 204	BU64CB 154	BUL72CBGKP 110	IL91CBP 196	LM112CB..... 126
APL1CBP 204	BU64CBP 154	BUL72CBP 110	ILL01RB 117	LM112CBP 126
APL5AB 205	BU65CB 154	BUL73CB 111	ILL01RBP 117	LM315BB 126
APL5ABP 205	BU65CBP 154	BUL73CBP 111	ILL06COB 117	LM315BBP 126
APL5CB 205	BU70CB 154	BUL74CBK 110	ILL06COBP 117	LM835CB..... 126
APL5CBP 205	BU70CBP 154	BUL74CBKP 110	ILL08COB 118	LM835CBP 126
ARVIL35B..... 211	BU74CB 154	BUL74CBTK..... 110	ILL08COBP 118	LP10S 249
AST50B 202	BU74CBP 154	BUL74CBTKP..... 110	ILL08COPG 118	LP10SB..... 249
AST50B 202	BUL06CB 47	BUL78C3MB 111	ILL10CCB 118	LP10SBP..... 249
AST50BP 202	BUL06CBP 47	BUL78C3MBP 111	ILL10CCBP 118	LP11CB..... 183
AST50B 202	BUL06CFB..... 47	BUL78CB 111	ILL124CB 120	LP11CBP..... 183
AST55B 203	BUL06CFBP..... 47	BUL78CBP 111	ILL124CBP 120	LP11CPG..... 183
AST55BP 203	BUL06CFMB 47	BUL78CEZB..... 111	ILL21CB 119	LP11CPGP 183
AST56B 203	BUL06CFMBP 47	BUL90C24B 53	ILL21CBP 119	LP11CS 183
AST56BP 203	BUL101CB 46	BUL90C24BP 53	ILL21CTPB..... 119	LP15S 249
AST60B 200	BUL101CBP 46	BUL90CB 53	ILL22CB 120	LP15SB..... 249
AST60BP 200	BUL10CB 52	BUL90CBP 53	ILL22CBP 120	LP15SBP..... 249

INDEX

LP20SB..... 249	LPL31CB..... 106	MC32ABB..... 168	MC53RB..... 159	MC70ABP..... 174
LP20SBP..... 249	LPL31CBP..... 106	MC32ABP..... 168	MC53RBP..... 159	MC70RB..... 174
LP21CB..... 183	LPL31CEZB..... 106	MC32RB..... 168	MC53RS..... 159	MC70RBP..... 174
LP21CBP..... 183	LPL31CEZBP..... 106	MC32RBB..... 168	MC54AB..... 159	MC71AS..... 175
LP21CS..... 183	LPL31CS..... 106	MC32RBP..... 168	MC54ABP..... 159	MC71RS..... 175
LP25SB..... 250	LPL31CSB..... 106	MC35AB..... 169	MC54RB..... 159	MC76AB..... 175
LP25SBP..... 250	LPL31CSBP..... 106	MC35ABP..... 169	MC54RBP..... 159	MC76ABP..... 175
LP25SGGB..... 250	LPL41CB..... 107	MC35AEB..... 169	MC55AB..... 160	MC77RB..... 180
LP25SGGBP..... 250	LPL41CBP..... 107	MC35AEBP..... 169	MC55ABKP..... 160	MC77RBP..... 180
LP26SKB..... 190	LPL42CBF..... 107	MC35AS..... 169	MC55ABP..... 160	MC81AB..... 176
LP26SKBP..... 190	LPL55CB..... 107	MC35RS..... 169	MC55RB..... 160	MC81ABP..... 176
LP31CB..... 184	LPL55CBP..... 107	MC36AB..... 169	MC55RBKP..... 160	MC81AS..... 176
LP31CBP..... 184	LPL55CKB..... 107	MC36ABP..... 169	MC55RBP..... 160	MC81RB..... 176
LP31CPG..... 184	LPL55CKBP..... 107	MC36AS..... 169	MC56AB..... 161	MC81RBP..... 176
LP31CPGP..... 184	LPL55CPG..... 107	MC36RB..... 169	MC56ABP..... 161	MC81RS..... 176
LP31CS..... 184	LPL55CPGP..... 107	MC36RBP..... 169	MC56RB..... 161	MC82AB..... 176
LP31SB..... 249	LPL56CB..... 107	MC36RS..... 169	MC56RBP..... 161	MC82ABP..... 176
LP31SBP..... 249	LPL56CBP..... 107	MC37AB..... 170	MC57AB..... 160	MC82RB..... 176
LP35BB..... 250	LPL91CAB..... 108	MC37ABP..... 170	MC57ABP..... 160	MC82RBP..... 176
LP35BBP..... 250	LPL91CABP..... 108	MC38AB..... 170	MC57AS..... 160	MC85AB..... 177
LP41CB..... 185	LPL91CB..... 108	MC38ABP..... 170	MC57RB..... 160	MC85ABP..... 177
LP41CBP..... 185	LPL91CBKB..... 108	MC38RB..... 170	MC57RBP..... 160	MC90AS..... 165
LP41CS..... 185	LPL91CBKBP..... 108	MC38RBP..... 170	MC57RS..... 160	MC90RS..... 165
LP51CB..... 185	LPL91CBP..... 108	MC42AB..... 171	MC58AS..... 173	MC91AB..... 165
LP51CBP..... 185	LPL91CKALPB..... 108	MC42ABP..... 171	MC58RS..... 173	MC91ABP..... 165
LP52CB..... 186	LPL91CKALPBP..... 108	MC42AS..... 171	MC59AFB..... 161	MC91AS..... 165
LP52CBP..... 186	LPL91CKB..... 108	MC42RB..... 171	MC59AFBP..... 161	MC91RS..... 165
LP52HP..... 186	LPL91CKBP..... 108	MC42RBP..... 171	MC59RFB..... 161	MC92AB..... 165
LP52HPP..... 186	LPL91CPG..... 108	MC42RS..... 171	MC59RFBP..... 161	MC92ABP..... 165
LP54CB..... 186	LPL91CPGP..... 108	MC441WB..... 172	MC61ABKB..... 162	MC92AS..... 165
LP54CBP..... 186	MC11AB..... 166	MC441WBP..... 172	MC61ABKBP..... 162	MC92RB..... 165
LP55CB..... 186	MC11ABP..... 166	MC442WB..... 172	MC65AB..... 164	MC92RBP..... 165
LP55CBP..... 186	MC11AK..... 166	MC442WBP..... 172	MC65ABP..... 164	MC92RS..... 165
LP56CB..... 187	MC11AS..... 166	MC44AB..... 172	MC65ARB..... 163	MC93AB..... 180
LP56CBP..... 187	MC11RB..... 166	MC44AB1..... 172	MC65ARBP..... 163	MC93ABP..... 180
LP55B..... 249	MC11RBP..... 166	MC44AB1P..... 172	MC65RB..... 164	MC93R2PG..... 180
LP55BP..... 249	MC11RS..... 166	MC44ABP..... 172	MC65RBP..... 164	MC93R2PGP..... 180
LP65CB..... 187	MC21AS..... 167	MC44AS..... 172	MC66AB..... 173	MC93RB..... 180
LP65CBP..... 187	MC21RS..... 167	MC44RB..... 172	MC66ABP..... 173	MC93RBP..... 180
LP71CB..... 188	MC22AB..... 167	MC44RB1..... 172	MC66AS..... 173	MC93RK..... 180
LP71CBP..... 188	MC22ABP..... 167	MC44RB1P..... 172	MC66HAB..... 173	MC93RPG..... 180
LP81BB..... 188	MC22RB..... 167	MC44RBP..... 172	MC66HABP..... 173	MC93RPGP..... 180
LP81BBP..... 188	MC22RBP..... 167	MC44RS..... 172	MC66RB..... 173	MC94RB..... 181
LP81BPG..... 188	MC25AB..... 157	MC48AB..... 171	MC66RBP..... 173	MC94RBP..... 181
LP85CB..... 190	MC25ABP..... 157	MC48ABP..... 171	MC66RS..... 173	MC95AB..... 177
LP85CBP..... 190	MC25RB..... 157	MC48APG..... 171	MC67AB..... 164	MC95ABP..... 177
LP85CEZB..... 190	MC25RBP..... 157	MC48RPG..... 171	MC67ABP..... 164	MC95APG..... 177
LP85CEZBP..... 190	MC27AB..... 157	MC505ABSB..... 159	MC67AK..... 164	MC95AS..... 177
LP91CB..... 190	MC27ABP..... 157	MC505ABSBP..... 159	MC67ARB..... 163	MC95RB..... 177
LP91CBP..... 190	MC27RB..... 157	MC52AB..... 158	MC67ARBP..... 163	MC95RBP..... 177
LP95CBF..... 189	MC27RBP..... 157	MC52ABP..... 158	MC67RB..... 164	MC95RPG..... 177
LP97CB..... 189	MC30AB..... 166	MC52AXB..... 158	MC67RBP..... 164	MC95RS..... 177
LP97CBP..... 189	MC30ABP..... 166	MC52AXBP..... 158	MC67RK..... 164	MC97R70PG..... 181
LPB31CPG..... 184	MC31A15B2..... 168	MC52RB..... 158	MC68AB..... 174	MC97RB..... 181
LPB31CPGP..... 184	MC31AB..... 168	MC52RBP..... 158	MC68ABP..... 174	MC97RBP..... 181
LPL12CB..... 105	MC31ABP..... 168	MC52RXB..... 158	MC68AS..... 174	MC97RK..... 181
LPL12CBP..... 105	MC31AS..... 168	MC52RXBP..... 158	MC68RB..... 174	MC97RPG..... 181
LPL12CKM2B..... 105	MC31R15B2..... 168	MC53AB..... 159	MC68RBP..... 174	MC97RPGP..... 181
LPL12CKMB..... 105	MC31RB..... 168	MC53ABP..... 159	MC68RS..... 174	MC97RTTG..... 181
LPL12CPGB..... 105	MC31RBP..... 168	MC53ABSB..... 159	MC69AB..... 174	MC99AB..... 182
LPL26SKB..... 108	MC31RS..... 168	MC53ABSBP..... 159	MC69ABP..... 174	MC99ABP..... 182
LPL26SKBP..... 108	MC32AB..... 168	MC53AS..... 159	MC70AB..... 174	MC99AK..... 182

MC99RB..... 182	MCL11RB 65	MCL13RS..... 88	MCL19CAB..... 91	MCL48CABP..... 96
MC99RBP..... 182	MCL11RBP 65	MCL13RTRS..... 88	MCL19CABP..... 91	MCL49AB..... 95
MC99RK..... 182	MCL11RHFG..... 65	MCL14AB..... 89	MCL19CRB..... 91	MCL49ABP..... 95
MCL110AB..... 62	MCL11RK12B..... 65	MCL14ABF..... 89	MCL19CRBP..... 91	MCL50AB..... 72
MCL110ABP..... 62	MCL11RK12PG.... 65	MCL14ABFP..... 89	MCL19RB..... 91	MCL50ABP..... 72
MCL110AKB..... 62	MCL11RKAB..... 65	MCL14AB..... 89	MCL19RBP..... 91	MCL50RB..... 72
MCL110AKBP..... 62	MCL11RKB..... 65	MCL14AGB..... 89	MCL21AB..... 68	MCL50RBP..... 72
MCL110RB..... 62	MCL11RKB..... 65	MCL14AGBP..... 89	MCL21ABP..... 68	MCL51AB..... 77
MCL110RBP..... 62	MCL11RKB..... 65	MCL14AGPB..... 89	MCL21RB..... 68	MCL51ABP..... 77
MCL110RKB..... 62	MCL11RKB..... 65	MCL14AGPBP..... 89	MCL21RBP..... 68	MCL51RB..... 77
MCL110RKBP..... 62	MCL11RKBSSP..... 65	MCL14CABF..... 89	MCL22RK3B..... 104	MCL51RBP..... 77
MCL111AB..... 63	MCL11RKPVG..... 65	MCL14CABFP..... 89	MCL22RK3BP..... 104	MCL527AB..... 76
MCL111ABP..... 63	MCL11RPG..... 65	MCL14CRBF..... 89	MCL23AB..... 68	MCL527ABP..... 76
MCL111AKB..... 63	MCL11RPGP..... 65	MCL14CRBFP..... 89	MCL23ABP..... 68	MCL527AK..... 76
MCL111AKBP..... 63	MCL121AK9PVG..... 63	MCL14RB..... 89	MCL23RB..... 68	MCL527AS..... 76
MCL111AKFPG..... 63	MCL121AK9PVG..... 63	MCL14RBF..... 89	MCL23RBP..... 68	MCL527RB..... 76
MCL111AKFPGP..... 63	MCL121RK9PVG..... 63	MCL14RFBP..... 89	MCL31AB..... 92	MCL527RBP..... 76
MCL111AKPG..... 63	MCL121RK9PVG..... 63	MCL14RBP..... 89	MCL31ABP..... 92	MCL527RK..... 76
MCL111AKPGP..... 63	MCL122RK3B..... 104	MCL14RGB..... 89	MCL31RB..... 92	MCL527RS..... 76
MCL111RB..... 63	MCL122RK3BP..... 104	MCL14RGBP..... 89	MCL31RBP..... 92	MCL52AB..... 73
MCL111RBP..... 63	MCL12A2RLB..... 67	MCL155AB..... 69	MCL32AB..... 92	MCL52ABP..... 73
MCL111RKB..... 63	MCL12A2RRB..... 67	MCL155ABP..... 69	MCL32ABB..... 92	MCL52AMB..... 73
MCL111RKB..... 63	MCL12AB..... 66	MCL155AFB..... 69	MCL32ABBP..... 92	MCL52RB..... 73
MCL111RKB..... 63	MCL12ABP..... 66	MCL155AFBP..... 69	MCL32ABP..... 92	MCL52RBP..... 73
MCL111RKFPG..... 63	MCL12AK..... 66	MCL155RB..... 69	MCL32RB..... 92	MCL52RMB..... 73
MCL111RKFPGP..... 63	MCL12AK156PG..... 66	MCL155RBP..... 69	MCL32RBB..... 92	MCL54AB..... 73
MCL111RKPG..... 63	MCL12AKB..... 66	MCL155RFB..... 69	MCL32RBBP..... 92	MCL54ABP..... 73
MCL111RKPGP..... 63	MCL12AKBP..... 66	MCL155RFBP..... 69	MCL32RBP..... 92	MCL54RB..... 73
MCL112AB..... 64	MCL12AKPG..... 66	MCL157AB..... 74	MCL35A32G..... 93	MCL54RBP..... 73
MCL112ABP..... 64	MCL12ARLB..... 67	MCL157ABP..... 74	MCL35A32GP..... 93	MCL55A1224B..... 70
MCL112AKB..... 64	MCL12ARLB..... 67	MCL157RB..... 74	MCL36AB..... 93	MCL55AB..... 70
MCL112AKBP..... 64	MCL12ARRB..... 67	MCL157RBP..... 74	MCL36ABP..... 93	MCL55ABP..... 70
MCL112RB..... 64	MCL12ARRBP..... 67	MCL15AKPG..... 90	MCL36APG..... 93	MCL55ACB..... 70
MCL112RBP..... 64	MCL12CARLB..... 67	MCL15AKPGP..... 90	MCL36APGP..... 93	MCL55ACBP..... 70
MCL112RKB..... 64	MCL12CARRB..... 67	MCL15APG..... 90	MCL36AS..... 93	MCL55AK..... 70
MCL112RKB..... 64	MCL12RB..... 66	MCL15APGP..... 90	MCL36RB..... 93	MCL55AKB..... 70
MCL11AB..... 65	MCL12RBP..... 66	MCL15RKPG..... 90	MCL36RBP..... 93	MCL55FRB..... 70
MCL11ABP..... 65	MCL12RK..... 66	MCL15RKPGP..... 90	MCL40AB..... 94	MCL55R1224B..... 70
MCL11AHPG..... 65	MCL12RK156PG..... 66	MCL15RPG..... 90	MCL40AB1..... 94	MCL55RB..... 70
MCL11AK12B..... 65	MCL12RK3B..... 104	MCL15RPGP..... 90	MCL40ABP..... 94	MCL55RBP..... 70
MCL11AK12PG..... 65	MCL12RK3BP..... 104	MCL165AB..... 83	MCL40RB..... 94	MCL55RCB..... 70
MCL11AKAB..... 65	MCL12RK3RMB..... 104	MCL165ABP..... 83	MCL40RB1..... 94	MCL55RCBP..... 70
MCL11AKABP..... 65	MCL12RK3RMBP..... 104	MCL165RB..... 83	MCL40RBP..... 94	MCL55RK..... 70
MCL11AKB..... 65	MCL12RKB..... 66	MCL165RBP..... 83	MCL44AB..... 94	MCL55RKB..... 70
MCL11AKBF..... 65	MCL12RKB..... 66	MCL17AB..... 91	MCL44AB1..... 94	MCL56AB..... 71
MCL11AKBFP..... 65	MCL12RKBP..... 66	MCL17ABP..... 91	MCL44AB1P..... 94	MCL56ABP..... 71
MCL11AKBP..... 65	MCL12RKPG..... 66	MCL17APG..... 91	MCL44ABP..... 94	MCL56AK..... 71
MCL11AKBSSP..... 65	MCL131A2B..... 88	MCL17APGP..... 91	MCL44RB..... 94	MCL56AS..... 71
MCL11AKPVG..... 65	MCL131A2BP..... 88	MCL17CAB..... 91	MCL44RB1..... 94	MCL56RB..... 71
MCL11APG..... 65	MCL131R2B..... 88	MCL17CABP..... 91	MCL44RB1P..... 94	MCL56RBP..... 71
MCL11APGP..... 65	MCL13A2B..... 88	MCL17CRB..... 91	MCL44RBP..... 94	MCL56RK..... 71
MCL11CAB..... 65	MCL13A2BP..... 88	MCL17CRBP..... 91	MCL45AB..... 95	MCL56RS..... 71
MCL11CABP..... 65	MCL13A2MB..... 88	MCL17RB..... 91	MCL45ABP..... 95	MCL57A24B..... 75
MCL11CAKB..... 65	MCL13AS..... 88	MCL17RBP..... 91	MCL45RB..... 95	MCL57A24BP..... 75
MCL11CAKBF..... 65	MCL13ATRS..... 88	MCL17RPG..... 91	MCL45RBP..... 95	MCL57AB..... 75
MCL11CAKBP..... 65	MCL13CA2B..... 88	MCL17RPGP..... 91	MCL46AB..... 95	MCL57ABP..... 75
MCL11CAKPG..... 65	MCL13CA2BP..... 88	MCL190AB..... 80	MCL46ABP..... 95	MCL57ACB..... 75
MCL11CRB..... 65	MCL13CR2B..... 88	MCL190ABP..... 80	MCL46RB..... 95	MCL57ACBP..... 75
MCL11CRBP..... 65	MCL13CR2BP..... 88	MCL190RB..... 80	MCL46RBP..... 95	MCL57AK..... 75
MCL11CRKB..... 65	MCL13R2B..... 88	MCL190RBP..... 80	MCL48AB..... 96	MCL57AKB..... 75
MCL11CRKBF..... 65	MCL13R2BP..... 88	MCL19AB..... 91	MCL48ABP..... 96	MCL57R1224B..... 75
MCL11CRKBP..... 65	MCL13R2MB..... 88	MCL19ABP..... 91	MCL48CAB..... 96	MCL57R24B..... 75
MCL11CRKPG..... 65				

INDEX

MCL57R24BP 75	MCL66RB 97	MCL93RB 102	RE21RB 234	RVILL31P 210
MCL57RB 75	MCL66RBP 97	MCL93RBP 102	RE21RBP 234	RVILL31PB 210
MCL57RBP 75	MCL66RPG 97	MCL93RK 102	RE21RS 234	RVILL31PGB 210
MCL57RCB 75	MCL67AB 84	MCL93RPG 102	RE21T 231	RVILL32 210
MCL57RCBP 75	MCL67ABP 84	MCL93RPGP 102	RE31AS 234	RVILL32P 210
MCL57RK 75	MCL67ARB 87	MCL95A24B 100	RE31RS 234	RVILL33 209
MCL57RKB 75	MCL67ARBP 87	MCL95A24BP 100	RE35AB 234	RVILL33P 209
MCL58AB 78	MCL67RB 84	MCL95AB 100	RE35ABP 234	RVILL34 209
MCL58ABP 78	MCL67RBP 84	MCL95ABF 100	RE35RB 234	RVILL34P 209
MCL58ACB 78	MCL70RB 101	MCL95ABFP 100	RE35RBP 234	RVILL39 208
MCL58ACBP 78	MCL70RBF2 101	MCL95ABP 100	RE37AB 234	RVILL39P 208
MCL58RB 78	MCL70RBP 101	MCL95AS 100	RE37ABP 234	RVIM46 213
MCL58RBP 78	MCL70RCB 101	MCL95RB 100	RE37RB 234	RVIM46P 213
MCL59AB 79	MCL70RCBP 101	MCL95RBF 100	RE37RBP 234	RVPL1A 204
MCL59ABP 79	MCL70RS 101	MCL95RBF 100	RE418T 231	RVPL1AP 204
MCL59RB 79	MCL71RB 97	MCL95RBP 100	RE52ARK 233	RVPL1C 204
MCL59RBP 79	MCL71RBP 97	MCL95RS 100	RT150WBD 231	RVPL1CP 204
MCL61AB 85	MCL73AB 96	MCL96AB 81	RT150WBDP 231	RVPL3C 204
MCL61ABP 85	MCL73ABP 96	MCL96ABP 81	RT150Y1B 232	RVPL3CP 204
MCL61AK 85	MCL73RB 96	MCL96RB 81	RT150Y1BP 232	RVPL5A 205
MCL61AR26BK 87	MCL73RBP 96	MCL96RBP 81	RT150Y1DB 232	RVPL5AB 205
MCL61ARB 87	MCL75AB 84	MCL97RB 103	RT150Y1DBP 232	RVPL5ABP 205
MCL61ARBP 87	MCL75ABP 84	MCL97RBP 103	RT150Y2B 232	RVPL5AP 205
MCL61AS 85	MCL75RB 84	MCL97RK 103	RT150Y2BP 232	RVPL5C 205
MCL61RB 85	MCL75RBP 84	MCL97RPG 103	RT150Y2DB 232	RVPL5CB 205
MCL61RBP 85	MCL76AB 98	MCL98RB 104	RT150Y2DBP 232	RVPL5CBP 205
MCL61RK 85	MCL76ABP 98	MCL98RBP 104	RTR03150711CB 231	RVPL5CP 205
MCL61RS 85	MCL76RB 98	QH16CTS 199	RTR1015066CB... 231	RVPL7A 205
MCL63AB 86	MCL76RBP 98	QH16CTSP 199	RTR10150711CB 231	RVPL7AB 205
MCL63ABP 86	MCL77AB 84	QH36CTS 199	RTR10150WB 231	RVPL7ABP 205
MCL63CAB 86	MCL77ABP 84	QH36CTSP 199	RTR15066B 231	RVPL7AP 205
MCL63CABP 86	MCL77RB 84	RB10A 182	RTR15066BP 231	RVPL7C 205
MCL63CRB 86	MCL77RBP 84	RB10R 182	RTR15066PB 231	RVPL7CB 205
MCL63CRBP 86	MCL78RB 101	RC 229	RTR15066PBP 231	RVPL7CBP 205
MCL63RB 86	MCL78RBP 101	RCP 229	RTR150711B 231	RVPL7CP 205
MCL63RBP 86	MCL81AB 99	RE10AB 233	RTR150711BP 231	RVPL8AB 206
MCL65A24B 84	MCL81ABP 99	RE10ABP 233	RTR150711PB 231	RVPL8ABP 206
MCL65A24BP 84	MCL81RB 99	RE10AK 233	RTR150711PBP 231	RVPL8C 206
MCL65AB 84	MCL81RBP 99	RE10RB 233	RTRE150GB 232	RVPL8CB 206
MCL65ABP 84	MCL83RB 102	RE10RBP 233	RTRE150OB 232	RVPL8CBP 206
MCL65ARB 87	MCL83RBP 102	RE10RK 233	RTRE150RB 232	RVPL8CP 206
MCL65ARBP 87	MCL83RK 102	RE11AB 233	RV50BK 202	RVPL9CC 206
MCL65CAB 84	MCL84RB 103	RE11ABP 233	RV50BKP 202	RVPL9CCP 206
MCL65CABP 84	MCL84RBP 103	RE11RB 233	RV60BK 200	RVSL21 207
MCL65CARB 87	MCL85AB 98	RE11RBP 233	RV60BKP 200	RVSL21P 207
MCL65CARBP 87	MCL85ABP 98	RE12AK 233	RVBST55 203	RVSL31 207
MCL65CRB 84	MCL86AB 99	RE12ARK 233	RVBST55P 203	RVSL31P 207
MCL65CRBP 84	MCL86ABP 99	RE12RK 233	RVBST56 203	RVST50 202
MCL65R24B 84	MCL86RB 99	RE13AB 234	RVBST56P 203	RVST50P 202
MCL65R24BP 84	MCL86RBP 99	RE13ABP 234	RVC100 213	RVST51 202
MCL65RB 84	MCL88RCB 101	RE13RB 234	RVC100P 213	RVST51P 202
MCL65RBP 84	MCL88RCBP 101	RE13RBP 234	RVFL51 213	RVST55 203
MCL66A24B 97	MCL90AS 81	RE15AB 233	RVFL51P 213	RVST55P 203
MCL66A24BP 97	MCL90RS 81	RE15ABP 233	RVIL21 212	RVST56 203
MCL66AB 97	MCL91AB 81	RE15AK 233	RVIL21P 212	RVST56P 203
MCL66ABP 97	MCL91ABP 81	RE15RB 233	RVIL22 212	RVST60 201
MCL66APG 97	MCL91AK 81	RE15RBP 233	RVIL22P 212	RVST60P 201
MCL66APGP 97	MCL91RB 81	RE15RK 233	RVIL35 211	RVST61 201
MCL66CAB 97	MCL91RBP 81	RE18T 231	RVIL35P 211	RVST61P 201
MCL66CRB 97	MCL91RK 81	RE21AB 234	RVIL36 211	RVSTB50 202
MCL66CRBP 97	MCL922RB 104	RE21ABP 234	RVIL36P 211	RVSTB50P 202
MCL66R24B 97	MCL922RBP 104	RE21AS 234	RVILL31 210	RVSTB51 202
MCL66R24BP 97				

RVSTB51P 202	ST37RPGP 149	ST6RS 145	STL111ACBP 13	STL179RB 28
RVSTB60 201	ST37RS 149	ST70AB 135	STL111RB 13	STL17RB 42
RVSTB60P 201	ST3RB 146	ST70ABP 135	STL111RBP 13	STL17RBP 42
RVSTB61 201	ST3RBP 146	ST70RB 135	STL111RCB 13	STL17RS 42
RVSTB61P 201	ST40RB 137	ST70RBP 135	STL111RCBP 13	STL190AB 32
RVSTL60 200	ST40RBP 137	ST70RBTk 135	STL111RCFB 14	STL190ABP 32
RVSTL60P 200	ST40RS 137	ST70RBTkP 135	STL111RCFBP 14	STL190RB 32
RVSTL61 200	ST42RB 137	ST70RK 135	STL111RCFMB 14	STL190RBP 32
RVSTL61P 200	ST42RBP 137	ST70RS 135	STL111RCFMBP 14	STL22AB 19
RVSTLB60 200	ST42RPG 137	ST74AB 135	STL111RCMB 13	STL22ABP 19
RVSTLB60P 200	ST44AB 134	ST74ABP 135	STL111RCMBP 13	STL22CCAB 19
RVSTLB61 200	ST44ABP 134	ST74RB 135	STL111RFB 14	STL22CCABP 19
RVSTLB61P 200	ST44RB 134	ST74RBP 135	STL111RFBP 14	STL22CCRB 19
SLL43AB1 54	ST44RBP 134	ST75AB 135	STL111RFMB 14	STL22CCRBp 19
SLL43AB1P 54	ST45AB 134	ST75ABP 135	STL111RFMBP 14	STL22RB 19
SLL43AB2 54	ST45ABP 134	ST77AB 135	STL111RHB 13	STL22RBH 19
SLL43AB2P 54	ST45RB 134	ST77ABP 135	STL111RHBP 13	STL22RBHP 19
SLL43AKB1 54	ST45RBP 134	ST7RB 145	STL111RMB 13	STL22RBP 19
SLL43AKB1P 54	ST45RGB 134	ST7RBP 145	STL111RMBP 13	STL22RCB 19
SLL43AKB2 54	ST45RGBP 134	ST7RPG 145	STL116RB 40	STL22RCBP 19
SLL43AKB2P 54	ST45RK 134	ST7RS 145	STL116RBP 40	STL23A24B 10
SLL72AB1 55	ST45RS 134	ST8RB 144	STL117RB 40	STL23A24BP 10
SLL72AB1P 55	ST46RB 134	ST8RBP 144	STL117RBP 40	STL23AB 10
SLL72AB2 55	ST46RBP 134	ST8RS 144	STL12RB 18	STL23ABP 10
SLL72AB2P 55	ST46RKB 134	ST90AB 138	STL12RBP 18	STL23CCRB 10
SLL72AKB1 55	ST46RKBp 134	ST90ABP 138	STL12RK 18	STL23CCRBp 10
SLL72AKB1P 55	ST47RB 134	ST90RB 138	STL12RMB 18	STL23R24B 10
SLL72AKB2 55	ST47RBP 134	ST90RBP 138	STL12RMBP 18	STL23R24BP 10
SLL72AKB2P 55	ST47RKB 134	ST92AB 139	STL12RS 18	STL23RB 10
ST16RB 148	ST47RKBp 134	ST92ABP 139	STL13RB 9	STL23RBP 10
ST16RBP 148	ST4RB 147	ST92RB 139	STL13RBP 9	STL26RB 43
ST16RS 148	ST4RBP 147	ST92RBP 139	STL13RFB 9	STL26RBP 43
ST17RB 148	ST4RS 147	ST9RB 144	STL13RFBP 9	STL27RB 43
ST17RBP 148	ST51RB 141	ST9RBP 144	STL13RFMB 9	STL27RBP 43
ST17RS 148	ST51RBP 141	ST9RS 144	STL13RFMBP 9	STL28RB 39
ST20RS 143	ST51RS 141	STL101AB 4	STL13RGB 9	STL28RBP 39
ST21RS 143	ST52AA 141	STL101ABP 4	STL13RGBP 9	STL29RB 39
ST24RB 142	ST52AAP 141	STL101ACB 4	STL13RH1B 9	STL29RBP 39
ST24RBP 142	ST52RA 141	STL101ACBP 4	STL13RH1BP 9	STL2RB 38
ST25RB 142	ST52RB 141	STL101RB 4	STL13RH3B 9	STL2RBP 38
ST25RBP 142	ST52RBP 141	STL101RBP 4	STL13RH3BP 9	STL33RB 24
ST26RPG 148	ST53AAB 141	STL101RCB 4	STL13RK 9	STL33RBP 24
ST27RPG 148	ST53AABP 141	STL101RCBP 4	STL13RMB 9	STL33RFB 24
ST2RB 146	ST56RS 150	STL101RCFB 5	STL13RMBP 9	STL33RFBP 24
ST2RBP 146	ST57RS 150	STL101RCFBP 5	STL13RS 9	STL34RB 24
ST31RB 140	ST5RB 147	STL101RCFMB 5	STL14RB 41	STL34RBP 24
ST31RBP 140	ST5RBP 147	STL101RCFMBP 5	STL14RBP 41	STL35AB 25
ST31RS 140	ST5RS 147	STL101RCMB 4	STL15RB 41	STL35ABP 25
ST33AB 136	ST60RB 151	STL101RCMBP 4	STL15RBP 41	STL35RB 25
ST33ABP 136	ST60RBP 151	STL101RFB 5	STL161RB 34	STL35RBP 25
ST33RB 136	ST60RS 151	STL101RFBP 5	STL161RBP 34	STL36RB 44
ST33RBP 136	ST64RB 135	STL101RFMB 5	STL161RLB 34	STL36RBP 44
ST34RB 136	ST64RBP 135	STL101RFMBP 5	STL161RLBP 34	STL36RPG 44
ST34RBP 136	ST65RB 135	STL101RMB 4	STL16RB 42	STL36RPGP 44
ST36RB 149	ST65RBP 135	STL101RMBP 4	STL16RBP 42	STL36RS 44
ST36RBP 149	ST66RPG 149	STL108RB 36	STL16RS 42	STL37RB 44
ST36RPG 149	ST66RPGP 149	STL108RBP 36	STL178RB 15	STL37RBP 44
ST36RPGP 149	ST67RPG 149	STL109RB 36	STL178RBP 15	STL37RPG 44
ST36RS 149	ST67RPGP 149	STL109RBP 36	STL178RCB 15	STL37RPGP 44
ST37RB 149	ST6RB 145	STL111AB 13	STL178RCBP 15	STL37RS 44
ST37RBP 149	ST6RBP 145	STL111ABP 13	STL178RFBP 15	STL3RB 38
ST37RPG 149	ST6RPG 145	STL111ACB 13	STL178RFBP 15	STL3RBP 38

INDEX

STL42AB..... 7	STL63CRB 26	STL80RB 29	TLL44FBP 127	UCL60CSCB..... 115
STL42ABP..... 7	STL63RB 26	STL80RBP 29	TLL44FS 127	UCL60CSNB 115
STL42AMB 7	STL68RB 26	STL82RCB 16	TLL45FB 127	UCL65CB..... 116
STL42AMBP 7	STL68RBP 26	STL82RCBP 16	TLL45FBP..... 127	UCL65CBP 116
STL42RB 7	STL69CRPG 27	STL88RCB 17	TLL46CFB 128	UL11BS..... 166
STL42RBP 7	STL69RB 27	STL88RCBP 17	TLL46CFBP 128	UL53CB 193
STL42RMB 7	STL69RBP 27	STL88RCPG 17	TLL46TB 128	UL53CBP 193
STL42RMBP 7	STL69RCB 27	STL88RCPGP 17	TLL46TBP 128	UL56CB 193
STL43A24B..... 6	STL69RCBMCVB .. 27	STL89RCB 29	TLL48FB 129	UL71CS 192
STL43A24BP..... 6	STL69RCBP 27	STL89RCBP 29	TLL48FBP..... 129	UL94CB 191
STL43AB..... 6	STL69RRXB 27	STL8R3B 37	TLL50FB 129	UL94CBP 191
STL43ABP..... 6	STL69RRXBP 27	STL8RB 37	TLL50FBP..... 129	UL95CB 191
STL43ABX..... 8	STL69RRXBPG..... 27	STL8RBP 37	TLL50FS 129	UL95CBP 191
STL43ABXP 8	STL6RS..... 37	STL90A24B..... 33	TLL51FB 130	UL97CPG 192
STL43AKB..... 6	STL70AB..... 21	STL90A24BP..... 33	TLL51FBP..... 130	UL97CPGP 192
STL43AKBP..... 6	STL70ABP..... 21	STL90AB..... 33	TLL52FB 130	
STL43R24B 6	STL70RB 21	STL90ABP 33	TLL52FBP..... 130	
STL43R24BP 6	STL70RBP 21	STL90R24B 33	TLL52FS 130	
STL43RB 6	STL71AMB 22	STL90R24BP 33	TLL52FWB 130	
STL43RBHX..... 8	STL71AMBP 22	STL90RB 33	TLL52FWBP 130	
STL43RBP 6	STL72AB..... 16	STL90RBP 33	TLL54TB 131	
STL43RBX 8	STL72ABP..... 16	STL9R3B 37	TLL54TBP..... 131	
STL43RBXP..... 8	STL72AMB 16	STL9RB 37	TLL56FB 131	
STL43RK 6	STL72AMB 16	STL9RBP 37	TLL56FBP..... 131	
STL43RKB 6	STL72CAB..... 16	TL106CS..... 197	TLL56RK 45	
STL43RKBP 6	STL72CABP..... 16	TL10C24VB..... 197	TLL57FB 131	
STL43RM24B 6	STL72RB 16	TL10CB 197	TLL57FBP..... 131	
STL43RM24BP 6	STL72RBP 16	TL10CBP 197	TLL60FB 132	
STL43RMB 6	STL72RK 16	TL10CPG 197	TLL60FBP..... 132	
STL43RMBP 6	STL72RKB 16	TL10CS..... 197	TLL64FB 132	
STL52ARB 31	STL72RKB 16	TL10SS..... 197	TLL64FBP..... 132	
STL52ARBP 31	STL72RMB 16	TL11CPG 197	TLL80FB 133	
STL53ARDB 31	STL72RMBP 16	TL12CS..... 197	TLL80FBP..... 133	
STL53ARDBP 31	STL72RS..... 16	TL15RK 148	TLL80FWB 133	
STL53ARPB 31	STL73RB 18	TL16RK 148	TLL80FWBP 133	
STL53ARBP 31	STL73RBP 18	TL22RK 152	TLL90RK 37	
STL53RCB 6	STL74RBK 16	TL27BK 144	TLL9RK 37	
STL53RCBP 6	STL74RBKP 16	TL29BK 144	UCL09CB..... 112	
STL543RB 11	STL74RKB 16	TL35FS 197	UCL09CBB 112	
STL543RBP 11	STL74RKBP 16	TL35TB 197	UCL09CBBP 112	
STL55AB..... 12	STL75AB..... 23	TL35TS 197	UCL09CBP 112	
STL55ABP..... 12	STL75ABP..... 23	TL36RK 149	UCL11CB..... 112	
STL55RB 12	STL75AMB 23	TL46FS 197	UCL11CBP 112	
STL55RBP 12	STL75AMBP 23	TL46TS 197	UCL11CKB 112	
STL55RFMB 12	STL75AMFB..... 22	TL5RK 145	UCL11CKBP 112	
STL55RFMBP 12	STL75AMFBP..... 22	TL60RK 147	UCL11CKPG 112	
STL56RB 45	STL75HA1B 23	TL6RK 147	UCL11CKPGP ... 112	
STL56RBP 45	STL75HA1BP 23	TL8RK 144	UCL13C2PG 113	
STL572AB..... 20	STL76RB 30	TL9RK 145	UCL13C2PGP ... 113	
STL572ABP..... 20	STL76RBP 30	TLL112RK 13	UCL160CB..... 115	
STL572RB 20	STL78AB..... 17	TLL12RK 18	UCL160CBP 115	
STL572RBP 20	STL78ABP..... 17	TLL160RK 42	UCL19CB..... 113	
STL57RB 45	STL78ABP..... 17	TLL16RK 42	UCL19CBP 113	
STL57RBP 45	STL78RBP 17	TLL170RK 40	UCL50CB..... 114	
STL60RB 35	STL78REZB..... 17	TLL190RK 36	UCL50CBP 114	
STL60RBP 35	STL78REZBP 17	TLL22RK 19	UCL55CB..... 114	
STL60RLB..... 35	STL78RK 17	TLL25FS 133	UCL55CBP 114	
STL60RLBP 35	STL78RPG 17	TLL26RK 43	UCL60CB..... 115	
STL61RB 35	STL78RPGP 17	TLL28RK 39	UCL60CBP 115	
STL61RBP 35	STL79RB 29	TLL29RK 39	UCL60CBSC 115	
STL61RLB..... 35	STL79RBP 29	TLL36RK 44	UCL60CSBB..... 115	
STL61RLBP 35	STL7RS..... 37	TLL44FB 127	UCL60CSBBP..... 115	



optronics

One bright idea after another



For more information, scan this
QR code with your mobile device

www.optronicsinc.com

optronics

www.optronicsinc.com

2014-2015